



www.bihhr.eu

**Bihhr**  
Powering your passion

**DOCUMENTATION TECHNIQUE : Plaquettes de frein | Brake pads |** v12.09.2016

**Liste des applications motos et croquis | Pad drawings and their motorcycle applications**



## DOCUMENTATION TECHNIQUE : Plaquettes de frein | Brake pads | V12.09.2016

### Légende | Legend

#### SECTION 1 / SEZIONE 1 / SECTION 1 / TEIL 1 / SECCION 1

Application  
Applicazione  
Application  
Anwendung  
Aplicación

Production year  
Anno di produzione  
Année de production  
Produktion Jahr  
Año de producción

Equivalente all'originale  
Grassetto = ricambio originale  
Equivalent to original  
**Bold = original replacement part**  
Équivalent à l'original  
Gras = pièce de rechange d'origin  
Gleichwertig mit Originalteil  
Fettgedruckt = Originalbelag  
Equivalente al original  
Negrita = recambio original

Front axle  
Asse anteriore  
Essieu avant  
Vorderachse  
Eje delantero

Equivalente all'originale  
Grassetto = ricambio originale  
Equivalent to original  
**Bold = original replacement part**  
Équivalent à l'original  
Gras = pièce de rechange d'origin  
Gleichwertig mit Originalteil  
Fettgedruckt = Originalbelag  
Equivalente al original  
Negrita = recambio original

<b>AXY</b>					↓ CC	Genuine	SA	SD	SX	XS	SC	TT	RC	↓ CC	Genuine	SP	SD	SX	XS	TT	
150	GULP	07 >	N	07027	CC	CC								07039	CC	CC					
150	SLURP	08 >	N	07027	CC	CC								07039	CC	CC					
150	YUK	07 >	N	07027	CC	CC								07039	CC	CC					

Bi-disc  
Doppio disco  
Double disques  
Zwei Bremsscheiben  
Doble disco

Brake pad  
Pastiglia freno  
Plaquette de frein  
Scheibenbremsbelage  
Pastilla

Brake pad  
Pastiglia freno  
Plaquette de frein  
Scheibenbremsbelage  
Pastilla

Rear axle  
Asse posteriore  
Essieu arrière  
Hinterrachse  
Eje trasero

#### SECTION 2 AND 3 / SEZIONE 2 E 3 / SECTION 2 ET 3 / TEIL 2 UND 3 / SECCION 2 Y 3

Lunghezza pastiglia  
Pad length  
Longueur plaquette  
Laenge Belag  
Longitud de la pastilla

Altezza pastiglia  
Pad height  
Hauteur plaquette  
Höhe Belag  
Altura de la pastilla

Spessore pastiglia  
Pad thickness  
Epaisseur plaquette  
Dicke Belag  
Espesor de la pastilla

<b>07GR04.16</b>	85 x 42,5 x 6.5	85 x 42,5 x 6.5
<b>07GR04.SA</b>	" " "	" " "



**DOCUMENTATION TECHNIQUE : Plaquettes de frein | Brake pads |** v12.09.2016

**Liste des applications motos et croquis | Pad drawings and their motorcycle applications**



Racing - RC



Racing - SC



Off Road - SD



Road - SA



Off Road - TT



Genuine - Carbon Ceramic



Road - Carbon Ceramic



Off Road - SX



Genuine - Sinter



Road - SP



Scooter - XS



Scooter - Carbon Ceramic



**07BB01.06** 39.8 x 56.2 x 6.8

**07BB01.35** " " "  
GENUINE

**07BB01.SP** " " "

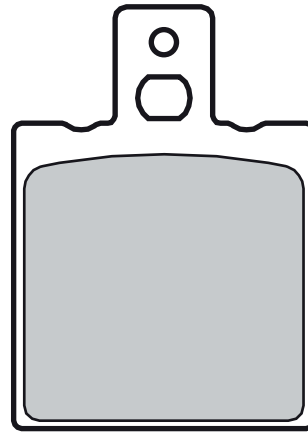

### ALFER

250 MC 87 > 87 •

### APRILIA

50 RS 93 > 95 •  
50 RS 96 > 99 •  
125 AF-1 EUROPA 89 > 91 •  
125 AF-1 FUTURA 89 > 91 •  
125 AF1 86 > •  
125 AF1 REPLICA, SINTESI 88 > 89 •  
125 RS EXTREMA 93 > 98 •  
125 RS REPLICA 93 > 97 •  
125 TUAREG RALLY 89 > 89 •  
125 TUAREG WIND 89 > 89 •  
350 RALLY 86 > •  
350 TUAREG 88 > •  
350 TUAREG WIND 87 > 87 •  
350 TUAREG WIND 88 > 89 •

### ASPES

125 SINTESI 88 > •

### BENELLI

125 2C SPORT 70 > •  
125 2C TURISMO 70 > •  
500 504 SPORT 76 > •  
650 654 83 > •  
650 654 SPORT 83 > •

### BIMOTA

400 YB 7 89 > •  
600 BELLARIA 90 > 92 •  
600 BELLARIA 93 > •  
600 YB 9 SR 97 > •  
600 YB 9 SRI 97 > •  
750 YB 4 88 > •  
851 TESI 91 > •  
900 DB2 93 > •  
900 DB2 SR 94 > •  
906 TESI 91 > •  
1000 DB 1 87 > 90 •  
1000 DB 1 91 > •  
1000 DB 1 RS 87 > •  
1000 FURANO 92 > •  
1000 TESI 2D 04 > 06 •

1000 TUATARA 90 > •  
1000 YB 6 87 > •  
1000 YB 8 89 > •  
1098 DB7 09 > •  
1100 SB6 94 > 96 •  
1200 YB 5 FS 87 > •

### CAGIVA

50 COCIS 89 > • •  
50 LUCKY EXPLORER 88 > •  
50 SUPER CITY 93 > •  
50 W4 92 > •  
80 COCIS 91 > •  
80 W4 92 > •  
125 CROSS 84 > 87 •  
125 CRUISER 87 > •  
125 ELEFANT 3 86 > •  
125 ENDURO 86 > •  
125 FRECCIA C10 88 > 89 •  
FRECCIA C10 ANNIVERSARY 89 > •  
125 FRECCIA C12 89 > •  
125 FRECCIA C9 88 > •  
125 MITO 90 > •  
125 MITO 2 92 > 93 •  
125 MITO 525 08 > •  
125 MITO EURO2 04 > •  
125 MITO EV 94 > 03 •  
125 PLANET 98 > 00 •  
125 RAPTOR 03 > 04 •  
125 RAPTOR 05 > •  
125 W8 92 > 98 •  
250 MXR 82 > •  
250 SST 81 > •  
250 SXT 83 > •  
250 WMX GP 82 > •  
350 ALA ROSSA 83 > •  
350 ELEFANT 85 > •  
350 SST 80 > •  
350 SXT 83 > •  
350 T4 87 > •  
350 T4 R 87 > •  
500 MITO 07 > •  
500 RIVER 99 > •  
500 T4 E 87 > •  
500 T4 R 87 > •  
500 WMX 85 > 86 •

525 SP MITO 08 > •  
600 RIVER 94 > •  
650 ALA AZZURRA 85 > • •  
650 ELEFANT 85 > 87 •  
750 ELEFANT 87 > • •

### DUCATI

350 XL 82 > •  
400 MONSTER 400 03 > 04 •  
500 PANTAH 77 > • •  
600 PANTAH 81 > •  
650 INDIANA 86 > •  
695 MONSTER 695 06 > •  
748 748 00 > 02 •  
748 748 BIPOSTO 98 > 98 •  
748 748 BIPOSTO 99 > •  
748 748 R 00 > •  
748 748 R 01 > 02 •  
748 748 S 00 > 02 •  
748 748 SPS 98 > 99 •  
750 PASO 87 > 88 •  
851 851 89 > •  
851 851 SP2 90 > •  
851 851 SP3 91 > •  
851 851 SUPERBIKE 91 > •  
888 888 RACING 92 > •  
900 SUPERSPORT 900 90 > 97 •  
916 916 94 > 96 •  
916 916 BIPOSTO SENNA 94 > 98 •  
916 916 S 94 > 96 •  
916 916 SP 94 > 96 •  
916 916 SPS 97 > •  
996 996 99 > •  
996 996 00 > •  
996 996 01 > •  
996 996 R 01 > •  
996 996 S 00 > •  
996 996 SPS 99 > •  
996 996 SPS II 99 > •  
996 996 SPS III 00 > •  
996 MONSTER S4 R 03 > 03 •  
998 998 02 > •  
998 998 F.E. 04 > •  
998 998 MATRIX 04 > •  
998 998 R 02 > •  
998 998 S 02 > •

**FRIGERIO PUCH**

125 F7	89 >	•
125 REPLAY	89 >	•
250 CROSS	84 > 85	•
250 REPLAY	89 >	•
350 HV	70 >	•

**GILERA**

125 CROSS	84 > 85	•
125 MXR	90 >	•
125 RX	83 >	•
200 RX	85 >	•
250 ARIZONA RALLY	70 >	•
250 CROSS	83 >	•
250 NGR	85 >	•

**HONDA**

125 NSR, F	88 > 89	•
------------	---------	---

**HUSQVARNA**

125 CR	84 > 86	•
240 CR	84 > 85	•
250 CR	84 > 86	•
250 CX	84 > 85	•

**KEEWAY**

125 ENDURO	07 >	•
125 X-RAY	07 >	•

**KRAMIT**

125 SCRAMBLER	70 >	•
---------------	------	---

**LAVERDA**

125 LZ	82 >	•
125 LZ (CU)	85 >	•
125 SP	82 >	•
125 ST	82 >	•
350 350	77 >	• •
500 500	77 >	• •
600 ATLAS	86 >	•

**MOTO GUZZI**

350 350	77 >	• •
350 NTX	88 > 89	•
350 NTX	90 >	•
350 V 35	84 >	• •
350 V 35 FLORIDA	87 >	•
350 V 35 II	84 >	• •
350 V 35 IMOLA	84 >	• •
350 V 35 POLIZIA	84 >	• •
350 V 35 TT	84 >	• •
500 V 50 C	80 >	• •
500 V 50 III	85 >	• •
500 V 50 MONZA	84 >	• •
500 V 50 POLIZIA	80 >	• •
650 NTX	87 >	•
650 V 65	86 >	•
650 V 65 FLORIDA	87 >	•
650 V 65 LARIO	87 >	•
750 TARGA	89 >	•
1000 DAYTONA	92 > 95	•
1000 DAYTONA RACING	92 > 96	•
1000 DAYTONA RS	97 > 98	•
1000 V10 CENTAURO	97 > 99	•
1000 V10 CENTAURO SPORT	98 > 99	•

1100 CALIFORNIA EV TOURING	01 > 05	•
1100 SPORT	94 > 96	•
1100 SPORT CORSA	98 > 99	•
1100 SPORT I.E.	96 > 99	•
1100 V11 BALLABIO	03 >	•
1100 V11 CAFE SPORT	03 >	•
1100 V11 COPPA ITALIA	04 >	•
1100 V11 LE MANS	01 > 02	•
1100 V11 LE MANS	01 >	•
1100 V11 LE MANS	03 >	•
1100 V11 NAKED	01 > 02	•
1100 V11 NAKED	03 >	•
1100 V11 SCURA	02 >	•
1100 V11 SPORT	01 > 02	•
1100 V11 SPORT ROSSO	01 >	•

**MOTO MORINI**

350 DART	87 > 87	•
350 DART	88 > 89	•
350 EXCALIBUR	87 >	•
400 DART	89 > 89	•
400 DART	90 >	•
501 COGUARO	89 >	•
501 EXCALIBUR	89 > 89	•
501 EXCALIBUR	90 >	•

**SWM**

500 4T	70 >	•
--------	------	---



**07BB02.35**  
GENUINE 77.9 x 41.2 x 9

**07BB02.58**  
GENUINE “ “ “

**07BB02.65**  
GENUINE “ “ “

**07BB02.SD** “ “ “

**07BB02.SX** “ “ “

**07BB02.TT** “ “ “

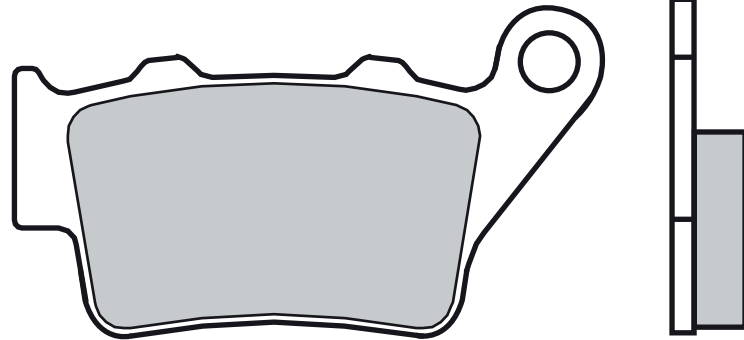

### ALFER

125 VRE - 4 STROKE	00 >	•
250 VR CROSS	99 >	•
250 VR ENDURO	99 >	•
250 VR NO LIMIT	99 >	•
250 VR SUPERMOTARD	99 >	•

### APRILIA

650 PEGASO	04 >	•
650 PEGASO I.E.	01 >	•
650 PEGASO STRADA	05 >	•
650 PEGASO TRAIL	06 >	•
660 PEGASO FACTORY	05 >	•
750 DORSODURO	09 >	•
750 DORSODURO ABS	09 >	•
750 DORSODURO FACTORY	12 >	•
750 SHIVER	07 >	•
750 SHIVER	09 >	•
750 SHIVER ABS	09 >	•
750 SHIVER GT	09 >	•
750 SHIVER GT ABS	09 >	•
750 SHIVER SL	07 >	•
750 SHIVER SL	09 >	•
750 SMV DORSODURO	08 > 08	•
750 SMV DORSODURO	08 >	•
850 MANA	07 > 07	•
1200 CAPONORD	13 >	•
1200 CAPONORD ABS	14 >	•
1200 CAPONORD TP	14 >	•
1200 DORSODURO	11 >	•
1200 DORSODURO ABS	11 >	•

### BENELLI

449 BX CROSS	07 >	•
449 BX SUPERMOTARD	08 >	•
505 ENDURO	08 >	•

### BETA

125 JONATHAN	99 >	•
350 EURO	99 >	•
350 JONATHAN	02 >	•

### BMW

313 G 310 R	16 >	•
650 F 650 CS	02 > 06	•
650 F 650 GS	01 >	•
650 F 650 GS ABS	00 > 07	•
650 F 650 GS DAKAR	01 > 07	•
650 F 650 GS RALLY	01 >	•
650 F 650 ST	93 > 00	•
650 G 650 GS	09 >	•
650 G 650 XCHALLENGE	07 >	•
650 G 650 XCOUNTRY	07 >	•
650 G 650 XMOTO	07 >	•
650 GS 650 SERTAO	12 >	•
700 F 700 GS	13 >	•
800 F 650 GS	08 >	•
800 F 700 GS	16 >	•
800 F 800 GS	08 > 15	•
800 F 800 GS	16 >	•
800 F 800 GS ADVENTURE	14 >	•
800 F 800 GT	13 >	•
800 F 800 R	09 > 14	•
800 F 800 R	15 >	•
800 F 800 S	06 >	•
800 F 800 S	09 >	•
800 F 800 ST	06 >	•
800 F 800 ST TOURING	11 >	•
1000 S 1000 R	13 >	•
1000 S 1000 R ABS	14 >	•
1000 S 1000 RR	09 >	•
1000 S 1000 RR HP4	12 > 14	•

### CCM

600 RS	01 >	•
600 SPORT	99 >	•
600 SUPERMOTO	99 >	•
644 DS	02 >	•
644 R30	02 >	•

### DUCATI

400 SCRAMBLER SIXTY2	16 >	•
803 SCRAMBLER FLAT TRACK PRO	16 >	•

803 SCRAMBLER ITALIAN INDEPENDENT	16 >	•
1000 GT 1000	07 >	•
1000 GT 1000 TOURING	09 >	•
1000 PAUL SMART 1000 L.E.	05 >	•
1000 SPORT 1000	05 > 06	•
1000 SPORT 1000 (BIPOSTO)	07 >	•
1000 SPORT 1000 (MONOPOSTO)	07 >	•
1000 SPORT 1000 S	07 >	•
1000 SPORT BIPOSTO	07 >	•

### GAS GAS

125 EC	97 > 99	•
200 EC	99 > 99	•
250 EC	97 > 99	•
250 MC	97 > 99	•
300 EC	99 > 99	•

### HIGHLAND

450 MX	06 >	•
950 V2	99 >	•

### HONDA

500 CB	97 >	•
500 CB S	98 >	•
650 NX DOMINATOR	97 > 99	•
650 SLR	97 >	•
650 VIGOR FX	99 > 02	•

### HRD

50 GS ENDURO	00 >	•
--------------	------	---

### HUSABERG

400 FC	99 >	•
400 FE	99 >	•
400 FS SUPERMOTARD	01 >	•
450 FC	03 >	•
450 FC (CROSS)	05 >	•
450 FE (ENDURO)	05 >	•
450 FE E	04 >	•
450 FSC SUPERMOTARD	03 >	•



450	FSE SUPERMOTARD	03 >	•
450	FX	03 >	•
470	FC	01 >	•
470	FX	01 >	•
550	FC	01 >	•
550	FC (CROSS)	05 >	•
550	FE (ENDURO)	05 >	•
550	FE E	04 >	•
600	FC	99 >	•
600	FE	99 >	•
650	FE (ENDURO)	05 >	•
650	FSC SUPERMOTARD	01 >	•
650	FSE SUPERMOTARD	01 >	•
650	FX	01 >	•

## HUSQVARNA

125	CR	95 > 98	•
125	CR	99 > 02	•
125	CR	03 > 04	•
125	SM	98 >	•
125	SM S	09 >	•
125	SM S 4T	11 >	•
125	SMS	00 > 01	•
125	SMS	05 >	•
125	WR	95 > 97	•
125	WR	98 > 02	•
125	WR	03 > 04	•
125	WR E	94 > 98	•
125	WR E	98 > 05	•
125	WR E	06 >	•
250	CR	95 > 98	•
250	CR	99 > 00	•
250	CR	01 > 01	•
250	CR	02 > 04	•
250	TC	02 > 03	•
250	TE	03 > 03	•
250	TE	04 >	•
250	WR	95 > 97	•
250	WR	98 > 00	•
250	WR	01 > 01	•
250	WR	02 >	•
350	TE	95 >	•
360	WR	95 > 98	•
360	WR	98 > 00	•
360	WR	01 > 01	•
360	WR	02 >	•
400	SM R	02 >	•
400	TE	01 >	•
410	TE	95 > 98	•
410	TE	99 > 00	•
410	TE E	00 > 01	•
449	TE 449	02 > 05	•
450	SMR	03 > 04	•
450	SMR	05 >	•
450	TC	03 > 03	•
510	SMR	05 > 05	•
510	TC	02 > 04	•
510	TE 511	05 > 05	•
510	TE R	04 >	•
570	NOX	01 > 03	•
570	R	01 >	•
570	SMR	01 > 02	•
570	SMR	03 > 04	•
570	SMR R	04 >	•

570	TC	02 >	•
570	TE	01 > 04	•
610	LT	00 >	•
610	SM	98 > 99	•
610	SM	05 >	•
610	SMS	00 > 01	•
610	SMS	03 > 04	•
610	SMS	06 >	•
610	TC	96 > 97	•
610	TC	98 > 98	•
610	TC	99 > 00	•
610	TE	96 > 97	•
610	TE	98 > 98	•
610	TE	99 > 00	•
610	TE E	98 > 99	•
610	TE E	00 > 01	•
610	TE E	03 > 04	•
610	TE E DUAL PURPOSE	06 >	•
610	TE E LT	99 > 99	•
610	TE E LT	00 >	•
630	SMR	04 >	•
630	SMS	10 >	•
630	TE	10 >	•
650	TR STRADA	13 >	•
650	TR TERRA	13 >	•
701	SUPERMOTO	15 >	•
900	NUDA	12 >	•
900	NUDA ABS	12 >	•
900	NUDA R	12 >	•

## HYOSUNG

450	RX SM	08 >	•
-----	-------	------	---

## KRAMIT

250	GS	97 >	•
250	MX	97 >	•
250	SM	97 >	•
250	SMR	00 >	•

## KTM

125	DUKE	11 > 14	•
125	EGS	94 > 97	•
125	EGS	98 > 98	•
125	EGS	99 >	•
125	EXC	94 > 97	•
125	EXC	98 > 98	•
125	EXC	99 > 99	•
125	EXC	00 > 00	•
125	EXC	01 > 03	•
125	EXE	00 > 01	•
125	LC2	96 > 98	•
125	RC	14 >	•
125	STING	99 >	•
125	SUPERMOTO	00 > 01	•
125	SX	94 > 97	•
125	SX	98 > 98	•
125	SX	99 > 00	•
125	SX	01 > 03	•
125	SXS	01 > 02	•
200	DUKE	12 > 14	•
200	EGS	98 > 98	•
200	EGS	99 >	•
200	EXC	98 > 98	•

200	EXC	99 > 00	•
200	EXC	01 > 03	•
200	MXC	98 >	•
200	MXC	99 > 00	•
200	MXC	01 > 03	•
200	RC	14 >	•
250	EGS	94 > 98	•
250	EGS	99 >	•
250	EXC	94 > 98	•
250	EXC	99 > 00	•
250	EXC	01 > 03	•
250	EXC RACING	03 > 04	•
250	GS	94 >	•
250	MXC	00 > 00	•
250	MXC	01 >	•
250	SX	94 > 98	•
250	SX	99 > 00	•
250	SX	01 > 02	•
250	SXS	01 >	•
300	EGS	94 > 98	•
300	EGS	99 >	•
300	EXC	94 > 98	•
300	EXC	99 > 00	•
300	EXC	01 > 03	•
300	MXC	97 > 98	•
300	MXC	99 > 00	•
300	MXC	01 > 03	•
300	SX	94 > 05	•
350	EXC	94 >	•
360	EGS	96 > 97	•
360	EXC	96 > 97	•
360	MXC	97 >	•
360	SX	96 > 97	•
380	EGS	98 >	•
380	EGS	99 >	•
380	EXC	98 >	•
380	EXC	99 >	•
380	EXC	00 >	•
380	EXC	01 > 02	•
380	MXC	98 >	•
380	MXC	99 >	•
380	MXC	00 >	•
380	MXC	01 >	•
380	SX	98 >	•
380	SX	99 > 00	•
380	SX	01 > 02	•
390	DUKE	13 > 14	•
390	RC	14 >	•
400	DUKE	94 > 95	•
400	EGS	94 > 97	•
400	EXC	94 > 96	•
400	EXC	00 >	•
400	EXC	01 > 02	•
400	LC4	98 > 01	•
400	MXC	02 >	•
400	SUPERMOTO	01 >	•
400	SX	98 >	•
400	SX	99 > 00	•
400	SX	01 > 02	•
400	SXC	97 >	•
440	SX	94 >	•
450	EXC	03 >	•
450	MXC	03 >	•
450	RALLY	11 >	•
450	SX	03 > 03	•



520	EXC	01 > 02	•
520	MXC	01 > 02	•
520	SX	00 > 00	•
520	SX	01 > 02	•
525	EXC	03 > 03	•
525	MXC	03 >	•
525	SX	03 > 03	•
540	SXC	99 >	•
540	SXS	01 > 02	•
550	MXC	96 >	•
620	ADVENTURE	97 >	•
620	DUKE 4T	94 > 97	•
620	EGS	94 > 97	•
620	EXC	94 >	•
620	LC4	98 > 99	•
620	LC4 RALLY DAKAR	97 >	•
620	SC	01 >	•
620	SUPERMOTO	01 >	•
620	SX	94 > 97	•
620	SX	98 > 98	•
620	SX	99 >	•
620	SXC	97 >	•
625	SC	02 >	•
625	SMC	05 >	•
625	SUPERMOTO	02 >	•
625	SXC	03 >	•
640	ADVENTURE TRAVELLER'S EDITION	07 >	•
640	DUKE	98 >	•
640	DUKE II	99 > 04	•
640	DUKE II	05 > 07	•
640	LC4	98 > 04	•
640	LC4	05 >	•
640	LC4 ADVENTURE	98 > 02	•
640	LC4 ADVENTURE	03 > 04	•
640	LC4 ADVENTURE	05 >	•
640	LC4 ADVENTURE	06 >	•
640	LC4 ENDURO	03 > 05	•
640	LC4 ENDURO	06 >	•
640	LC4 RALLY DAKAR	97 >	•
640	LC4 SUPERMOTO	00 > 02	•
640	LC4 SUPERMOTO	03 > 04	•
640	LC4 SUPERMOTO	05 >	•
660	LC4 RALLY	99 > 99	•
660	LC4 RALLY	00 > 02	•
660	LC4 RALLY DAKAR	97 >	•
660	RALLYE FACTORY REPLICAS	03 >	•
660	SM FACTORY	02 >	•
660	SM FACTORY REPLICAS	03 >	•
660	SMC	03 > 03	•
660	SMC	06 >	•

660	SMS	07 >	•
690	DUKE	08 > 11	•
690	DUKE	15 >	•
690	DUKE ABS	12 >	•
690	DUKE R	10 > 11	•
690	DUKE R	14 >	•
690	LC4 690 ENDURO	08 >	•
690	LC4 690 ENDURO	09 >	•
690	LC4 690 ENDURO R	09 >	•
690	SM PRESTIGE	07 >	•
690	SMC	08 >	•
690	SMC R	14 >	•
690	SUPERMOTO	07 >	•
950	DUKE	03 >	•
950	LC8 RALLYE	02 >	•
990	SUPER DUKE	05 > 05	•
990	SUPER DUKE	06 >	•
990	SUPERDUKE R	07 >	•
990	SUPERDUKE R	09 >	•

### MAICO

250	CROSS	99 >	•
250	ENDURO	99 >	•
500	CROSS	99 >	•
500	ENDURO	99 >	•
500	SUPERMOTARD	99 >	•

### ROYAL ENFIELD

535	CONTINENTAL GT	14 >	•
-----	----------------	------	---

### SWM

600	SUPERDUAL	15 >	•
-----	-----------	------	---

### SYM

400	MAXSYM	11 >	•
-----	--------	------	---

### TM

80	CROSS	96 >	•
125	125	96 > 00	•
125	CROSS	91 >	•
125	ENDURO	91 >	•
250	E	95 > 00	•
250	E 4-STROKE	00 >	•
300	300	98 > 00	•
320	320	96 >	•
400	4T	00 > 00	•
530	SMM BLACK DREAM	04 >	•

### TRIUMPH

675	DAYTONA R	13 >	•
-----	-----------	------	---

675	DAYTONA R TRIPLE	13 >	•
675	DAYTONA TRIPLE	13 >	•
675	STREET TRIPLE RX	15 >	•

### VERTEMATI

500	CROSS	02 >	•
501	ENDURO	02 >	•
501	SUPERMOTARD	02 >	•

### VOR

400	CROSS	00 > 01	•
400	EN	02 >	•
400	MX	02 >	•
400	SM	02 >	•
450	EN	02 >	•
450	MX	02 >	•
450	SM	02 >	•
500	CROSS 495	99 >	•
500	ENDURO 492	99 >	•
500	SUPERMOTARD (492)	00 > 01	•
530	EN	02 >	•
530	MX	02 >	•
530	SM	02 >	•

### YAMAHA

125	WR R, XY	09 >	•
125	YBR	06 > 07	•
600	TT 600	97 >	•
600	TT 600 R	97 >	•
660	MT-03	06 >	•
660	XT R	04 > 13	•
660	XT X	04 >	•
660	XTZ TENERE' ABS	11 >	•
660	XTZ TENERE'	08 > 13	•

### ZERO

2.8	ZF FX	14 > 14	•
2.8	ZF FX	15 >	•
5.7	ZF FX	14 > 14	•
5.7	ZF FX	15 > 15	•
8.5	ZF DS	14 > 14	•
8.5	ZF S	14 > 14	•
9.4	ZF DS	15 >	•
9.4	ZF S	15 >	•
11.4	ZF DS	14 > 14	•
11.4	ZF S	14 > 14	•
11.4	ZF SR	14 > 14	•
12.5	ZF DS	15 >	•
12.5	ZF S	15 >	•
12.5	ZF SR	15 >	•





<b>07BB03.06</b>	108.5 x 40.1 x 7.6
<b>07BB03.35</b>	“ “ “
<b>GENUINE</b>	
<b>07BB03.3A</b>	“ “ “
<b>GENUINE</b>	
<b>07BB03.59</b>	“ “ “
<b>GENUINE</b>	
<b>07BB03.90</b>	“ “ “
<b>GENUINE</b>	
<b>07BB03.SA</b>	“ “ “
<b>07BB03.SP</b>	“ “ “

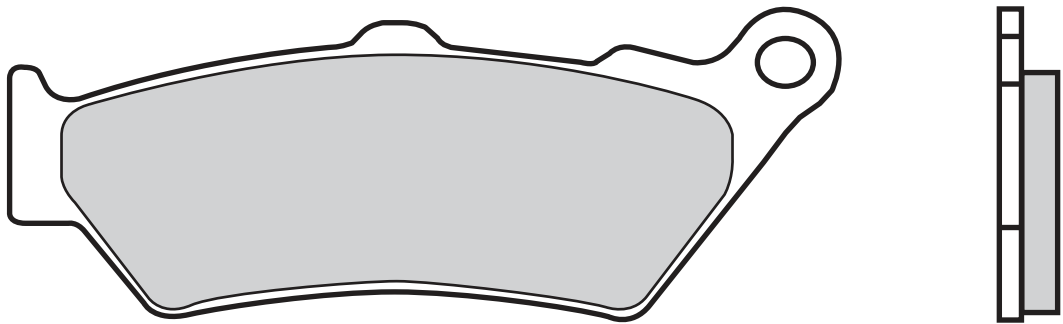

### APRILIA

650 MOTÒ	95 >	•
650 PEGASO	97 > 03	•
650 PEGASO	04 >	•
650 PEGASO I.E.	01 >	•
650 PEGASO TRAIL	06 >	•
650 STARCK	96 >	•
1000 ETV CAPO NORD	01 > 03	•
1000 ETV CAPO NORD ABS	04 >	•
1000 ETV CAPO NORD RALLY RAID	04 >	•

### BIMOTA

1100 DBX	13 >	•
----------	------	---

### BMW

650 F 650 CS	02 > 06	•
650 F 650 GS	01 >	•
650 F 650 GS ABS	00 > 07	•
650 F 650 GS DAKAR	01 > 07	•
650 F 650 GS RALLY	01 >	•
650 F 650 ST	93 > 00	•
650 G 650 GS	09 >	•
650 G 650 XCHALLENGE	07 >	•
650 G 650 XCOUNTRY	07 >	•
650 GS 650 SERTA0	12 >	•
700 F 700 GS	13 >	•
800 F 650 GS	08 >	•

800 F 700 GS	16 >	•
800 F 800 GS	08 > 15	•
800 F 800 GS	16 >	•
800 F 800 GS ADVENTURE	14 >	•
1200 HP2 ENDURO	06 >	•
1200 R 1200 GS	13 >	•
1200 R 1200 GS ADVENTURE	14 >	•
1200 R 1200 R	15 >	•
1200 R 1200 RS	15 >	•
1200 R 1200 RT	14 >	•
1600 K 1600 GT	11 >	•
1600 K 1600 GTL	11 >	•

### DUCATI

400 SCRAMBLER	15 >	•
400 SCRAMBLER SIXTY2	16 >	•
1000 GT 1000	07 >	•
1000 GT 1000 TOURING	09 >	•
1000 PAUL SMART 1000 L.E.	05 >	•
1000 SPORT 1000	05 > 06	•
1000 SPORT 1000 (BIPOSTO)	07 >	•
1000 SPORT 1000 (MONOPOSTO)	07 >	•
1000 SPORT 1000 S	07 >	•
1000 SPORT BIPOSTO	07 >	•
1200 DIAVEL	11 >	•
1200 DIAVEL CARBON	14 >	•
1200 DIAVEL DARK	14 >	•
1200 DIAVEL STRADA	13 >	•

### HARLEY DAVIDSON

750 STREET DARK CUSTOM	16 >	•
------------------------	------	---

### HONDA

500 CB	97 >	•
500 CB S	98 >	•
650 NTV DEAUVILLE	98 > 00	•
650 NTV DEAUVILLE	01 > 02	•
650 NX DOMINATOR	97 > 99	•
650 VIGOR FX	99 > 02	•

### HUSQVARNA

650 TR STRADA	13 >	•
650 TR TERRA	13 >	•

### KTM

450 RALLY	11 >	•
ADVENTURE		
640 TRAVELLER'S EDITION	07 >	•
640 LC4 ADVENTURE	05 >	•
640 LC4 ADVENTURE	06 >	•
690 LC4 690 ENDURO	08 >	•
690 LC4 690 ENDURO	09 >	•
690 LC4 690 ENDURO R	09 >	•
950 LC8 ADVENTURE	03 >	•
950 LC8 ADVENTURE S	03 >	•
950 SUPER ENDURO	07 >	•
950 SUPERENDURO R	06 >	•



990	LC8 ADVENTURE	06 >	•
990	LC8 ADVENTURE R	10 > 12	•
990	LC8 ADVENTURE S	06 >	•
990	LC8 ADVENTURE S / ABS	06 >	•

### MOTO GUZZI

940	BELLAGIO	07 >	•
1100	CALIFORNIA ALUMINIUM	03 >	•
1100	CALIFORNIA CLASSIC	06 >	•
1100	CALIFORNIA EV	01 > 02	•
1100	CALIFORNIA EV	03 >	•
1100	CALIFORNIA EV SPORT	01 > 02	•
1100	CALIFORNIA EV TOURING	97 > 00	•
1100	CALIFORNIA EV TOURING	03 >	•
1100	CALIFORNIA EV TOURING	04 >	•
1100	CALIFORNIA EV TOURING	06 >	•
1100	CALIFORNIA JACKAL	99 > 01	•
1100	CALIFORNIA JACKAL BASIC	00 >	•
1100	CALIFORNIA JACKAL BASIC	01 >	•
1100	CALIFORNIA METAL	02 >	•
1100	CALIFORNIA SPECIAL	99 > 00	•
1100	CALIFORNIA SPECIAL	01 >	•

1100	CALIFORNIA SPECIAL ALUMINIUM	02 >	•
1100	CALIFORNIA SPECIAL SPORT	02 >	•
1100	CALIFORNIA STONE	01 > 05	•
1100	CALIFORNIA STONE	02 >	•
1100	CALIFORNIA TITANIUM	03 >	•
1100	CALIFORNIA TOURING	06 >	•
1100	CALIFORNIA VINTAGE	07 >	•
1100	QUOTA ES	99 > 01	•
1400	CALIFORNIA CUSTOM	13 >	•
1400	CALIFORNIA TOURING	13 >	•

### MOTO MORINI

1200	GRANPASSO	08 >	•
1200	SCRAMBLER	09 >	•

### ROYAL ENFIELD

535	CONTINENTAL GT	14 >	•
-----	----------------	------	---

### TM

125	ENDURO	05 >	•
125	MX	06 >	•
250	ENDURO	05 >	•
250	F	05 >	•
250	F ENDURO	05 >	•
250	MX	06 >	•
300	MX	05 >	•

### TRIUMPH

1500	THUNDERBIRD	09 >	•
1600	THUNDERBIRD	09 >	•
1700	THUNDERBIRD STORM	11 >	•
2300	ROCKET III	04 >	•
2300	ROCKET III	09 >	•
2300	ROCKET III ABS	09 >	•
2300	ROCKET III CLASSIC	07 >	•
2300	ROCKET III CLASSIC	09 >	•
2300	ROCKET III ROADSTER	11 >	•
2300	ROCKET III TOURING	09 >	•
2300	ROCKET III TOURING ABS	09 >	•
2300	ROCKET X	15 >	•

### YAMAHA

125	DT X SUPERMOTARD	05 >	•
660	XT R	04 > 13	•

### ZERO

9.4	ZF DS	15 >	•
9.4	ZF S	15 >	•
12.5	ZF DS	15 >	•
12.5	ZF S	15 >	•
12.5	ZF SR	15 >	•



<b>07BB04.35</b> GENUINE	94 x 36.2 x 7.6
<b>07BB04.83</b> GENUINE	“ “ “
<b>07BB04.95</b> GENUINE	94 x 36.2 x 7.6
<b>07BB04.SA</b>	“ “ x 8
<b>07BB04.SP</b>	“ “ “
<b>07BB04.SD</b>	“ “ “
<b>07BB04.SX</b>	“ “ “
<b>07BB04.TT</b>	“ “ “

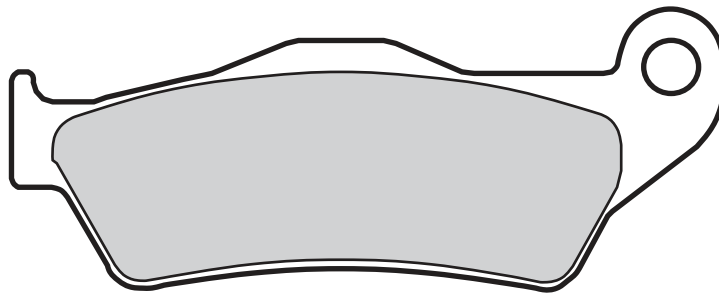

### ALFER

125 VRE - 4 STROKE	00 >	•
250 VR CROSS	99 >	•
250 VR ENDURO	99 >	•
250 VR NO LIMIT	99 >	•
250 VR SUPERMOTARD	99 >	•

### APRILIA

125 MX supermotard	04 >	•
125 MX supermoto	07 >	•
125 RX	96 >	•
125 RX ENDURO	08 >	•
125 RX SUPERMOTARD	08 >	•
125 SX	08 >	•
650 PEGASO	96 > 96	•
850 SRV	12 >	•
1000 RST FUTURA	01 > 04	•

### BENELLI

449 BX CROSS	07 >	•
505 ENDURO	08 >	•

### BIMOTA

1100 DBX	13 >	•
----------	------	---

### BMW

450 ENDURO	08 >	•
450 G 450 X	09 >	•
1000 S 1000 XR	15 >	•



1170 R NINE T SCRAMBLER	16 >	•
1200 HP2 ENDURO	06 >	•
1200 HP2 SPORT	08 >	•
1200 K 1200 GT	08 >	•
1200 K 1200 GT ABS	08 >	•
1200 R 1200 R DARK WHITE	14 >	•
1200 R NINE T	14 >	•

### CAGIVA

900 ELEFANT	93 >	• •
-------------	------	-----

### CCM

450 ENDURO	08 >	•
450 MX	08 >	•
600 RS	01 >	•
600 SPORT	99 >	•
600 SUPERMOTO	99 >	•
644 DS	02 >	•
644 R30	02 >	•

### DUCATI

620 MULTISTRADA 620 (BIDISCO)	05 >	•
695 MONSTER 695	06 >	•
803 MONSTER S2 R	05 >	•
803 MONSTER S2 R DARK	05 >	•
1200 MULTISTRADA	15 >	•
1200 MULTISTRADA ENDURO	16 >	•
1200 MULTISTRADA S	15 >	•



1200 MULTISTRADA S D-AIR	15 >	•
1200 MULTISTRADA S PIKES PEAK	15 >	•
1200 MULTISTRADA TOURING ABS	15 > 16	•
1200 MULTISTRADA TOURING S ABS	15 > 16	•

### GAS GAS

50 WILD HP	04 >	• •
125 EC	97 > 99	•
200 EC	99 > 99	•
200 WILD HP	08 >	• •
240 WILD HP	04 >	• •
250 EC	97 > 99	•
250 MC	97 > 99	•
250 WILD HP	08 >	• •
300 EC	99 > 99	•
300 WILD HP	03 >	• •
450 WILD HP	03 >	• •
515 WILD HP	09 >	• •

### HARLEY DAVIDSON

750 STREET DARK CUSTOM	16 >	•
------------------------	------	---

### HIGHLAND

450 MX	06 >	•
950 V2	99 >	•



## HONDA

650 SLR	97 >	•
---------	------	---

## HUSABERG

ALL MODELS	93 >	•
125 TE	13 >	•
250 FE	13 >	•
250 TE	11 >	•
300 TE	11 >	•
350 FE	13 >	•
390 FE	10 >	•
400 FC	99 >	•
400 FE	99 >	•
450 FC	03 >	•
450 FC (CROSS)	05 >	•
450 FE	09 >	•
450 FE (ENDURO)	05 >	•
450 FE E	04 >	•
450 FX	03 >	•
470 FC	01 >	•
470 FX	01 >	•
501 FE	13 >	•
550 FC	01 >	•
550 FC (CROSS)	05 >	•
550 FE (ENDURO)	05 >	•
550 FE E	04 >	•
570 FE	09 >	•
600 FC	99 >	•
600 FE	99 >	•
650 FE (ENDURO)	05 >	•
650 FX	01 >	•

## HUSQVARNA

50 SM	10 >	•
125 CR	95 > 98	•
125 CR	99 > 02	•
125 CR	03 > 04	•
125 CR	05 >	•
125 SM	98 >	•
125 SM S	09 >	•
125 SM S 4T	11 >	•
125 SMS	00 > 01	•
125 SMS	05 >	•
125 TC	14 >	•
125 TE	11 > 12	•
125 TE	14 >	•
125 TE 4T	11 >	•
125 WR	95 > 97	•
125 WR	98 > 02	•
125 WR	03 > 04	•
125 WR	05 > 10	•
125 WR	11 >	•
125 WR E	94 > 98	•
125 WR E	98 > 05	•
125 WR E	06 >	•
250 CR	95 > 98	•
250 CR	99 > 00	•
250 CR	01 > 01	•
250 CR	02 > 04	•
250 CR	05 >	•
250 FC	14 >	•
250 FE	14 >	•
250 TC	02 > 03	•

250 TC	14 >	•
250 TE	03 > 03	•
250 TE	04 >	•
250 TE	14 >	•
250 TE 4T	10 >	•
250 WR	95 > 97	•
250 WR	98 > 00	•
250 WR	01 > 01	•
250 WR	02 >	•
300 TC	14 >	•
300 TE	14 >	•
300 WR	09 >	•
310 TE	10 > 12	•
310 TE 4T	10 >	•
350 FC	14 >	•
350 FE	14 >	•
350 TE	95 >	•
360 WR	95 > 98	•
360 WR	98 > 00	•
360 WR	01 > 01	•
360 WR	02 >	•
400 TE	01 >	•
410 TE	95 > 98	•
410 TE	99 > 00	•
410 TE E	00 > 01	•
449 TC 449	04 >	•
449 TE 449	02 > 05	•
449 TE 449	06 >	•
450 FC	14 >	•
450 FE	14 >	•
450 TC	03 > 03	•
501 FE	14 >	•
510 TC	02 > 04	•
510 TC 511	05 > 10	•
510 TE 511	05 > 05	•
510 TE 511	06 > 10	•
510 TE 511	11 >	•
510 TE CENTENNIAL	04 >	•
510 TE R	04 >	•
570 TC	02 >	•
570 TE	01 > 04	•
610 TC	96 > 97	•
610 TC	98 > 98	•
610 TC	99 > 00	•
610 TE	96 > 97	•
610 TE	98 > 98	•
610 TE	99 > 00	•
610 TE E	98 > 99	•
610 TE E	00 > 01	•
610 TE E	03 > 04	•
610 TE E DUAL PURPOSE	06 >	•
610 TE E LT	99 > 99	•
630 SM	10 >	•
630 TE	10 >	•

## KRAMIT

250 GS	97 >	•
250 MX	97 >	•
250 SM	97 >	•

## KTM

125 EGS	93 > 93	•
125 EGS	94 > 97	•
125 EGS	98 > 98	•

125 EGS	99 >	•
125 EXC	93 > 93	•
125 EXC	94 > 97	•
125 EXC	98 > 98	•
125 EXC	99 > 99	•
125 EXC	00 > 00	•
125 EXC	01 > 03	•
125 EXC	04 >	•
125 EXC SIX DAYS	09 >	•
125 EXE	00 > 01	•
125 GS	92 >	•
125 LC2	96 > 98	•
125 MX	92 >	•
125 SUPERMOTO	00 > 01	•
125 SX	92 > 93	•
125 SX	94 > 97	•
125 SX	98 > 98	•
125 SX	99 > 00	•
125 SX	01 > 03	•
125 SX	04 >	•
125 SXS	01 > 02	•
144 SX	07 > 08	•
150 SX	09 >	•
200 EGS	98 > 98	•
200 EGS	99 >	•
200 EXC	98 > 98	•
200 EXC	99 > 00	•
200 EXC	01 > 03	•
200 EXC	04 >	•
200 MXC	98 >	•
200 MXC	99 > 00	•
200 MXC	01 > 03	•
200 SX	04 >	•
250 EGS	94 > 98	•
250 EGS	99 >	•
250 EXC	94 > 98	•
250 EXC	99 > 00	•
250 EXC	01 > 03	•
250 EXC	04 >	•
250 EXC F	06 >	•
250 EXC F SIX DAYS	09 >	•
250 EXC RACING	03 > 04	•
250 EXC RACING	05 >	•
250 MX	92 >	•
250 MXC	00 > 00	•
250 MXC	01 >	•
250 SX	92 > 93	•
250 SX	94 > 98	•
250 SX	99 > 00	•
250 SX	01 > 02	•
250 SX	03 >	•
250 SX-F	06 >	•
250 SXC	03 >	•
250 SXS	01 >	•
300 EGS	93 > 93	•
300 EGS	94 > 98	•
300 EGS	99 >	•
300 EXC	93 > 03	•
300 EXC	94 > 98	•
300 EXC	99 > 00	•
300 EXC	01 > 03	•
300 EXC	04 >	•
300 EXC SIX DAYS	09 >	•
300 MXC	97 > 98	•
300 MXC	99 > 00	•



300	MXC	01 > 03	•
300	SX	92 > 93	•
300	SX	94 > 05	•
300	SX	06 >	•
350	EXC	94 >	•
350	EXC F	11 >	•
350	EXC F SIX DAYS	11 >	•
350	EXC LC4	93 > 94	•
350	SXF	11 >	•
360	EGS	96 > 97	•
360	EXC	96 > 97	•
360	MXC	97 >	•
360	SX	96 > 97	•
380	EGS	98 >	•
380	EGS	99 >	•
380	EXC	98 >	•
380	EXC	99 >	•
380	EXC	00 >	•
380	EXC	01 > 02	•
380	MXC	98 >	•
380	MXC	99 >	•
380	MXC	00 >	•
380	MXC	01 >	•
380	SX	98 >	•
380	SX	99 > 00	•
380	SX	01 > 02	•
400	EGS	94 > 97	•
400	EXC	94 > 96	•
400	EXC	00 >	•
400	EXC	01 > 02	•
400	EXC RACING	05 >	•
400	LC4	98 > 01	•
400	MXC	02 >	•
400	SUPERMOTO	01 >	•
400	SX	98 >	•
400	SX	99 > 00	•
400	SX	01 > 02	•
400	SXC	97 >	•
440	SX	94 >	•
450	EXC	03 >	•
450	EXC	04 >	•
450	EXC R	05 > 06	•
450	EXC R	07 >	•
450	MXC	03 >	•
450	SX	03 > 03	•
450	SX	04 >	•
450	SX RACING	05 >	•
450	SXF	07 >	•
450	XC-F	08 >	•
500	MX	92 >	•
500	SX	92 > 93	•
505	505 XC-F	09 >	•
505	SX-F	07 >	•
520	EXC	01 > 02	•
520	MXC	01 > 02	•
520	SX	00 > 00	•
520	SX	01 > 02	•
525	EXC	03 > 03	•
525	EXC	04 >	•
525	EXC RACING	05 >	•
525	MXC	03 >	•
525	SX	03 > 03	•
525	SX	04 >	•
525	SX RACING	05 >	•
525	XC DESERT RACING	04 >	•

530	EXC	08 >	•
530	EXC R	09 >	•
540	SXC	99 >	•
540	SXS	01 > 02	•
550	MXC	96 >	•
600	LC4	93 >	•
620	ADVENTURE	97 >	•
620	EGS	94 > 97	•
620	EXC	94 >	•
620	LC4	98 > 99	•
620	LC4 RALLY DAKAR	97 >	•
620	SC	01 >	•
620	SUPERMOTO	01 >	•
620	SX	94 > 97	•
620	SX	98 > 98	•
620	SX	99 >	•
620	SXC	97 >	•
625	SC	02 >	•
625	SUPERMOTO	02 >	•
625	SXC	03 >	•
640	LC4	98 > 04	•
640	LC4	05 >	•
640	LC4 ADVENTURE	98 > 02	•
640	LC4 ADVENTURE	03 > 04	•
640	LC4 ENDURO	03 > 05	•
640	LC4 ENDURO	06 >	•
640	LC4 RALLY DAKAR	97 >	•
640	LC4 SUPERMOTO	00 > 02	•
660	LC4 RALLY	99 > 99	•
660	LC4 RALLY	00 > 02	•
660	LC4 RALLY DAKAR	97 >	•
660	RALLYE FACTORY REPLICA	03 >	•
950	LC8 ADVENTURE	01 > 02	•
950	LC8 ADVENTURE	03 >	•
950	LC8 ADVENTURE S	03 >	•
950	LC8 RALLYE	02 >	•
950	SUPER ENDURO	07 >	•
950	SUPERENDURO R	06 >	•
950	SUPERMOTO	05 >	•
950	SUPERMOTO R	07 >	•
990	LC8 990 SUPERMOTO R	09 >	•
990	LC8 ADVENTURE	06 >	•
990	LC8 ADVENTURE R	10 > 12	•
990	LC8 ADVENTURE S	06 >	•
990	LC8 ADVENTURE S / ABS	06 >	•
990	SUPERMOTO	06 >	•
990	SUPERMOTO	09 >	•
990	SUPERMOTO T	09 >	•
1050	ADVENTURE	15 >	•
1190	ADVENTURE	13 >	•
1290	SUPER ADVENTURE	15 >	•

### MAICO

250	CROSS	99 >	•
250	ENDURO	99 >	•
500	CROSS	99 >	•
500	ENDURO	99 >	•
500	SUPERMOTARD	99 >	•

### MOTO GUZZI

850	BREVA	06 >	•
850	GRISO	06 >	•

940	BELLAGIO	07 >	•
1100	BREVA	05 > 07	•
1100	BREVA ABS	05 > 07	•
1100	GRISO	05 >	•
1100	QUOTA ES	99 > 01	•
1200	BREVA	11 >	•
1200	GRISO 8V	07 >	•
1200	NORGE	06 >	•
1200	NORGE ABS	06 >	•
1200	NORGE GT 8V	08 >	•
1200	SPORT	06 >	•
1200	SPORT 4V	09 > 11	•
1200	SPORT 4V	09 >	•
1200	SPORT 8V	12 >	•
1200	SPORT 8V SE	12 >	•
1200	SPORT ABS	06 >	•
1200	STELVIO	08 > 11	•
1200	STELVIO 8V SE	12 >	•
1200	STELVIO NTX	09 > 11	•

### MOTO MORINI

1200	GRANFERRO	10 >	•
1200	GRANPASSO	08 >	•
1200	SCRAMBLER	09 >	•

### RIEJU

250	MRX MARATHON	10 >	•
450	MRX	08 >	•

### SHERCO

250	2.5 I ENDURO	06 > 11	•
250	I/R	12 >	•
250	SE R	14 >	•
250	SEF	14 >	•
250	SEI-F	14 >	•
250	SX 2.5	09 > 10	•
250	SX 2.5	11 >	•
300	I/R	12 >	•
300	SE 3.0	10 >	•
300	SE 3.0I-F	10 > 11	•
300	SE R	14 >	•
300	SEF	14 >	•
300	SEI-F	13 >	•
450	ENDURO	04 > 04	•
450	ENDURO	05 > 11	•
450	IR	12 >	•
450	SEF	14 >	•
510	5.1 I ENDURO	06 > 11	•
510	IR	12 >	•

### SWM

125	RS R	16 >	•
125	SM R	16 >	•
250	MC S	16 >	•
340	RS S	16 >	•
500	RS R	15 >	•

### TM

80	CROSS	96 >	•
85	85	01 > 12	•
125	125	96 > 00	•
125	125	01 > 04	•
125	ENDURO	01 > 04	•



250 250	01 > 04 •
250 250 4-STROKE	01 > •
250 E	95 > 00 •
250 E	01 > •
250 E 4-STROKE	00 > •
250 E 4-STROKE	01 > 04 •
300 300	98 > 00 •
300 300	01 > •
300 E	01 > 04 •
320 320	96 > •
400 4T	00 > 00 •
400 4T	01 > •
400 E 4 STROKE	01 > •
450 4T	02 > 04 •
450 ENDURO 4 STROKE	02 > 04 •
450 F	05 > •
450 F ENDURO	05 > •

530 4T	01 > 04 •
530 E 4 STROKE	01 > 04 •
530 F	05 > •
530 F ENDURO	05 > •

### VERTEMATI

500 CROSS	02 > •
501 ENDURO	02 > •
501 SUPERMOTARD	02 > •

### VOR

400 CROSS	00 > 01 •
400 EN	02 > •
400 MX	02 > •
450 EN	02 > •
450 MX	02 > •

500 CROSS 495	99 > •
500 ENDURO 492	99 > •
530 EN	02 > •
530 MX	02 > •

### YAMAHA

125 YZF R	08 > 13 •
600 TT	93 > •
600 TT 600	97 > •
600 TT 600 R	97 > •
660 XTZ TENERE' ABS	11 > •
660 XTZ TENERE'	08 > 13 •

### ZERO

2.8 ZF FX	15 > •
5.7 ZF FX	15 > 15 •



**07BB06.06** 119.7 x 51.8 x 7.8

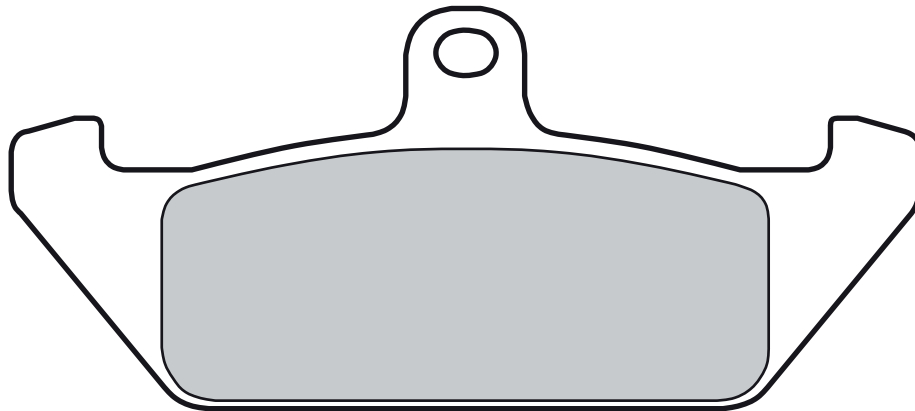

#### APRILIA

350	TUAREG WIND	88 > 89	•
600	TUAREG WIND	88 > 89	•

#### CAGIVA

350	ELEFANT	85 >	•
650	ELEFANT	85 > 87	•
750	ELEFANT BIFARO	90 >	•
750	LUCKY EXPLORER	88 >	•

#### DUCATI

650	INDIANA	86 >	•
750	INDIANA	89 >	•

#### LAVERDA

600	ATLAS	86 >	•
-----	-------	------	---



#### MOTO GUZZI

650	VT 65 TT BAJA	86 >	•
750	NTX	89 > 89	•

#### MOTO MORINI

350	INDIANA	88 >	•
501	EXCALIBUR	86 > 86	• •
501	EXCALIBUR	89 > 89	•
650	INDIANA	88 >	•
750	INDIANA	88 >	•



**07BB07.08** 84.9 x 42.4 x 7.5

55.8 x 37 x 9.8

**07BB07.TT** “ “ “

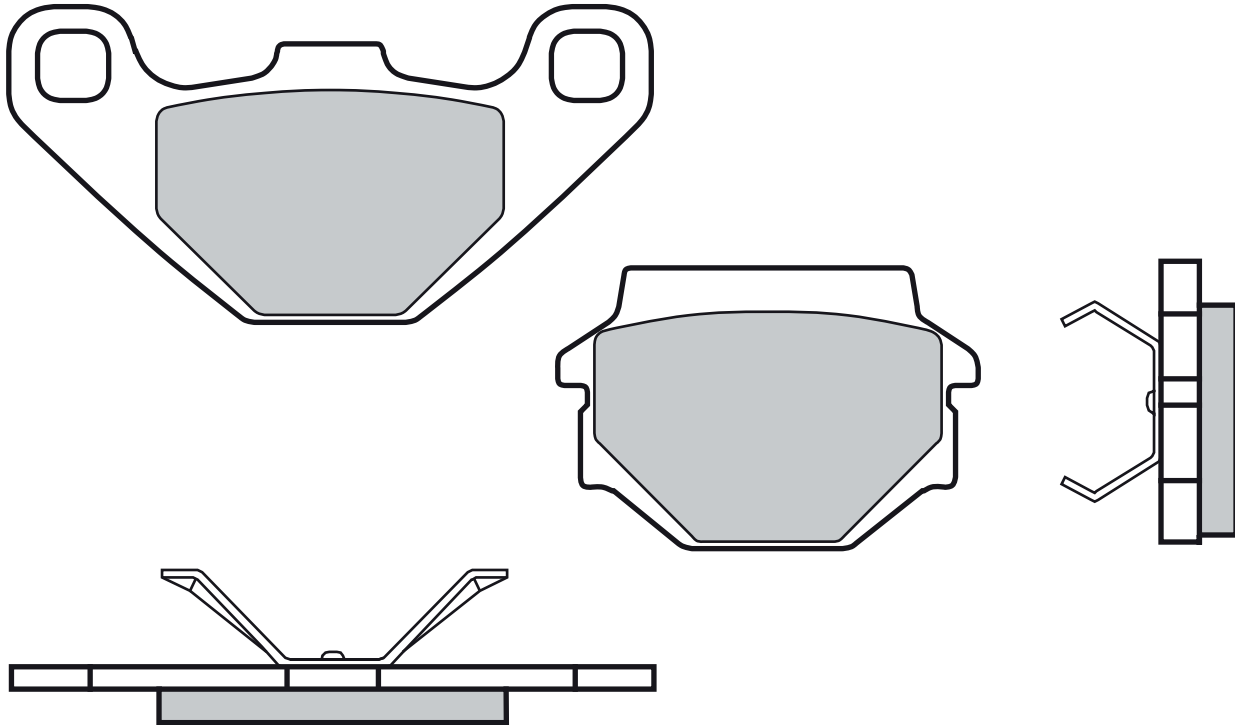

### APRILIA

125 PEGASO	90 > 91	•
125 RX	91 > 91	•
125 RX	96 >	•
125 TUAREG WIND	90 >	•
350 TUAREG WIND	90 >	•
600 TUAREG	88 >	•
600 TUAREG WIND	90 >	•
650 MOTÒ	95 >	•
650 PEGASO	92 > 95	•
650 PEGASO	96 > 96	•
650 PEGASO	97 > 03	•
650 STARCK	96 >	•

### BUELL

1200 RS	93 >	•
---------	------	---

### CAGIVA

125 CROSS	88 >	•
125 W9	96 >	•
125 WMX	89 >	•
250 WMX	89 >	•
500 W16	94 > 98	•
600 W16	94 >	•

### FANTIC MOTOR

50 RAIDER	84 >	•
50 STRADA	83 >	•
125 STRADA	83 >	•

### HUSQVARNA

125 CR	91 > 91	•
125 WR	91 > 91	•
240 WR	91 >	•
250 CR, WR	91 >	•
260 WR	91 >	•
360 TE	95 > 98	•
510 CROSS COUNTRY LC	87 >	•
510 ENDURO LC	87 >	•
510 MOTOCROSS LC	87 >	•
510 TC MOTOCROSS	88 >	•
610 TC CROSS	91 >	•
610 TE	91 > 95	•

### KRAMIT

50 SCRAMBLER	70 >	•
125 ER	89 >	•
250 ER	89 >	•
250 MC	89 >	•
300 ER	89 >	•

### KTM

125 EGS	93 > 93	•
125 EXC	93 > 93	•
125 GS	92 >	•
125 MX	89 > 91	• •
125 MX	92 >	•
125 SX	92 > 93	•
250 MX	89 > 91	• •
250 MX	92 >	•
250 SX	92 > 93	•
300 EGS	93 > 93	•
300 EXC	93 > 03	•
300 SX	92 > 93	•
350 EXC LC4	93 > 94	•
500 MX	89 > 91	• •
500 MX	92 >	•
500 SX	92 > 93	•
600 LC4	93 >	•
600 MX	91 >	• •

### TM

400 CROSS	00 >	•
-----------	------	---

### YAMAHA

125 TDR ITALIA	90 >	•
----------------	------	---





**07BB09.07** 99.9 x 46.8 x 8.5

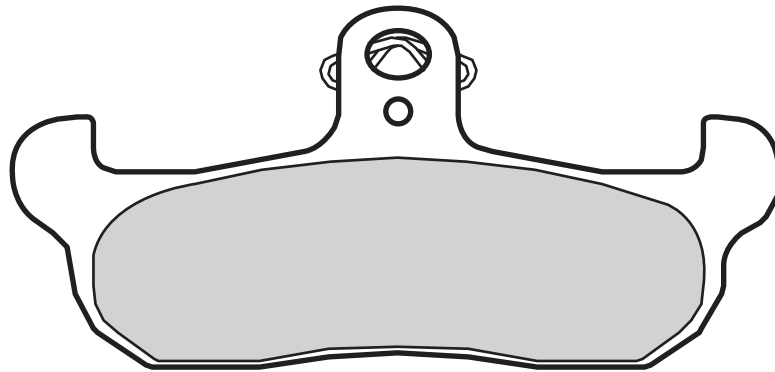

### APRILIA

125 AF1	86 >	•
125 RX	90 > 90	•
125 TUAREG RALLY	89 > 89	•
125 TUAREG WIND	88 > 88	•
350 RALLY	86 >	•

### CAGIVA

50 WMX	89 >	•
125 CROSS	88 >	•
125 CRUISER	87 >	•
125 LUCKY EXPLORER	88 >	•
125 WMX	87 > 88	•
125 WMX	89 >	•
250 CROSS	86 >	•
250 WMX	87 > 88	•
250 WMX	89 >	•

### FRIGERIO PUCH

125 F7	89 >	•
250 REPLAY	89 >	•

### GILERA

125 RC TOP RALLY	89 >	•
600 RC	88 >	•

### HM

50 CRE	98 > 05	•
--------	---------	---

### HONDA

50 CRE	93 >	•
--------	------	---

### HUSABERG

ALL MODELS	89 > 92	•
350 350	91 >	•
500 500	91 >	•
501 ENDURO	70 >	•
600 ENDURO	70 >	•

### HUSQVARNA

125 CR	91 > 91	•
125 WR	91 > 91	•
240 WR	87 > 90	•
240 WR	91 >	•
250 CR, WR	91 >	•
250 WR	87 > 91	•
250 XC	87 >	•
260 WR	91 >	•
360 TE	95 > 98	•
400 WR	87 >	•
430 CR	87 >	•
430 WR	87 >	•
430 XC	87 >	•
500 XC	87 >	•

510 CROSS COUNTRY LC	87 >	•
510 ENDURO LC	87 >	•
510 MOTOCROSS LC	87 >	•
510 TC MOTOCROSS	88 >	•
510 TE ENDURO	88 >	•
510 TX CROSS COUNTRY	88 >	•
610 TC CROSS	91 >	•
610 TE	91 > 95	•

### KRAMIT

125 ER	89 >	•
250 ER	89 >	•
250 MC	89 >	•
300 ER	89 >	•

### MOTO MORINI

400 DART	89 > 89	•
----------	---------	---

### TM

80 GS	87 >	•
80 MC	87 >	•
125 GS	87 >	•
400 CROSS	00 >	•

### YAMAHA

125 DT TENERE	89 >	•
125 TDR ITALIA	90 >	•



**07BB10.SC** 77.4 x 40.7 x 8.3

**07BB10.RC** “ “ “

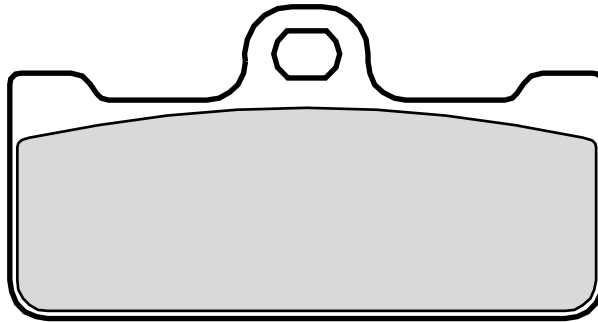

**APRILIA**

450	SXV VAN DEN BOSCH REPLICA	08 >	•
550	SXV VAN DEN BOSCH REPLICA	08 >	•



**07BB12.05** 35.7 x 45.4 x 6  
**07BB12.TT** “ “ “

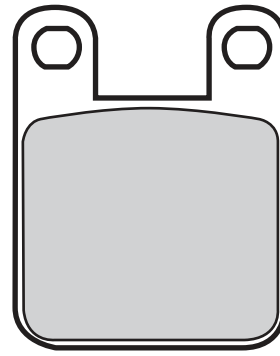

### ALFER

80 MC 87 > •

### APRILIA

240 TX 86 > •  
 250 AF1 REPLICA 90 > •  
 280 CLIMBER 92 > • •  
 311 TX 86 > • •  
 312 TX 88 > 89 •  
 312 TXR 88 > 89 •

### BETA

50 REV 00 > • •  
 50 RR ENDURO 99 > 03 •  
 50 RR STANDARD 99 > •  
 50 RR SUPERMOTARD 99 > 03 •  
 50 RR SUPERMOTARD 04 > 07 • •  
 50 ST 97 > • •  
 50 SUPER TRIAL 92 > •  
 50 TECHNO 96 > • •  
 50 TEMPO 92 > 96 •  
 80 EVO JUNIOR 10 > • •  
 80 REV 06 > • •  
 125 ALP 99 > • •  
 125 TR 97 > •  
 125 TR34 88 > 90 • •  
 125 TR35 88 > 90 • •  
 125 TRIAL 97 > •  
 200 ALP 00 > • •  
 240 ALP 92 > 95 •  
 240 ALP 96 > •  
 240 SUPER TRIAL 92 > •  
 250 ALP 92 > 96 •  
 250 ALP 97 > • •  
 250 EIKON 99 > • •  
 250 TECHNO 96 > • •  
 250 ZERO 91 > •  
 260 ALP 96 > •  
 260 TR34 89 > 92 •  
 260 TR35 89 > 92 •  
 260 ZERO 91 > •

### BULTACO

50 ASTRO 01 > •  
 50 LOBITO 99 > •



### CAGIVA

50 CORSA 98 > •  
 50 MITO 99 > •

### DERBI

50 BLACK DEVIL 04 > •  
 50 DRD PRO R 06 > •  
 50 DRD RACING R 05 > •  
 DRD RACING R LIMITED EDITION 05 > •  
 50 DRD RACING SM 05 > •  
 DRD RACING SM LIMITED EDITION 05 > •  
 50 FDX 89 > •  
 50 FENIX 94 > • •  
 50 GP 01 > •  
 50 GPR 98 > 08 •  
 50 GPR 09 > •  
 50 GPR NUDE 04 > •  
 50 GPR RACING 04 > •  
 50 GPX1 06 > •  
 50 SAVANNAH 91 > •  
 50 SENDA DRD EVO SM 09 > •  
 50 SENDA DRD PRO R/SM 09 > •  
 SENDA DRD RACING R/SM 09 > •  
 50 SENDA R 94 > 99 • •  
 50 SENDA R 03 > 04 •  
 50 SENDA SM 99 > 02 • •  
 50 SENDA SM DRD 03 > 04 • •  
 SENDA SM DRD BLACK ED. 03 > •  
 50 SENDA X-RACE R/SM 09 > • •  
 50 SENDA X-TREME R/SM 09 > • •  
 50 X-RACE R 05 > • •  
 50 X-TREME R 05 > • •  
 75 GPR 89 > •  
 80 GPR CUP 04 > •  
 125 BOULEVARD S 09 > •  
 125 CROSS CITY 09 > •  
 125 GP1 05 > •  
 125 GPR 05 > •  
 125 GPR NUDE 05 > •  
 125 GPR RACING 09 > •  
 125 SENDA 4-STROKE 04 > •  
 125 SENDA BAJA R/SM 09 > •  
 125 SENDA R 4-STROKE 05 > •



125 SENDA X-TREME SM 04 > •  
 125 TERRA 07 > 07 • •

### FANTIC MOTOR

50 CLUBMANN 94 > •  
 50 TRIAL 89 > •  
 250 K-ROO 91 > •  
 250 TRIAL 91 > •  
 305 TRIAL 88 > •  
 307 TRIAL 91 > • •

### GARELLI

50 CICLONE LC, SM 86 > •  
 50 GSP 09 > •  
 323 TRIAL 86 > •

### GAS GAS

50 TXT BOY 04 > • •  
 125 DELTA 91 > •  
 125 PAMPERA 96 > 03 • •  
 200 PAMPERA 99 > • •  
 200 TX 97 > • •  
 250 PAMPERA 96 > 99 • •  
 250 TRIAL 89 > • •  
 270 TX 97 > • •  
 320 TX 97 > • •  
 370 PAMPERA 96 > • •

### GILERA

50 HAK 99 > • •  
 50 RCR 04 > • •  
 50 SMT 04 > • •  
 50 SUPERMOTARD 01 > • •  
 50 ZULU 01 > • •  
 125 GSM 00 > • •  
 125 SC 06 > •

### HRD

50 SONIC 00 > 02 •  
 50 SONIC TRIAL 00 > 02 •  
 125 SUPERMOTARD 00 > •  
 125 TRIAL 00 > •

### HUSQVARNA

50 HUSKY BOY 01 > •  
 50 RACING 98 > •



50	SM	02 > 09	•
50	WR	02 >	•
50	WRS	98 >	•

**KTM**

50	SX	99 >	•
65	SX	00 > 01	•

**MACAL**

50	TROPHY	99 >	•
----	--------	------	---

**MALAGUTI**

50	DRAKON	05 >	•
50	NKD	04 >	•
50	NKD DRAGON	06 >	•
50	XSM	03 >	•

**MONTESA**

125	COTA	88 >	• •
260	EVASION	92 >	•
304	COTA	88 >	• •
307	COTA	89 >	• •
307	COTA TRIAL	88 >	• •
309	COTA	89 >	•
310	COTA	89 >	•
311	COTA TRIAL	92 >	•
315	COTA R	97 >	• •
335	COTA	87 > 91	• •
360	ENDURO	85 >	•

**MORBIDELLI MBA**

125	JR	76 >	• •
-----	----	------	-----

**PEUGEOT**

50	BUXY R (AJP CALIPER)	93 > 97	•
50	JET C-TECH	05 > 08	•
50	JET C-TECH	09 >	• •
50	LOOXOR	02 > 05	•
50	XP6 ENDURO	06 >	• •
50	XP6 SUPERMOTARD	06 >	• •

50	XP6 TRIAL	04 > 05	• •
50	XPS6 ENDURO	02 >	• •
50	XPS6 SUPERMOTARD	04 > 05	•
50	XR6	02 > 07	•
50	XR7	08 >	•
150	LOOXOR	02 > 05	•

**PUCH**

50	TZX	92 >	•
75	COBRA	85 >	•

**RIEJU**

50	DRAC	97 >	• •
50	EVOLUTION RS1	96 > 00	• •
50	FD4 SUPER MARATHON	85 >	•
50	MATRIX	03 >	•
50	MRX	02 > 04	• •
50	MRX PRO	05 >	•
50	MX (AJP CALIPER)	02 >	• •
50	NKD	04 >	•
50	RACING	01 >	•
50	RR SUPERMOTARD	96 >	• •
50	RRX SPIKE	08 >	• •
50	RS1	92 > 00	• •
50	RS1	01 >	•
50	RS1 CASTROL	01 >	•
50	RS2 MATRIX	03 >	•
50	RS3 PRO	12 >	•
50	SMX	02 >	•
50	SMX PRO	08 >	•
50	SPIKE	02 >	•
50	SPIKE (AJP CALIPER)	02 >	•
50	TANGO	10 >	•
80	CROSS, ENDURO	87 >	• •
80	RST	91 >	• •
125	MRX	03 >	•
125	MRX (AJP CALIPER)	03 >	• •
125	RR	97 >	• •
125	RS3	10 >	•
125	SMX	03 >	•
125	SMX (AJP CALIPER)	03 >	• •
125	TANGO	06 > 07	•

125	TANGO	08 >	•
125	TANGO PRO	08 >	•
250	TANGO	08 >	•

**SCORPA**

115	TY-S F TRIAL	06 >	•
-----	--------------	------	---

**SHERCO**

50	ENDURO	02 >	•
50	ENDURO	07 >	•
50	SM	02 >	•
50	SUPERMOTARD	07 >	•
80	80	01 >	• •
125	125	01 > 01	• •
125	125	02 >	•
125	CITY CORP 4T ENDURO	03 >	•
125	CITY CORP 4T SM	03 >	•
125	ST	01 > 05	• •
200	200	01 >	• •
250	250	99 > 00	• •

**SIMSON**

125	SM	01 >	•
125	STAR	99 >	•

**SUZUKI**

50	DR BIG	89 >	•
50	RMX	00 >	• •
50	SMX SUPERMOTARD	00 >	• •

**TGB**

50	CAPPUCCIO	09 >	•
----	-----------	------	---

**YAMAHA**

50	DT R	04 >	•
50	TZR	03 >	•
125	XT R	05 >	• •
125	XT X SUPERMOTARD	05 >	•
250	TY R	91 > 92	•
250	TY Z	93 >	• •



**07BB13.05** 35.8 x 51.6 x 5.9

**07BB13.24** “ “ “  
GENUINE

**07BB13.SD** “ “ “

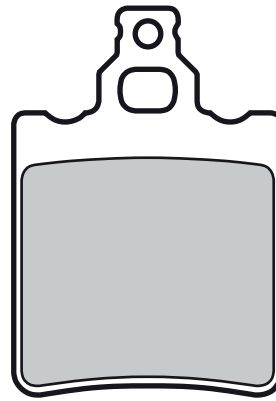

### APRILIA

50	AF-1	86 >	•
50	AF-1 EUROPA	90 >	•
50	AF-1 FUTURA	90 >	•
50	ET	85 >	•
50	ET TUAREG	86 >	•
50	MX	03 >	•
50	PEGASO	70 >	•
50	RS	93 > 95	•
50	RS	96 > 99	•
50	RS EXTREMA	00 >	•
50	RS REPLICIA	00 >	•
50	RS REPLICIA	03 > 05	•
50	RX	90 > 91	•
50	RX	92 > 05	•
50	RX RACING	04 > 07	•
50	TUAREG	85 > 85	•
50	TUAREG	86 >	•
50	TUAREG RALLY	90 >	•
125	TUAREG WIND	88 > 88	•
240	CLIMBER	89 > 90	•
275	CLIMBER	89 > 90	•

### BETA

350	4.0 MOTARD	04 >	•
350	ALP 4.0	04 > 05	•

### CAGIVA

50	BLUES	89 >	•
50	LUCKY EXPLORER	88 >	•
50	W4	92 >	•
80	COCIS	91 >	•
80	W4	92 >	•
125	ALETTA ORO	85 > 86	• •
125	ALETTA ORO	87 >	• •
125	ALETTA ROSSA	83 >	•
125	DAKAR	89 > 90	•
125	E2	86 >	•

125	ELECTRA	83 > 86	•
125	ELECTRA	87 >	•
125	ELEFANT	83 > 86	•
125	LUCKY EXPLORER	88 >	•
125	N 90	90 >	•
125	SPORT	85 >	• •
125	SST	81 >	•
125	SXT	81 >	•
125	TAMANACO	89 >	•
125	W8	92 > 98	•
200	ALETTA ELECTRA	83 >	•
200	CROSS	83 >	•

### FANTIC MOTOR

50	CABALLERO RC	90 >	•
50	CABALLERO RS	90 >	•
50	K-ROO	91 >	•
50	KOALA	88 > 95	• •
50	OASIS	88 > 89	• •
50	OASIS	90 >	•
75	OASIS	89 >	•
125	K-ROO	91 >	•
125	RAIDER LC	83 > 84	•
250	K-ROO	91 >	•
250	TRIAL	91 >	•
305	TRIAL	88 >	•

### FRIGERIO PUCH

125	CROSS	84 > 85	•
125	REPLAY	89 >	•

### GARELLI

125	SPORT	84 > 85	•
125	STRADA	84 > 85	•
125	STRADA GTA	83 > 85	• •
125	TIGER XLE	86 >	•

### GILERA

125	X1	89 > 89	•
250	NGR	85 >	•

### HRD

125	SILVER HORSE	85 >	• •
-----	--------------	------	-----

### LAVERDA

125	125	84 >	•
125	CUSTOM	86 >	• •
125	GS LESMO	86 >	• •
125	LB (CU/SP)	84 >	•
125	LB SPORT	84 >	•
125	LB STRADA	85 >	•
125	LESMO	86 >	• •
125	LS STRADA	85 >	•
125	NAVARRO	90 >	• •
125	TOLEDO	90 >	• •
150	FORMULA	86 >	•

### MALAGUTI

50	DUNE ES	89 >	• •
50	EVOLUTION	91 >	•
50	MDX	86 >	•
50	RST SPORT	88 > 96	• •
50	XTM	03 >	• •

### MALANCA

80	GTI	70 >	• •
125	GTI	80 >	• •
125	MARK ENDURO	85 >	•
125	OB ONE M6	85 >	• •
125	SPORT	78 >	• •

### ZÜNDAPP

80	KS SUPER	80 > 81	•
80	KS SUPER	82 > 82	•



**07BB14.08** 55.6 x 53.8 x 8.9

**07BB14.18** “ “ “  
GENUINE

**07BB14.SP** “ “ “

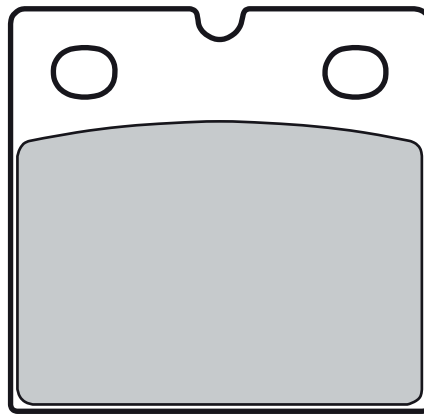

### BENELLI

350	354 TURISMO, SPORT	83 >	•
500	504 SPORT	76 >	•
650	654	83 >	•
650	654 SPORT	83 >	•
750	SEI	75 >	•
900	SEI	78 >	•

### BIMOTA

1000	DB 1	87 > 90	•
1200	YB 5 FS	87 >	•

### BMW

450	R 45	81 >	•
650	R 65	81 >	•
650	R 65 GS	87 >	•
650	R 65 LS	82 >	•
650	R 65/1	86 >	•
750	K 75	84 >	•
750	K 75 ABS (SPECIAL CALIPER)	91 >	•
750	K 75 C	84 >	•
750	K 75 RT	91 >	•
750	K 75 S	83 >	•
750	K 75T	84 >	•
800	R 80	81 >	•
800	R 80 GS	81 > 87	•
800	R 80 R	92 > 92	•
800	R 80 RT	83 > 84	•
800	R 80/7	79 > 81	•
1000	K 1	89 >	•
1000	K 100	83 >	•
1000	K 100 ABS (SPECIAL CALIPER)	91 >	•
1000	K 100 LT	87 > 91	•
1000	K 100 LT	92 >	•
1000	K 100 LT ABS	90 > 91	•
1000	K 100 RS	83 >	•
1000	K 100 RS 16V	90 >	•
1000	K 100 RT	84 >	•
1000	R 100 CS	81 > 83	•
1000	R 100 CS	84 >	•
1000	R 100 R	91 > 91	•
1000	R 100 RS	76 > 80	•
1000	R 100 RS	81 > 83	•

1000	R 100 RS	84 > 92	•
1000	R 100 RS	93 >	•
1000	R 100 RT	79 > 80	•
1000	R 100 RT	81 > 83	•
1000	R 100 RT	84 > 90	•
1000	R 100 S	78 > 80	•
1000	R 100 T	79 >	•
1100	K 1100 LT (no ABS)	92 >	•
1100	K 1100 RS	93 >	•
1100	R 1100 RS	93 >	•
1100	R 1100 RS	94 >	•
1200	K 1200 GT	02 > 07	•
1200	K 1200 GT ABS	02 > 07	•
1200	K 1200 RS	97 > 00	•
1200	K 1200 RS	01 >	•

### DUCATI

600	PANTAH	81 >	•
650	SL	84 >	•
750	LAGUNA SECA	87 >	•
750	PASO	87 > 88	•
750	SANTAMONICA	87 >	•
750	SPORT	74 > 76	•
750	SPORT	88 > 89	•
900	MIKE HAILWOOD REPLICA	85 >	•
900	REPLICA	85 >	•
900	S2	82 >	•
900	S2 DESMO	85 >	•
900	SUPERSPORT 900	81 >	•
906	PASO	89 >	•
906	SANTAMONICA	87 >	•
1000	MIKE HAILWOOD REPLICA	85 >	•
1000	R1	84 >	•
1000	S2 DESMO	85 >	•

### HOREX

125	IMPERATOR	96 >	•
125	REGENT	96 >	•
560	560 E	86 >	•
600	COLUMBUS	87 >	•

### HRD

600	600 (HOREX)	85 >	•
-----	-------------	------	---

### INDIAN

1700	CHIEF BLACKHAWK	11 > 13	•
1700	CHIEF BOMBER	10 > 13	•
1700	CHIEF CLASSIC	10 > 13	•
1700	CHIEF DARK HORSE	10 > 13	•
1700	CHIEF DELUXE	09 > 13	•
1700	CHIEF ROADMASTER	09 > 13	•
1700	CHIEF STANDAR	09 > 13	•
1700	CHIEF VINTAGE	09 > 13	•

### LAVERDA

650	SFC	86 >	•
650	V-SIX	93 >	•
750	SF3	74 > 78	•
1000	1000	73 >	•
1000	EXECUTIVE	84 >	•
1000	JOTA	84 >	•
1000	RGS	82 > 83	•
1000	SFC	86 >	•

### MOTO GUZZI

750	NTX	90 >	•
750	S3	75 > 76	•
750	SP	91 >	•
750	V75	86 >	•
850	LE MANS	76 > 80	•
850	LE MANS III	81 > 84	•
850	LE MANS T4 (GERMANY)	85 >	•
850	T3	75 >	•
850	T3 CALIFORNIA	76 >	•
850	T3 CARABINIERI	83 >	•
850	T3 GERMANIA	75 >	•
850	T3 POLIZIA	83 >	•
850	T4	83 >	•
850	T5	85 > 88	•
1000	CALIFORNIA II	83 > 86	•
1000	CALIFORNIA III	87 > 93	•
1000	GS CONVERT	75 >	•
1000	GS CONVERT GERMANIA	75 >	•
1000	GT 1000	87 > 91	•
1000	LE MANS IV	85 > 89	•
1000	S 1000	89 > 94	•
1000	SP 1000	78 >	•



1000 SP 1000 II	83 > 88	• •
1000 SP 1000 III	89 > 94	• •
1000 STRADA	93 > 94	• •
1000 V	93 >	•
1000 V CALIFORNIA	70 >	• •
1000 V I CONVERT	70 >	•
1100 CALIFORNIA	94 > 97	• •
1100 SPORT	01 >	•

**MZ**

125 ETZ	82 >	•
125 ROADSTER	70 >	•
125 ROADSTER	93 >	•
150 ETZ	82 >	•
250 ETZ	82 >	•
251 ETZ	81 >	•
251 SAXON TOUR	96 >	•

251 SPORTSTAR MUZ	96 >	•
300 ETZ LUX	90 >	•
300 ETZ X	88 >	•
301 ETZ	90 >	•
301 SAXON TOUR	70 >	•
301 SPORTSTAR MUZ	96 >	•
500 SAXON COUNTRY	92 >	•
500 SAXON FUN	92 >	•
500 SAXON VOYAGER	70 >	•
500 SILVER STAR CLASSIC	93 >	•

**NORTON**

COMMANDER	90 >	• •
F 1	90 >	•
INTERPOL	83 >	• •
WANKEL CLASSIC	88 >	• •

**OSSA**

500 YANQEE	78 >	•
------------	------	---

**SWM**

350 SAHARA	70 >	•
------------	------	---

**TRIUMPH**

750 BONNEVILLE	87 >	• •
----------------	------	-----

**ZÜNDAPP**

175 KS	81 >	•
--------	------	---



<b>07BB15.07</b>	69.7 x 51 x 8.4
<b>07BB15.35</b>	“ “ “
<b>GENUINE</b>	
<b>07BB15.SA</b>	“ “ “
<b>07BB15.SC</b>	“ “ “
<b>07BB15.RC</b>	“ “ “

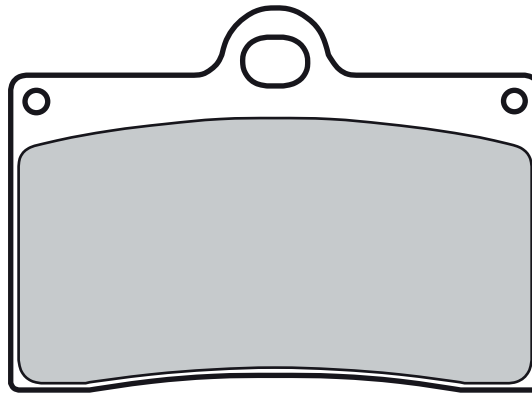

### APRILIA

250 AF1 REPLICA	90 >	•
250 RS	95 > 97	•

### BETA

125 JONATHAN	99 >	•
350 4.0 MOTARD	04 >	•
350 EURO	99 >	•
350 JONATHAN	02 >	•

### BIMOTA

400 YB 7	89 >	•
500 V-DUE	97 >	•
600 BELLARIA	90 > 92	•
600 BELLARIA	93 >	•
600 YB 9 SR	97 >	•
600 YB 9 SRI	97 >	•
650 BB1 SUPERMONO	97 >	•
750 SB7	94 >	•
750 YB 4	88 >	•
851 TESI	91 >	•
900 DB2	93 >	•
900 DB2 SR	94 >	•
900 MANTRA	97 >	•
906 TESI	91 >	•
1000 DB 1	91 >	•
1000 DB 1 RS	87 >	•
1000 FURANO	92 >	•
1000 TESI 2D	04 > 06	•
1000 TUATARA	90 >	•
1000 YB 11	97 >	•
1000 YB 6	87 >	•
1000 YB 8	89 >	•
1100 SB6	94 > 96	•
1100 SB6	97 >	•

### CAGIVA

125 MITO 2	92 > 93	•
125 MITO 525	08 >	•
125 MITO EURO2	04 >	•
125 MITO EV	94 > 03	•
125 N1	96 >	•
125 PLANET	98 > 00	•

125 RAPTOR	03 > 04	•
125 SP MITO 525	08 >	•
500 MITO	07 >	•
500 RIVER	99 >	•
525 SP MITO	08 >	•
600 RIVER	94 >	•

### DUCATI

350 350 SUPERSPORT	92 >	•
400 400 SUPERSPORT	93 > 97	•
400 MONSTER 400	95 > 97	•
500 502 SINGLE	93 >	•
500 502 SUPERMONO	93 >	•
600 600 SUPERSPORT	91 > 97	•
600 MONSTER 600	93 > 97	•
600 MONSTER 600	98 >	•
600 MONSTER 600 CITY	99 >	•
600 MONSTER 600 DARK	98 >	•
600 MONSTER 600 DARK CITY	99 >	•
748 748 BIPOSTO	95 > 97	•
748 748 BIPOSTO	98 > 98	•
748 748 SP	95 > 97	•
750 750 SUPERSPORT	91 > 98	•
750 F1	86 >	•
750 LAGUNA SECA	87 >	•
750 MONSTER 750 (BIDISCO)	96 > 98	•
750 MONSTER 750 (MONODISCO)	96 > 97	•
750 MONSTER 750 CITY, DARK CITY	99 >	•
851 851	89 >	•
851 851 SP2	90 >	•
851 851 SP3	91 >	•
851 851 SUPERBIKE	91 >	•
888 888 RACING	92 >	•
888 888 SP	92 >	•
888 888 SP4	92 >	•
888 888 SP5	93 >	•
888 888 SUPERBIKE STRADA	94 > 95	•
900 FE	97 >	•
900 MONSTER 900	93 > 99	•

900 MONSTER 900 CITY	99 >	•
900 MONSTER 900 CROMO	98 >	•
900 MONSTER 900 DARK CITY	99 >	•
900 MONSTER 900 SPECIAL	98 >	•
900 SUPERLIGHT 900	92 > 97	•
900 SUPERSPORT 900	90 > 97	•
907 907 I.E.	92 >	•
916 916	94 > 96	•
916 916 BIPOSTO SENNA	94 > 98	•
916 916 S	94 > 96	•
916 916 SP	94 > 96	•
916 916 SPS	97 >	•

### FANTIC MOTOR

125 SM	12 >	•
--------	------	---

### GAS GAS

125 SM	02 >	•
250 SM	02 >	•
400 FSE SM	02 >	•
450 FSE SM	03 > 06	•
450 SM FSR	07 >	•

### GILERA

350 SATURNO	88 >	•
500 SATURNO	88 >	•
600 SATURNO PIUMA	90 >	•

### HONDA

125 RS (GP)	95 >	•
250 RS R	93 >	•

### HUSQVARNA

400 SM R	02 >	•
450 SMR	03 > 04	•
570 R	01 >	•
570 SMR	01 > 02	•
570 SMR	03 > 04	•
570 SMR R	04 >	•



**INDIAN**

1700 CHIEF BLACKHAWK	11 > 13	•
1700 CHIEF BOMBER	10 > 13	•
1700 CHIEF CLASSIC	10 > 13	•
1700 CHIEF DARK HORSE	10 > 13	•
1700 CHIEF DELUXE	09 > 13	•
1700 CHIEF ROADMASTER	09 > 13	•
1700 CHIEF STANDAR	09 > 13	•
1700 CHIEF VINTAGE	09 > 13	•

**ITALJET**

900 GRIFON	00 >	•
------------	------	---

**KTM**

125 STING	99 >	•
400 DUKE	94 > 95	•
450 SM FACTORY REPLICA	04 >	•
525 SMR	04 > 04	•
620 DUKE 4T	94 > 97	•
640 DUKE	98 >	•
640 LC4 SUPERMOTO	03 > 04	•
660 SM FACTORY	02 >	•
660 SM FACTORY REPLICA	03 >	•
660 SMC	03 > 03	•
660 SMS	07 >	•

**LAVERDA**

650 FORMULA	94 > 95	•
650 GHOST	96 >	•
650 SPORT	94 > 95	•
650 STRADA	96 >	•
668 668	96 >	•
668 DIAMANTE	96 > 98	•
668 GHOST STRIKE LEGEND	96 > 98	•
750 CUP	98 >	•
750 DIAMANTE	97 >	•

750 GHOST STRIKE	97 >	•
750 S	97 > 98	•
750 S FORMULA	99 > 00	•
750 S SCARENATO	97 > 98	•
750 S SPORT	99 > 00	•
750 STRIKE BIFARO	98 > 99	•
750 STRIKE MONOFARO	98 > 99	•
750 T8	98 >	•
800 TTS	99 >	•

**MOTO GUZZI**

1000 DAYTONA	92 > 95	•
1000 DAYTONA RACING	92 > 96	•
1000 DAYTONA RS	97 > 98	•
1000 V10 CENTAURO	97 > 99	•
1000 V10 CENTAURO SPORT	98 > 99	•
1100 CALIFORNIA EV TOURING	97 > 00	•
1100 CALIFORNIA JACKAL BASIC	00 >	•
1100 CALIFORNIA SPECIAL	99 > 00	•
1100 SPORT	94 > 96	•
1100 SPORT CORSA	98 > 99	•
1100 SPORT I.E.	96 > 99	•

**MZ**

660 SKORPION CUP MUZ	99 >	•
660 SKORPION REPLICA MUZ	97 >	•

**NORTON**

F 1	90 >	•
TT	92 >	•

**PGO**

250 G-MAX	06 >	•
-----------	------	---

**SACHS**

125 X-ROAD 4T	05 >	•
125 XTC	99 >	•
125 XTC N	99 >	•
650 ROADSTER	01 >	•
800 B 805	02 >	•
800 ROADSTER	00 >	•
800 S 805	03 >	•

**TM**

125 SMR	05 >	•
125 SMX	06 >	•
400 SMR F	02 > 02	•
400 SMR F	03 >	•
450 SMR F	04 >	•
450 SMX F	03 >	•
530 SMR F	03 >	•
530 SMR F ES	03 >	•
600 SMX F	03 >	•

**VOR**

400 SM	02 >	•
450 SM	02 >	•
500 SUPERMOTARD (492)	00 > 01	•
530 SM	02 >	•

**VOXAN**

1000 CAFE' RACER	01 >	•
1000 ROADSTER	01 >	•

**YAMAHA**

125 TZR R ITALIA	92 >	•
250 TZR R	94 >	•
660 SZR	96 >	•



**07BB16.06** 100.1 x 51.7 x 7.6

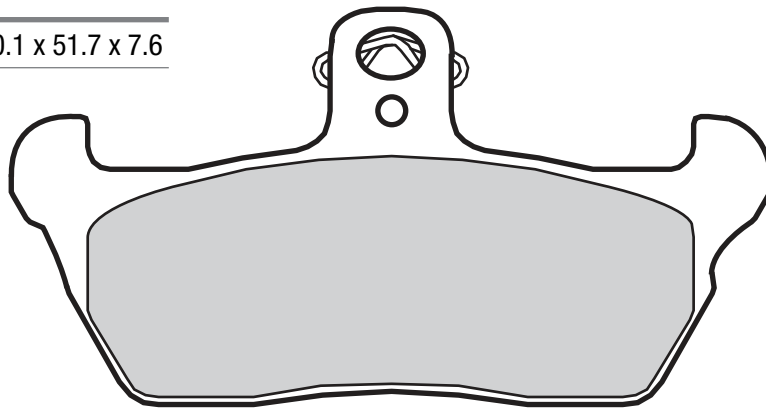

**APRILIA**

125 RX	91 > 91	•
125 TUAREG RALLY	90 > 91	•
350 TUAREG	88 >	•
350 TUAREG WIND	90 >	•
600 TUAREG	88 >	•
600 TUAREG WIND	90 >	•

**CAGIVA**

50 SUPER CITY	93 >	•
80 SUPER CITY	94 >	•
125 K 7	90 >	•
125 MITO	90 >	•
125 N 90	90 >	•
125 SUPER CITY	92 >	•
125 TAMANACO	89 >	•

125 W9	96 >	•
350 W12	92 >	•
500 W16	94 > 98	•
600 W16	94 >	•
750 ELEFANT BIFARO	90 >	•

**GILERA**

125 APACHE	91 > 93	•
600 R, RC	91 >	•

**MOTO GUZZI**

1000 QUOTA	92 > 95	•
------------	---------	---

**MOTO MORINI**

350 COGUARO	89 >	•
-------------	------	---

350 COGUARO NEW YORK	89 >	•
350 DART	87 > 87	•
350 DART	88 > 89	•
350 EXCALIBUR	87 >	•
350 KANGURO	87 >	•
400 DART	90 >	•
501 COGUARO	89 >	•
501 EXCALIBUR	90 >	•
501 KANGURO	87 >	•
501 NEW YORK	89 >	•

**SUZUKI**

250 WOLF	90 >	•
----------	------	---

**YAMAHA**

125 TDR R ITALIA	92 >	•
------------------	------	---



**07BB18.34**  
GENUINE 39.8 x 49.5 x 7

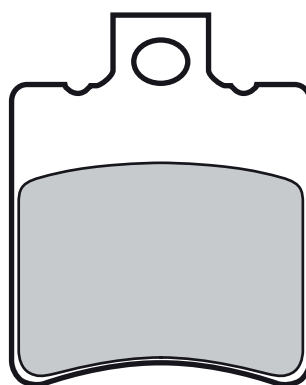

**APRILIA**

125 RX	85 > 85	•
250 RS	95 > 97	•
250 RS	98 > 01	•

**BIMOTA**

1000 SB8 K GOBERT	04 >	•
-------------------	------	---

**GARELLI**

125 TIGER XR	83 >	•
125 TIGER XRD	83 >	•



<b>07BB19.07</b>	75.1 x 55.5 x 8.7
<b>07BB19.35</b>	“ “ “
<b>GENUINE</b>	
<b>07BB19.73</b>	“ “ “
<b>GENUINE</b>	
<b>07BB19.90</b>	“ “ “
<b>GENUINE</b>	
<b>07BB19.SA</b>	“ “ “
<b>07BB19.SC</b>	“ “ “
<b>07BB19.RC</b>	“ “ “

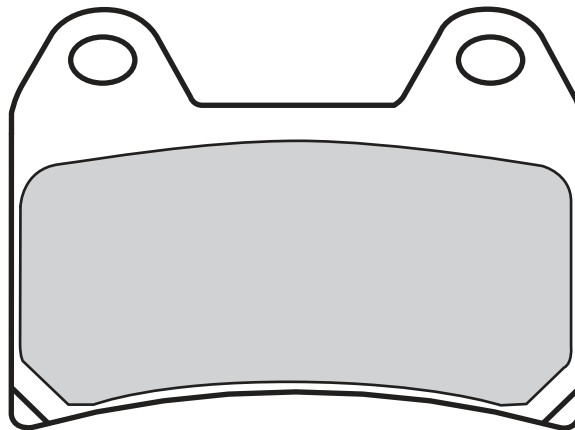

### APRILIA

250 RS	98 > 01	•
650 PEGASO STRADA	05 >	•
750 DORSODURO FACTORY	12 >	•
750 SMV DORSODURO	08 > 08	•
1000 BLUE MARLIN	02 >	•
1000 RST FUTURA	01 > 04	•
1000 RSV	97 > 01	•
1000 RSV R	00 > 00	•
1000 RSV SP	99 >	•
1000 RSV TUONO 4R	11 >	•
1000 SL FALCO	00 > 04	•
1000 TUONO ABS	13 >	•
1000 TUONO FIGHTER	03 >	•
1200 DORSODURO	11 >	•
1200 DORSODURO ABS	11 >	•

### BENELLI

125 BORN IN HELL	98 >	•
500 LEONCINO	16 >	•
502 TRK	16 >	•
899 TNT	07 >	•
899 TRE 899 K	09 >	•
900 TORNADO 3	00 > 02	•
1130 TNT	04 >	•
1130 TNT	05 >	•

1130 TRE K

06 > •

### BIMOTA

900 DB4	99 >	•
1000 SB8 K GOBERT	04 >	•
1000 SB8 K SANTAMONICA	06 > 06	•
1000 SB8 R	98 >	•

### BMW

650 G 650 XMOTO	07 >	•
800 F 800 GT	13 >	•
800 F 800 R	09 > 14	•
800 F 800 S	06 >	•
800 F 800 S	09 >	•
800 F 800 ST	06 >	•
800 F 800 ST TOURING	11 >	•
1170 R NINE T SCRAMBLER	16 >	•

### CAGIVA

125 RAPTOR	05 >	•
650 RAPTOR	01 > 05	•
650 V-RAPTOR	01 > 05	•
1000 RAPTOR	00 >	•
1000 V-RAPTOR	00 >	•
1000 X3 RAPTOR	04 >	•

1000 XTRA RAPTOR

02 > •

### DUCATI

400 MONSTER 400	03 > 04	•
400 MONSTER 400 (MONODISCO)	05 >	•
400 MONSTER 400 DARK	03 >	•
600 MONSTER 600	00 >	•
600 MONSTER 600 DARK	00 >	•
600 MONSTER 600 DARK CITY	00 >	•
600 MONSTER 600 METALLIC	00 > 01	•
620 MONSTER 620 (BIDISCO)	05 >	•
620 MONSTER 620 DARK	03 >	•
620 MONSTER 620 DARK (MONODISCO)	04 >	•
620 MONSTER 620 DARK (MONODISCO)	05 >	•
620 MONSTER 620 I.E	02 >	•
620 MONSTER 620 I.E	03 >	•
620 MONSTER 620 I.E DARK	02 >	•
620 MONSTER 620 S I.E.	02 >	•
620 MONSTER 620 S I.E.	03 >	•
620 MONSTER 620, DARK	04 >	•



620	MULTISTRADA 620 DARK (MONODISCO)	05 >	•
620	MULTISTRADA 620 SD	03 >	•
620	SUPERSPORT 620 S	03 >	•
748	748	00 > 02	•
748	748 BIPOSTO	99 >	•
748	748 R	00 >	•
748	748 S	00 > 02	•
748	748 SPS	98 > 99	•
750	750 SUPERSPORT	99 >	•
750	750 SUPERSPORT I.E.	00 > 02	•
750	750 SUPERSPORT S I.E.	02 >	•
750	MONSTER 750 DARK	00 > 01	•
750	MONSTER 750 DARK I.E.	02 >	•
750	MONSTER 750 METALLIC	00 > 01	•
750	SPORT	00 >	•
803	MONSTER 800	04 >	•
803	MONSTER 800 S I.E.	03 >	•
803	SUPERSPORT 800	06 >	•
803	SUPERSPORT 800 S	03 >	•
848	848	08 >	•
848	STREETFIGHTER	12 >	•
848	STREETFIGHTER S	12 >	•
900	MH 900 EVOLUTION	01 > 02	•
900	MONSTER 900 CROMO I.E.	00 >	•
900	MONSTER 900 CROMO I.E.	01 >	•
900	MONSTER 900 DARK I.E.	01 >	•
900	MONSTER 900 DARK I.E.	02 >	•
900	MONSTER 900 I.E.	00 >	•
900	MONSTER 900 METALLIC I.E.	00 > 01	•
900	MONSTER 900 METALLIC I.E.	00 >	•
900	MONSTER 900 METALLIC I.E.	01 >	•
900	MONSTER 900 S I.E.	00 >	•
900	MONSTER 900 S I.E.	01 >	•
900	SPORT TOURING 4	99 >	•
900	SUPERSPORT 900	98 > 99	•
900	SUPERSPORT 900 I.E.	00 > 02	•
900	SUPERSPORT 900 S I.E.	02 >	•
916	916 SPS	98 >	•
916	MONSTER S4	02 > 03	•
916	MONSTER S4 FOGGY	02 > 03	•
916	ST4	99 > 99	•
916	ST4	00 > 03	•
916	ST4 S	03 > 04	•
916	ST4 S ABS	03 > 04	•
944	SPORT TOURING 2	99 > 00	•
992	ST3	04 >	•
992	ST3 ABS, ST3 S ABS	07 >	•
992	ST4, ST4 ABS	05 >	•
992	SUPERSPORT 1000	06 >	•
992	SUPERSPORT 1000 DS	05 >	•
992	SUPERSPORT 1000 S	03 >	•
996	996	99 >	•
996	996	00 >	•
996	996	01 >	•

996	996 S	00 >	•
996	996 SPS	99 >	•
996	996 SPS II	99 >	•
996	996 SPS III	00 >	•
996	MONSTER S4 R	03 > 03	•
996	MONSTER S4 R	04 >	•
998	998	02 >	•
998	998 MATRIX	04 >	•
1000	MONSTER 1000	04 > 05	•
1000	MONSTER 1000 S	05 >	•
1000	MONSTER 1000 S I.E.	03 >	•
1000	MONSTER S2 R 1000	06 >	•
1000	MULTISTRADA 1000 DS	03 >	•
1000	MULTISTRADA 1000 S DS	05 >	•
1100	HYPERMOTARD	07 >	•
1100	HYPERMOTARD EVO	10 >	•
1100	MONSTER	09 >	•
1100	MONSTER EVO ABS	11 >	•
1100	MONSTER S	09 >	•
1100	MULTISTRADA	07 > 09	•
1100	MULTISTRADA S	07 > 09	•
1200	MULTISTRADA	10 > 14	•
1200	MULTISTRADA ABS	10 >	•
1200	MULTISTRADA S GT	12 > 14	•
1200	MULTISTRADA S PIKES PEAK	11 > 14	•
1200	MULTISTRADA S TOURING	13 > 14	•
1200	MULTISTRADA TOURING ABS	10 > 14	•

**HOREX**

1200	VR6	11 >	•
------	-----	------	---

**HUSQVARNA**

570	NOX	01 > 03	•
610	LT	00 >	•
610	SM	98 > 99	•
610	SMS	00 > 01	•
610	SMS	03 > 04	•
610	TE E LT	00 >	•
630	SMR	04 >	•
900	NUDA	12 >	•
900	NUDA ABS	12 >	•

**KTM**

625	SMC	05 >	•
640	DUKE II	99 > 04	•
640	DUKE II	05 > 07	•
640	LC4 SUPERMOTO	05 >	•
660	SMC	04 > 05	•
660	SMC	06 >	•
690	DUKE	15 >	•
690	DUKE ABS	12 >	•
690	SUPERMOTO	07 >	•
1050	ADVENTURE	15 >	•
1190	ADVENTURE	13 >	•
1290	SUPER ADVENTURE	15 >	•

**MOTO GUZZI**

750	BREVA 750 I.E.	03 > 06	•
750	NEVADA	03 >	•

750	NEVADA CLASSIC I.E.	06 >	•
750	V7 CAFE' CLASSIC	10 >	•
750	V7 CLASSIC	09 >	•
750	V7 CLUBMAN RACER	10 >	•
750	V7 II RACER	15 >	•
750	V7 II SPECIAL	15 >	•
750	V7 II STONE	15 >	•
750	V7 II STORNELLO	16 >	•
750	V7 RACER	11 >	•
750	V7 SPECIAL	12 >	•
750	V7 STONE	12 >	•
850	BREVA	06 >	•
850	GRISO	06 >	•
850	V9 BOBBER	16 >	•
850	V9 CUSTOM ROAMER	16 >	•
1100	BREVA	05 > 07	•
1100	BREVA ABS	05 > 07	•
1100	CALIFORNIA ALUMINIUM	03 >	•
1100	CALIFORNIA CLASSIC	06 >	•
1100	CALIFORNIA EV	01 > 02	•
1100	CALIFORNIA EV	03 >	•
1100	CALIFORNIA EV SPORT	01 > 02	•
1100	CALIFORNIA EV TOURING	01 > 05	•
1100	CALIFORNIA EV TOURING	03 >	•
1100	CALIFORNIA EV TOURING	04 >	•
1100	CALIFORNIA EV TOURING	06 >	•
1100	CALIFORNIA JACKAL	99 > 01	•
1100	CALIFORNIA JACKAL BASIC	01 >	•
1100	CALIFORNIA METAL	02 >	•
1100	CALIFORNIA SPECIAL	01 >	•
1100	CALIFORNIA SPECIAL ALUMINIUM	02 >	•
1100	CALIFORNIA SPECIAL SPORT	02 >	•
1100	CALIFORNIA STONE	01 > 05	•
1100	CALIFORNIA STONE	02 >	•
1100	CALIFORNIA TITANIUM	03 >	•
1100	CALIFORNIA TOURING	06 >	•
1100	CALIFORNIA VINTAGE	07 >	•
1100	GRISO	05 >	•
1100	SPORT	01 >	•
1100	V11 BALLABIO	03 >	•
1100	V11 CAFE SPORT	03 >	•
1100	V11 COPPA ITALIA	04 >	•
1100	V11 LE MANS	01 > 02	•
1100	V11 LE MANS	01 >	•
1100	V11 LE MANS	03 >	•
1100	V11 NAKED	01 > 02	•
1100	V11 NAKED	03 >	•
1100	V11 SCURA	02 >	•
1100	V11 SPORT	01 > 02	•
1100	V11 SPORT ROSSO	01 >	•
1200	BREVA	11 >	•
1200	GRISO 8V	07 >	•
1200	NORGE	06 >	•
1200	NORGE ABS	06 >	•
1200	NORGE GT 8V	08 >	•
1200	SPORT	06 >	•
1200	SPORT 4V	09 > 11	•



1200 SPORT 4V	09 >	•
1200 SPORT 8V	12 >	•
1200 SPORT 8V SE	12 >	•
1200 SPORT ABS	06 >	•
1200 STELVIO	08 > 11	•
1200 STELVIO 8V SE	12 >	•
1200 STELVIO NTX	09 > 11	•
1400 AUDACE	15 >	•
1400 CALIFORNIA CUSTOM	13 >	•
1400 CALIFORNIA TOURING	13 >	•
1400 ELDORADO	15 >	•

**MOTO MORINI**

1200 1200 SPORT	09 >	•
1200 9 1/2	06 >	•
1200 CORSARO	06 >	•

**MV AGUSTA**

675 BRUTALE	12 >	•
675 F3	11 > 14	•
800 BRUTALE RR	15 >	•
800 DRAGSTER	15 >	•
800 DRAGSTER RR	15 >	•
800 DRAGSTER RR LH44	15 >	•
920 BRUTALE	12 >	•
989 BRUTALE R	08 >	•
990 BRUTALE R	10 >	•
1090 BRUTALE R	12 >	•

**MZ**

1000 MUZ S	01 > 02	•
------------	---------	---

**NORTON**

961 COMMANDO SE	10 > 11	•
961 COMMANDO SF SPORT	11 >	•

**SACHS**

500 MADASS	05 >	•
------------	------	---

**SUZUKI**

1200 GSX	99 > 01	•
----------	---------	---

**VOXAN**

1000 EVO	04 >	•
----------	------	---

**YAMAHA**

400 XJR	95 >	•
660 XT X	04 >	•
850 TRX	95 >	•
1200 XJR ITALIA	95 > 98	•



**07BB20.35**  
GENUINE 50.8 x 53.7 x 7.4

**07BB20.65**  
GENUINE “ “ “

**07BB20.9A**  
GENUINE “ “ “

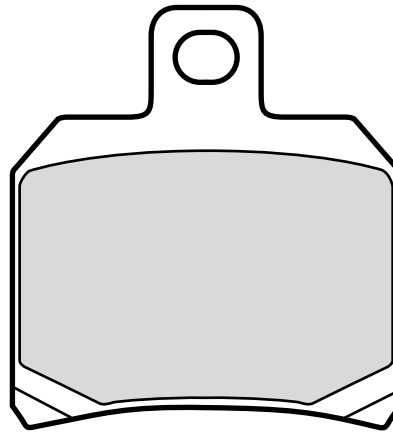

### APRILIA

1000 BLUE MARLIN	02 >	•
1000 ETV CAPO NORD	01 > 03	•
1000 ETV CAPO NORD ABS	04 >	•
1000 ETV CAPO NORD RALLY RAID	04 >	•
1000 RSV	97 > 01	•
1000 RSV	02 >	•
1000 RSV 4RF	15 >	•
1000 RSV 4RR	15 >	•
1000 RSV FACTORY	03 >	•
1000 RSV NERA	04 >	•
1000 RSV R	00 > 00	•
1000 RSV R	01 >	•
1000 RSV SP	99 >	•
1000 RSV TUONO 4R	11 >	•
1000 RSV4 FACTORY	09 >	•
1000 RSV4 FACTORY APRC	11 > 12	•
1000 RSV4 FACTORY APRC ABS	13 >	•
1000 RSV4 R	10 >	•
1000 RSV4 R APRC ABS	14 >	•
1000 SL FALCO	00 > 04	•
1000 TUONO	13 >	•
1000 TUONO ABS	13 >	•
1000 TUONO FIGHTER	03 >	•
1000 TUONO R	03 >	•
1000 TUONO RACING	04 >	•
1000 TUONO V4R APRC ABS	14 >	•
1100 TUONO V4 FACTORY	15 >	•
1100 TUONO V4 FACTORY RR	15 >	•
1200 CAPONORD RALLY	15 >	•

### BENELLI

300 BN 302	14 >	•
300 BN 302 TORNADO	16 >	•
302 TORNADO	16 >	•
500 LEONCINO	16 >	•
502 TRK	16 >	•
600 BN	14 >	•
600 BN GT	14 >	•
600 BN R	15 >	•
899 TNT	07 >	•
899 TNT CENTURY RACER	11 >	•

900 TORNADO 3	03 >	•
1130 TNT	04 >	•
1130 TNT	05 >	•
1130 TNT CAFE' RACER	05 >	•
1130 TNT CENTURY RACER	11 >	•
1130 TNT OFFICINE	07 >	•
1130 TNT R 160	10 >	•
1130 TNT SPORT	05 >	•
1130 TNT TITANIUM	05 >	•
1130 TORNADO TRE	06 >	•
1130 TORNADO TRE R	13 >	•
1130 TRE K	06 >	•
1130 TRE K AMAZONAS	13 >	•

### BIMOTA

800 TESI 3D RACECAFE'	16 >	•
1000 BB3	13 >	•
1078 TESI 3D NAKED	16 >	•
1100 TESI 3D	07 >	•
1198 DB8	10 >	•
1198 IMPETO	16 >	•
1200 DB11 VLX (RED CALL)	13 >	•
1200 DB12	12 >	•

### BOMBARDIER-CAN AM

500 TRAXTER 4X4	99 > 00	• •
-----------------	---------	-----

### CAGIVA

650 RAPTOR	01 > 05	•
650 V-RAPTOR	01 > 05	•
1000 RAPTOR	00 >	•
1000 V-RAPTOR	00 >	•
1000 X-RAPTOR	03 >	•
1000 X3 RAPTOR	04 >	•
1000 XTRA RAPTOR	02 >	•

### DUCATI

400 SCRAMBLER	15 >	•
620 MULTISTRADA 620 SD	03 >	•
659 MONSTER 659	12 > 13	•
659 MONSTER 659 ABS	12 > 14	•
696 MONSTER 696	08 >	•

696 MONSTER 696 / MONSTER 696 +	09 >	•
696 MONSTER 696 ABS	10 > 14	•
696 MONSTER 696 ANNIVERSARY / ABS	13 >	•
748 749	03 > 07	•
748 749 DARK	05 > 06	•
748 749 R	03 > 07	•
748 749 S	03 > 07	•
795 MONSTER 795	12 > 14	•
795 MONSTER 795	14 >	•
795 MONSTER 795 ABS	13 > 15	•
795 MONSTER 795 ABS CORSE STRIPE	14 >	•
796 HYPERMOTARD	10 >	•
796 MONSTER	11 >	•
796 MONSTER 796	11 >	•
796 MONSTER 796 ABS	11 >	•
796 MONSTER 796 ABS ANNIVERSARY	13 >	•
796 MONSTER 796 ANNIVERSARY	13 >	•
796 MONSTER ABS	11 >	•
796 MONSTER ABS ANNIVERSARY	13 >	•
796 MONSTER ANNIVERSARY	13 >	•
803 HYPERMOTARD SP	13 >	•
803 HYPERSTRADA	13 >	•
803 SCRAMBLER CLASSIC	15 >	•
803 SCRAMBLER FULL THROTTLE	15 >	•
803 SCRAMBLER ICON	15 >	•
803 SCRAMBLER URBAN ENDURO	15 >	•
821 HYPERMOTARD SP	15 >	•
821 MONSTER 821	15 >	•
821 MONSTER 821 DARK	15 >	•
821 MONSTER 821 STRIPE	15 >	•
848 848	08 >	•
848 848 EVO	11 >	•
848 STREETFIGHTER	12 >	•
848 STREETFIGHTER S	12 >	•
899 PANIGALE	14 >	•



900	MH 900 EVOLUTION	01 > 02	•
939	HYPERMOTARD	16 >	•
939	HYPERMOTARD SP	16 >	•
939	HYPERSTRADA	16 >	•
959	PANIGALE	16 >	•
990	DESMOSEDICI RR (D16RR)	07 >	•
998	999	03 > 07	•
998	999 R	03 > 07	•
998	999 S	03 > 07	•
999	999 XEROX	06 >	•
1000	MULTISTRADA 1000 DS	03 >	•
1000	MULTISTRADA 1000 S DS	05 >	•
1098	1098 R BAYLISS	09 >	•
1098	STREETFIGHTER	09 >	•
1098	STREETFIGHTER S	09 >	•
1099	1098	07 >	•
1099	1098 S	07 >	•
1099	1098 TRICOLORE	07 >	•
1100	HYPERMOTARD	07 >	•
1100	HYPERMOTARD EVO	10 >	•
1100	HYPERMOTARD EVO SP	10 >	•
1100	HYPERMOTARD S	07 >	•
1100	MONSTER	09 >	•
1100	MONSTER EVO ABS	11 >	•
1100	MONSTER S	09 >	•
1100	MULTISTRADA	07 > 09	•
1100	MULTISTRADA S	07 > 09	•
1198	1098 BAYLISS	09 >	•
1198	1098 R	08 >	•
1198	1198	09 >	•
1198	1198 S	09 >	•
1198	1198 SP	11 >	•
1199	PANIGALE	12 >	•
1199	PANIGALE R	13 >	•
1199	PANIGALE S	12 >	•
1199	SUPERLEGGERA	14 >	•
1200	DIAVEL TITANIUM	15 >	•
1200	MONSTER	14 >	•
1200	MONSTER R	15 >	•
1200	MONSTER S	14 >	•
1200	MONSTER S STRIPE	15 >	•
1200	MULTISTRADA	10 > 14	•

1200	MULTISTRADA ABS	10 >	•
1200	MULTISTRADA S GT	12 > 14	•
1200	MULTISTRADA S PIKES PEAK	11 > 14	•
1200	MULTISTRADA S TOURING	13 > 14	•
1200	MULTISTRADA TOURING ABS	10 > 14	•
1262	XDIAVEL	16 >	•
1262	XDIAVEL S	16 >	•
1299	PANIGALE	15 >	•
1299	PANIGALE R	15 >	•
1299	PANIGALE S	15 >	•

### ENERGICA

11.7	EGO	15 >	•
11.7	EVA	15 >	•

### HONDA

1000	RCV213V	15 >	•
------	---------	------	---

### HOREX

1200	VR6	11 >	•
------	-----	------	---

### KAWASAKI

1000	H2	15 >	•
1000	H2 R	15 >	•

### KTM

1190	RC8	08 >	•
1190	RC8	09 >	•
1190	RC8 R	09 >	•
1190	RC8 R TRACK	11 >	•
1290	SUPER DUKE GT	16 >	•
1290	SUPER DUKE R	14 >	•

### LAVERDA

1000	SFC (LIMITED EDITION)	03 >	•
------	-----------------------	------	---

### MONDIAL

1000	PIEGA	02 >	•
------	-------	------	---

1000	PIEGA EVO	04 >	•
1000	PIEGA RZ NUDA	04 >	•

### MOTO GUZZI

750	V7 CAFE' CLASSIC	10 >	•
750	V7 CLASSIC	09 >	•
750	V7 CLUBMAN RACER	10 >	•
750	V7 RACER	11 >	•
750	V7 SPECIAL	12 >	•
750	V7 STONE	12 >	•

### MOTO MORINI

1200	1200 SPORT	09 >	•
1200	9 1/2	06 >	•
1200	CORSARO	06 >	•

### MV AGUSTA

675	BRUTALE	12 >	•
675	F3	11 > 14	•
675	F3	15 >	•
675	F3 RC	16 >	•
800	BRUTALE RR	15 >	•
800	DRAGSTER	15 >	•
800	DRAGSTER RR	15 >	•
800	DRAGSTER RR LH44	15 >	•
800	F3	13 >	•
800	F3 AMG GT	16 >	•
800	F3 RC	16 >	•
800	RIVALE	13 >	•
800	STRADALE	15 >	•
800	TURISMO VELOCE	14 >	•
800	TURISMO VELOCE LUSO	14 >	•

### NORTON

961	COMMANDO CAFE' RACER	11 >	•
961	COMMANDO SE	10 > 11	•
961	COMMANDO SE	12 >	•
961	COMMANDO SF	13 >	•
961	COMMANDO SF SPORT	11 >	•



**07BB21.07** 57.6 x 53.6 x 8.9  
**07BB21.SA** “ “ “

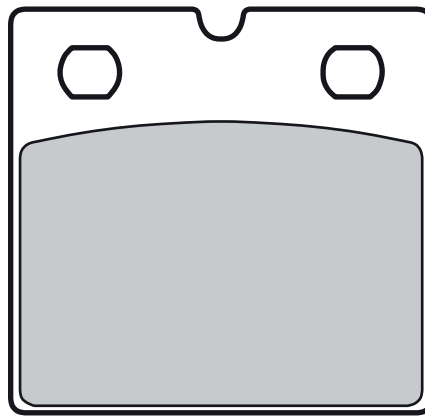

**BMW**

750 K 75 ABS (SPECIAL CALIPER) 91 > •

750 K 75 RT  
 800 R 80 R

91 > •  
 93 > •

1000 K 100 ABS (SPECIAL CALIPER)  
 1000 R 100 RS

91 > •  
 93 > •



**07BB22.07** 99.6 x 55.6 x 8.3  
**07BB22.SA** “ “ “

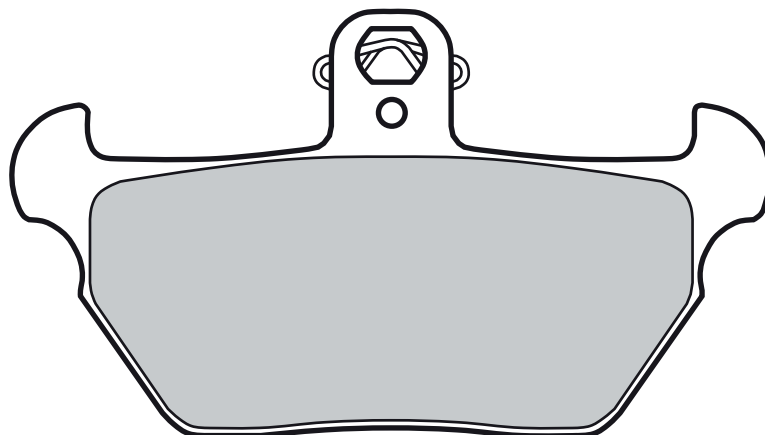

**BMW**

800 R 80 R 92 > 92 •  
 1000 K 1 89 > •

1000 K 100 LT  
 1000 K 100 RS 16V  
 1000 R 100 R  
 1000 R 100 R

92 > •  
 90 > •  
 91 > 91 •  
 92 > •

1100 K 1100 LT (no ABS)  
 1100 K 1100 RS  
 1100 R 1100 RS

92 > •  
 93 > •  
 93 > •





**07BB23.07** 59.7 x 58.5 x 9

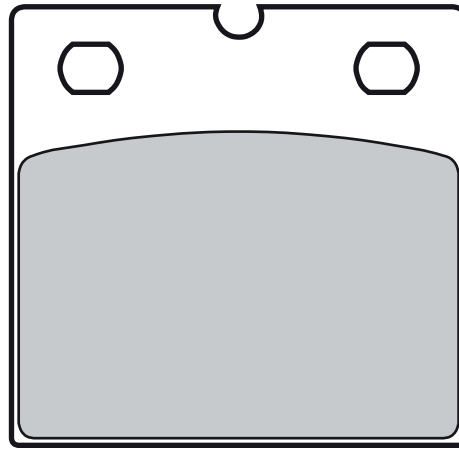

**BENELLI**

900 SEI 78 > •

1000 R 100 GS  
1000 R 100 RT

88 > •  
91 > 95 •

1000 CALIFORNIA II  
GS CONVERT  
GERMANIA  
1000 SP 1000

83 > 86 •  
75 > •  
78 > •

**BMW**

650 R 65/1 86 > •  
800 R 80 GS 88 > •  
800 R 80 RT 85 > •

**MOTO GUZZI**

850 LE MANS 76 > 80 •  
850 T3 CALIFORNIA 76 > •  
850 T3 GERMANIA 75 > •

**TRIUMPH**

750 BONNEVILLE 84 > 86 •



**07BB24.07** 100 x 56.1 x 8.4

**07BB24.SA** “ “ “

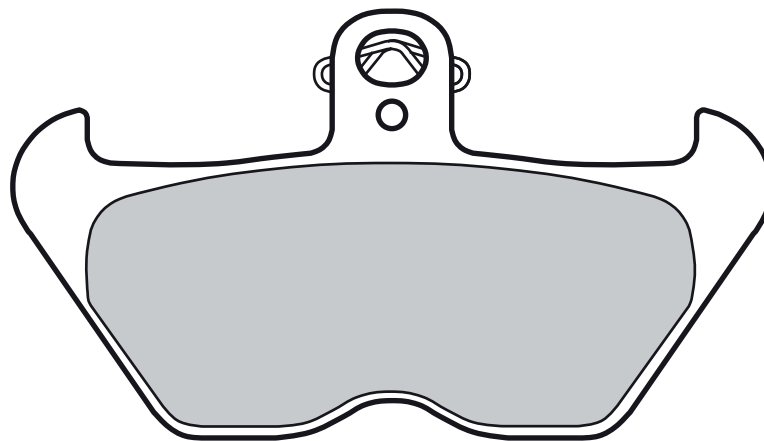

**BMW**

850 R 850 C 99 > •  
850 R 850 GS 99 > •  
850 R 850 R 96 > 02 •  
850 R 850 ROADSTER 96 > 02 •

850 R 850 RT 98 > 00 •  
1100 R 1100 GS 94 > •  
1100 R 1100 R 95 > 98 •  
1100 R 1100 R 99 > •  
1100 R 1100 RS 94 > •  
1100 R 1100 RT 95 > •

1100 R 1100 S 99 > 00 •  
1150 R 1150 GS 00 > 01 •  
1200 K 1200 LT 99 > 00 •  
1200 K 1200 RS 97 > 00 •  
1200 R 1200 C 98 > 02 •



**07BB25.07** 74.9 x 54.6 x 8.9

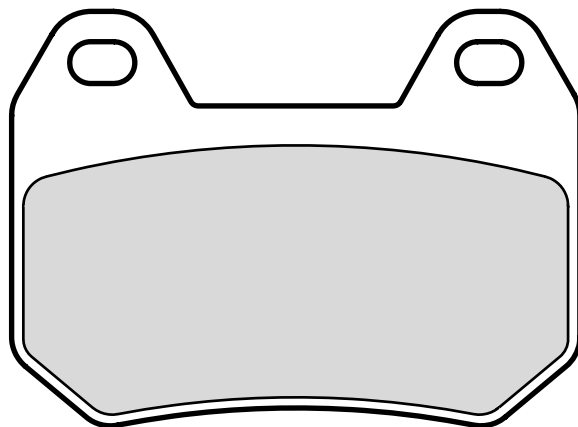

**BMW**

1200 K 1200 LT	99 > 00	•
1200 K 1200 LT ABS	01 >	•
1200 R 1200 CL	03 >	•



**07BB26.07** 77 x 51.4 x 8.6

**07BB26.SA** “ “ “

**07BB26.SC** “ “ “

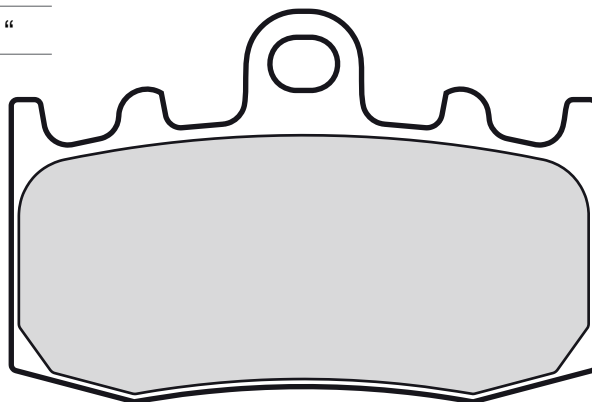

**BMW**

850 R 850 RT ABS	01 >	•
1100 R 1100 S	01 >	•
1150 R 1150 GS	01 > 02	•
1150 R 1150 GS ADVENTURE	01 > 02	•
1150 R 1150 RT	01 >	•
1200 HP2 MEGAMOTO	07 >	•
1200 K 1200 GT	02 > 07	•

1200 K 1200 GT	08 >	•
1200 K 1200 GT ABS	02 > 07	•
1200 K 1200 GT ABS	08 >	•
1200 K 1200 RS	01 >	•
1200 K 1200 S	05 > 08	•
1200 K 1200 S ABS	05 > 08	•
1200 R 1200 CL	03 >	•
1200 R 1200 GS	04 > 12	•
1200 R 1200 GS ABS	04 > 12	•

1200 R 1200 GS ADVENTURE	06 > 13	•
R 1200 GS TRIPPLE		
1200 BLACK	11 >	•
1200 R 1200 RT	05 >	•
1200 R 1200 S	06 >	•
1200 R 1200 ST	06 >	•
1300 K 1300 GT	09 >	•
1300 K 1300 S	09 >	•



**07BB27.5A**  
GENUINE 64 x 41.8 x 11

**07BB27.SD** 64 x 41.8 x 9

**07BB27.SX** “ “ “

**07BB27.TT** “ “ “

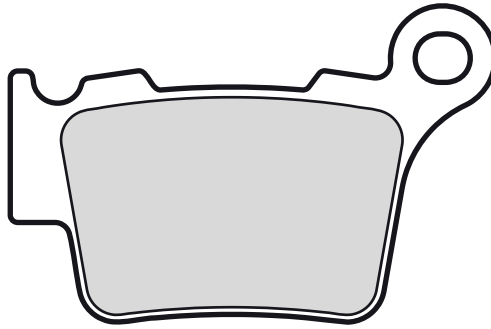
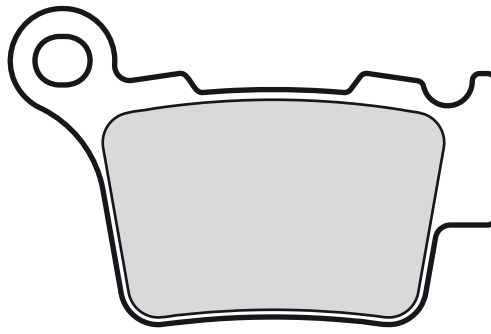

### BMW

450 ENDURO	08 >	•
450 G 450 SMR	09 >	•
450 G 450 X	09 >	•

### HUSABERG

125 TE	13 >	•
250 FE	13 >	•
250 TE	11 >	•
300 TE	11 >	•
350 FE	13 >	•
390 FE	10 >	•
450 FE	09 >	•
501 FE	13 >	•
570 FE	09 >	•

### HUSQVARNA

125 CR	05 >	•
125 TC	14 >	•
125 TE	11 > 12	•
125 TE	14 >	•
125 TE 4T	11 >	•
125 WR	05 > 10	•
125 WR	11 >	•
250 CR	05 >	•
250 FC	14 >	•
250 FE	14 >	•
250 SMR	06 >	•
250 TC	14 >	•
250 TE	14 >	•
250 TE 4T	10 >	•
300 TC	14 >	•
300 TE	14 >	•
300 WR	09 >	•
310 TE	10 > 12	•

310 TE 4T	10 >	•
350 FC	14 >	•
350 FE	14 >	•
449 SMR	11 >	•
449 TC 449	04 >	•
449 TE 449	06 >	•
450 FC	14 >	•
450 FE	14 >	•
450 FS	15 >	•
450 SMR	06 >	•
450 SMR R	06 >	•
501 FE	14 >	•
510 SM CENTENNIAL	06 >	•
510 SMR	06 >	•
510 TC 511	05 > 10	•
510 TE 511	06 > 10	•
510 TE 511	11 >	•
510 TE CENTENNIAL	04 >	•
511 SMR	11 >	•
630 SM	10 >	•

### KTM

125 EXC	04 >	•
125 EXC SIX DAYS	09 >	•
125 SX	04 >	•
144 SX	07 > 08	•
150 SX	09 >	•
200 EXC	04 >	•
200 SX	04 >	•
250 EXC	04 >	•
250 EXC F	06 >	•
250 EXC F SIX DAYS	09 >	•
250 EXC RACING	05 >	•
250 SX	03 >	•
250 SX-F	06 >	•
250 SXC	03 >	•

300 EXC	04 >	•
300 EXC SIX DAYS	09 >	•
300 SX	06 >	•
350 EXC F	11 >	•
350 EXC F SIX DAYS	11 >	•
350 SXF	11 >	•
400 EXC RACING	05 >	•
450 EXC	04 >	•
450 EXC R	05 > 06	•
450 EXC R	07 >	•
450 SM FACTORY REPLICAS	04 >	•
450 SMR	04 > 06	•
450 SMR	07 > 12	•
450 SMR	13 >	•
450 SX	04 >	•
450 SX RACING	05 >	•
450 SXF	07 >	•
450 XC-F	08 >	•
505 505 XC-F	09 >	•
505 SX-F	07 >	•
525 EXC	04 >	•
525 EXC RACING	05 >	•
525 SMR	04 > 04	•
525 SMR	05 >	•
525 SX	04 >	•
525 SX RACING	05 >	•
525 XC DESERT RACING	04 >	•
530 EXC	08 >	•
530 EXC R	09 >	•
560 SMR	06 >	•
660 SMC	04 > 05	•

### RIEJU

250 MRX MARATHON	10 >	•
450 MRX	08 >	•

**SHERCO**

250 I/R	12 >	•
250 SE R	14 >	•
250 SEF	14 >	•
250 SEI-F	14 >	•
250 SX 2.5	11 >	•
300 I/R	12 >	•
300 SE R	14 >	•

300 SEF	14 >	•
300 SEI-F	13 >	•
450 IR	12 >	•
450 SEF	14 >	•
510 IR	12 >	•

**SWM**

125 RS R	16 >	•
----------	------	---

125 SM R	16 >	•
250 MC S	16 >	•
300 RS R	15 >	• •
340 RS S	16 >	•
450 SM R	15 >	•
500 RS R	15 >	•



**07BB28.09** 94 x 36.2 x 8.6

**07BB28.SP** “ “ “

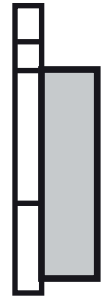
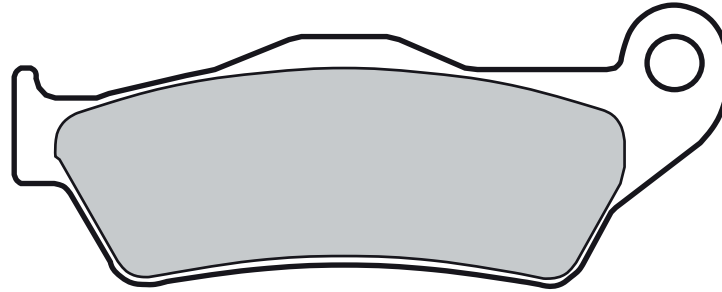

### BMW

850 R 850 C	99 >	•
850 R 850 GS	99 >	•
850 R 850 R	96 > 02	•
850 R 850 R	03 >	•
850 R 850 ROADSTER	96 > 02	•
850 R 850 RT	98 > 00	•
850 R 850 RT ABS	01 >	•
1100 R 1100 GS	94 >	•
1100 R 1100 R	95 > 98	•
1100 R 1100 R	99 >	•
1100 R 1100 RS	94 >	•
1100 R 1100 RT	95 >	•
1100 R 1100 S	99 > 00	•
1100 R 1100 S	01 >	•

1100 R 1100 S ABS	01 >	•
1150 R 1150 GS	00 > 01	•
1150 R 1150 GS	01 > 02	•
1150 R 1150 GS	03 > 05	•
1150 R 1150 GS ADVENTURE	01 > 02	•
1150 R 1150 GS ADVENTURE	03 > 05	•
1150 R 1150 R	01 >	•
1150 R 1150 R ROCKSTER	02 >	•
1150 R 1150 RS	01 >	•
1150 R 1150 RT	01 >	•
1150 R 1150 S	03 >	•
1200 HP2 MEGAMOTO	07 >	•
1200 K 1200 R	05 > 06	•
1200 K 1200 R	07 >	•
1200 K 1200 R SPORT	07 >	•
1200 K 1200 S	05 > 08	•

1200 K 1200 S ABS	05 > 08	•
1200 R 1200 C	98 > 02	•
1200 R 1200 C	03 >	•
1200 R 1200 GS	04 > 12	•
1200 R 1200 GS ABS	04 > 12	•
1200 R 1200 GS ADVENTURE	06 > 13	•
1200 R 1200 GS TRIPPLE BLACK	11 >	•
1200 R 1200 R	07 > 14	•
1200 R 1200 RT	05 >	•
1200 R 1200 S	06 >	•
1200 R 1200 ST	06 >	•
1300 K 1300 GT	09 >	•
1300 K 1300 R	09 >	•
1300 K 1300 R DYNAMIC	11 >	•
1300 K 1300 S	09 >	•



**07BB31.35**  
GENUINE

39.8 x 56.2 x 7.9

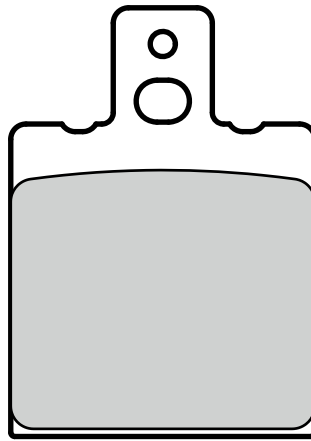

### ALFER

80	MC	87 >	•
125	MC	87 > 87	•
125	MC	88 >	•
250	GR ENDURO	85 > 87	•
250	GR ENDURO	88 >	•
250	MC	85 > 86	•
250	MC	87 > 87	•
250	MC	88 >	•
300	GR	85 >	•
300	GR ENDURO	88 >	•

### APRILIA

50	TUONO	04 >	•
125	CLASSIC	96 >	•
125	ETX	86 > 87	•
125	RED ROSE	89 > 89	•
125	RED ROSE	90 >	•
125	RS	99 > 05	•
125	RS PISTA	04 > 05	•
125	SPORT PRODUCTION	92 >	•
125	TUONO	04 >	•
200	CLIMBER	93 >	•
250	TUAREG RALLY	86 >	•
350	ETX	86 >	•
600	ETX	86 >	•
600	TUAREG	86 > 87	•
600	TUAREG WIND	88 > 89	•

### BENELLI

125	2C 4-STROKE	70 >	•
125	BX	89 >	•
125	CUSTOM	85 >	•
125	JARNO	89 >	•
350	354 TURISMO, SPORT	83 >	•
900	TORNADO 3	00 > 02	•

### BETA

50	KR TWIN	88 >	•
50	S02	97 >	•
50	TEMPO	97 > 98	•
250	GS	82 >	•
250	RV	82 >	•
260	ALP	96 >	•

500	GS	82 >	•
500	RV	82 >	•

### BIMOTA

500	V-DUE	97 >	•
650	BB1 SUPERMONO	97 >	•
750	SB7	94 >	•
900	DB4	99 >	•
900	MANTRA	97 >	•
1000	SB8 K SANTAMONICA	06 > 06	•
1000	SB8 K SANTAMONICA	07 >	•
1000	SB8 R	98 >	•
1000	YB 11	97 >	•
1100	SB6	97 >	•

### CAGIVA

50	PRIMA	92 > 92	•
50	SUPER CITY	92 > 92	•
80	SUPER CITY	92 > 93	•
80	SUPER CITY	94 >	•
125	BLUES	89 > 93	•
125	DAKAR	89 > 90	•
125	FRECCIA C10	88 > 89	•
125	FRECCIA C10 ANNIVERSARY	89 >	•
125	FRECCIA C12	89 >	•
125	FRECCIA C9	88 >	•
125	K 7	90 >	•
125	N1	96 >	•
125	SP MITO 525	08 >	•
125	SUPER CITY	92 >	•
200	ELEFANT	85 > 87	•
350	ALA AZZURRA	83 >	•
350	ALA BLU	83 >	•
350	ALA VERDE	83 >	•
350	W12	92 >	•
500	CROSS	80 >	•
750	LUCKY EXPLORER	88 >	•

### DB MOTORS

50	ZZ PIRAT	00 >	•
50	ZZ SPORT	00 >	•

### DERBI

125	MULHACEN	07 > 07	•
-----	----------	---------	---

### DUCATI

350	350 SUPERSPORT	92 >	•
350	F3	88 >	•
350	XL	82 >	•
400	400 SUPERSPORT	93 > 97	•
400	MONSTER 400	95 > 97	•
400	MONSTER 400 (MONODISCO)	05 >	•
400	MONSTER 400 DARK	03 >	•
500	502 SINGLE	93 >	•
500	502 SUPERMONO	93 >	•
600	600 SUPERSPORT	91 > 97	•
600	MONSTER 600	93 > 97	•
600	MONSTER 600	98 >	•
600	MONSTER 600	00 >	•
600	MONSTER 600 CITY	99 >	•
600	MONSTER 600 DARK	98 >	•
600	MONSTER 600 DARK	00 >	•
600	MONSTER 600 DARK CITY	99 >	•
600	MONSTER 600 DARK CITY	00 >	•
600	MONSTER 600 METALLIC	00 > 01	•
620	MONSTER 620 (BIDISCO)	05 >	•
620	MONSTER 620 DARK	03 >	•
620	MONSTER 620 DARK (MONODISCO)	04 >	•
620	MONSTER 620 DARK (MONODISCO)	05 >	•
620	MONSTER 620 I.E	02 >	•
620	MONSTER 620 I.E	03 >	•
620	MONSTER 620 I.E DARK	02 >	•
620	MONSTER 620 S I.E.	02 >	•
620	MONSTER 620 S I.E.	03 >	•
620	MONSTER 620, DARK	04 >	•
620	MULTISTRADA 620 (BIDISCO)	05 >	•
620	MULTISTRADA 620 DARK (MONODISCO)	05 >	•



650 SL	84 >	•
748 748 BIPOSTO	95 > 97	•
748 748 SP	95 > 97	•
750 750 SUPERSPORT	91 > 98	•
750 F1	86 >	•
750 INDIANA	89 >	•
750 MONSTER 750 (BIDISCO)	96 > 98	•
750 MONSTER 750 (MONODISCO)	96 > 97	•
750 MONSTER 750 CITY, DARK CITY	99 >	•
750 MONSTER 750 DARK	00 > 01	•
750 MONSTER 750 DARK I.E.	02 >	•
750 MONSTER 750 METALLIC	00 > 01	•
750 SPORT	74 > 76	•
803 MONSTER 800	04 >	•
803 MONSTER 800 S I.E.	03 >	•
803 MONSTER S2 R	05 >	•
803 MONSTER S2 R DARK	05 >	•
888 888 SP	92 >	•
888 888 SP4	92 >	•
888 888 SP5	93 >	•
888 SUPERBIKE STRADA	94 > 95	•
900 FE	97 >	•
900 MONSTER 900	93 > 99	•
900 MONSTER 900 CITY	99 >	•
900 MONSTER 900 CROMO	98 >	•
900 MONSTER 900 CROMO I.E.	00 >	•
900 MONSTER 900 CROMO I.E.	01 >	•
900 MONSTER 900 DARK CITY	99 >	•
900 MONSTER 900 DARK I.E.	01 >	•
900 MONSTER 900 DARK I.E.	02 >	•
900 MONSTER 900 I.E.	00 >	•
900 MONSTER 900 METALLIC I.E.	00 > 01	•
900 MONSTER 900 METALLIC I.E.	00 >	•
900 MONSTER 900 METALLIC I.E.	01 >	•
900 MONSTER 900 S I.E.	00 >	•
900 MONSTER 900 S I.E.	01 >	•
900 MONSTER 900 SPECIAL	98 >	•
900 SUPERLIGHT 900	92 > 97	•
907 907 I.E.	92 >	•
916 MONSTER S4	02 > 03	•
916 MONSTER S4 FOGGY	02 > 03	•
996 MONSTER S4 R	04 >	•
998 MONSTER S4 R TESTASTRETTA	07 >	•
998 MONSTER S4 RS TESTASTRETTA	06 >	•
1000 MONSTER 1000	04 > 05	•
1000 MONSTER 1000 S	05 >	•

1000 MONSTER 1000 S I.E.	03 >	•
1000 MONSTER S2 R 1000	06 >	•

### FANTIC MOTOR

250 COACH	91 >	•
-----------	------	---

### GARELLI

50 TIGER XLE	86 >	• •
50 URKA	91 >	•

### GILERA

50 SIOUX	92 >	• •
125 ARIZONA	83 >	•
125 CHRONO	91 >	•
125 CX	91 >	•
125 FAST BIKE	88 >	•
125 FREESTYLE	92 >	•
125 MX	83 >	•
125 MX1	88 >	•
125 R1	88 >	•
125 SP 01	89 >	•
125 SP 02	89 >	•
125 XR1	88 >	•
125 XR2	88 >	•
200 ARIZONA	85 >	•
200 FAST BIKE	88 >	•
200 RV	85 > 86	•
200 RV	86 >	•
250 MX LC	83 >	•
350 DAKOTA	89 >	•
350 XRT	89 >	•
500 DAKOTA	86 >	•
600 NORTHWEST	90 >	•
600 XRT	89 >	•

### HONDA

50 CRE	93 >	•
--------	------	---

### HRD

125 STRADA	83 >	• •
------------	------	-----

### HUSQVARNA

125 CX	84 > 85	•
400 ENDURO	85 >	•
430 ENDURO	85 >	•
500 CR	84 > 86	•
500 CX	84 > 85	•
500 TC	86 >	•
510 TE	86 >	•
540 504	83 >	•

### ITALJET

350 350	83 >	•
---------	------	---

### KTM

50 MX	91 >	•
80 MX	91 >	•
85 MX	90 >	•
125 MX	86 > 88	• •

### LAVERDA

50 ATLAS	86 >	• •
50 GAUCHO	92 >	• •
125 FL	82 >	•
650 FORMULA	94 > 95	•
650 GHOST	96 >	•
650 SPORT	94 > 95	•
650 STRADA	96 >	•
668 668	96 >	•
668 DIAMANTE	96 > 98	•
668 GHOST STRIKE LEGEND	96 > 98	•
750 CUP	98 >	•
750 DIAMANTE	97 >	•
750 GHOST STRIKE	97 >	•
750 S	97 > 98	•
750 S FORMULA	99 > 00	•
750 S SCARENATO	97 > 98	•
750 S SPORT	99 > 00	•
750 STRIKE BIFARO	98 > 99	•
750 STRIKE MONOFARO	98 > 99	•
750 T8	98 >	•

### MAICO

250 GM LC	85 >	•
-----------	------	---

### MALAGUTI

50 ENDURO	85 >	•
50 MRX	89 >	•
50 RST	89 >	• •

### MONTESA

260 EVASION	92 >	•
309 COTA	89 >	•
310 COTA	89 >	•
311 COTA TRIAL	92 >	•

### MOTO GUZZI

125 BX	92 >	• •
125 CUSTOM	85 >	•
125 ENDURO TT	85 >	•
250 TS	75 > 76	•
350 FALCO	88 >	• •
350 IMOLA	78 >	• •
350 NEVADA	92 >	• •
350 NTX	88 > 89	•
350 NTX	90 >	•
350 V 35 FLORIDA	87 >	•
400 400	77 >	• •
650 NTX	87 >	•
650 V 65	86 >	•
650 V 65 FLORIDA	87 >	•
650 V 65 LARIO	87 >	•
650 V 65 TT	84 >	• •
750 NEVADA	92 > 96	•
750 NEVADA	97 > 02	• •
750 NTX	89 > 89	•
750 TARGA	89 >	•
1000 V	93 >	•

### MOTO MORINI

250 COUNTRY	88 >	•
-------------	------	---



350	COGUARO	89 >	•
350	COGUARO NEW YORK	89 >	•
350	INDIANA	88 >	•
350	KANGURO	87 >	•
501	KANGURO	87 >	•
501	NEW YORK	89 >	•
650	INDIANA	88 >	•
750	INDIANA	88 >	•

**MZ**

660	SKORPION CUP MUZ	99 >	•
660	SKORPION REPLICA MUZ	97 >	•
660	SKORPION SPORT MUZ	95 > 99	•
660	SKORPION TOUR MUZ	95 > 99	•

660	SKORPION TRAVELLER MUZ	99 >	•
-----	------------------------	------	---

**OSSA**

500	YANQEE	78 >	•
-----	--------	------	---

**SACHS**

80	LOTUS SW	70 >	•
----	----------	------	---

**SIMSON**

50	HABICT	01 >	•
50	SPATZ	99 >	•
50	SPERBER	99 >	•
80	SR	70 >	•

**SWM**

125	GP	86 >	• •
125	S1-S2	70 >	•
250	EXPLORER	86 >	• •
250	PIONER	86 >	• •
250	S1-S2	70 >	•
329	TRL	86 >	•

**YAMAHA**

125	TDR R ITALIA	92 >	•
125	TZR R ITALIA	92 >	•
660	SZR	96 >	•





**07BB32.35**  
GENUINE

50.8 x 53.7 x 7.9

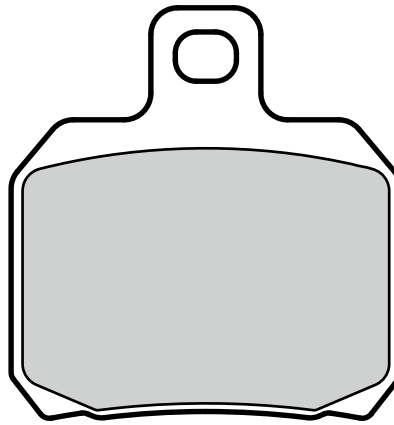

### BENELLI

899 TRE 899 K 09 > •

### BIMOTA

1000 DB5 05 > 06 •  
1000 DB5 07 > •  
1000 DB6 R DELIRIO 06 > •  
1098 DB7 08 > •  
1100 DB6 R DELIRIO 08 > •

### DERBI

50 GPR NUDE 04 > •  
50 GPR RACING 04 > •  
125 GP1 05 > •  
659 MULHACÉN 06 > •  
659 MULHACÉN CAFE' 08 > •

### DUCATI

620 SUPERSPORT 620 S 03 > •  
750 750 SUPERSPORT 99 > •  
750 750 SUPERSPORT I.E. 00 > 02 •  
750 750 SUPERSPORT S I.E. 02 > •  
750 SPORT 00 > •  
803 SUPERSPORT 800 06 > •



803 SUPERSPORT 800 S 03 > •  
803 SUPERSPORT 800 SS 03 > •  
900 SPORT TOURING 4 99 > •  
900 SUPERSPORT 900 98 > 99 •  
900 SUPERSPORT 900 I.E. 00 > 02 •  
900 SUPERSPORT 900 S I.E. 02 > •  
916 ST4 99 > 99 •  
916 ST4 00 > 03 •  
916 ST4 S 03 > 04 •  
916 ST4 S ABS 03 > 04 •  
944 SPORT TOURING 2 99 > 00 •  
992 ST3 04 > •  
992 ST3 ABS, ST3 S ABS 07 > •  
992 ST4, ST4 ABS 05 > •  
992 SUPERSPORT 1000 06 > •  
992 SUPERSPORT 1000 DS 05 > •  
992 SUPERSPORT 1000 S 03 > •

### LAVERDA

800 TTS 99 > •

### MONDIAL

1000 STARFIGHTER 04 > •



### MOTO GUZZI

750 BREVA 750 I.E. 03 > 06 •  
750 NEVADA 03 > •  
750 NEVADA CLASSIC I.E. 06 > •  
750 V7 II RACER 15 > •  
750 V7 II STORNELLO 16 > •  
850 V9 BOBBER 16 > •  
850 V9 CUSTOM ROAMER 16 > •  
1200 MGS-01 CORSA 05 > •

### RIEJU

50 SMX PRO 08 > •  
50 TANGO 10 > •  
125 MARATHON PRO 09 > •  
125 MARATHON PRO SUPERMOTARD 09 > •  
125 TANGO 08 > •  
125 TANGO PRO 08 > •  
250 TANGO 08 > •

### VOXAN

1000 CAFE' RACER 01 > •  
1000 EVO 04 > •  
1000 ROADSTER 01 > •



**07BB33.96**  
GENUINE 34.9 x 40.5 x 7.9

**07BB33.SA** 34.9 x 40.5 x 8

**07BB33.SC** 34.9 x 40.5 x 8.7

**07BB33.RC** “ “ “

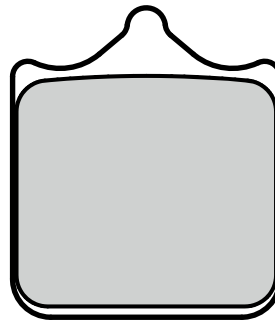

### APRILIA

1000 RSV	02 >	•
1000 RSV FACTORY	03 >	•
1000 RSV NERA	04 >	•
1000 RSV R	01 >	•
1000 TUONO R	03 >	•
1000 TUONO RACING	04 >	•

### BENELLI

449 BX SUPERMOTARD	08 >	•
600 BN	14 >	•
899 TNT CENTURY RACER	11 >	•
900 TORNADO 3	03 >	•
1130 TNT CAFE' RACER	05 >	•
1130 TNT CENTURY RACER	11 >	•
1130 TNT OFFICINE	07 >	•
1130 TNT R 160	10 >	•
1130 TNT SPORT	05 >	•
1130 TNT TITANIUM	05 >	•
1130 TORNADO TRE	06 >	•
1130 TORNADO TRE R	13 >	•
1130 TRE K AMAZONAS	13 >	•

### BIMOTA

1000 DB5	05 > 06	•
1000 DB5	07 >	•
1000 DB6 R DELIRIO	06 >	•
1000 SB8 K SANTAMONICA	07 >	•
1078 DB10 BIMOTARD	12 >	•
1078 DB5	12 >	•
1098 DB7	08 >	•
1100 DB6 R DELIRIO	08 >	•
1100 TESI 3D	07 >	•
1200 DB12	12 >	•
1200 DB9 BRIVIDO	12 >	•

### BMW

450 G 450 SMR	09 >	•
1000 S 1000 R	13 >	•
1000 S 1000 R ABS	14 >	•
1000 S 1000 RR	09 >	•

### CAGIVA

1000 X-RAPTOR	03 >	•
---------------	------	---

### DERBI

659 MULHACÉN	06 >	•
659 MULHACÉN CAFE'	08 >	•

### DUCATI

748 748 R	01 > 02	•
748 749	03 > 07	•
748 749 DARK	05 > 06	•
748 749 R	03 > 07	•
748 749 S	03 > 07	•
996 996 R	01 >	•
998 998 F.E.	04 >	•
998 998 R	02 >	•
998 998 S	02 >	•
998 999	03 > 07	•
998 999 R	03 > 07	•
998 999 S	03 > 07	•
998 MONSTER S4 R	07 >	•
998 TESTASTRETTA	07 >	•
998 MONSTER S4 RS	06 >	•
998 TESTASTRETTA	06 >	•
999 999 XEROX	06 >	•

### HUSQVARNA

250 SMR	06 >	•
449 SMR	11 >	•
450 SMR	05 >	•
450 SMR	06 >	•
450 SMR R	06 >	•
510 SM CENTENNIAL	06 >	•
510 SMR	05 > 05	•
510 SMR	06 >	•
511 SMR	11 >	•
610 SM	05 >	•
610 SMS	06 >	•
630 SMS	10 >	•
701 SUPERMOTO	15 >	•

### HYOSUNG

450 RX SM	08 >	•
-----------	------	---

### KTM

690 DUKE	08 > 11	•
690 DUKE R	10 > 11	•
690 SM PRESTIGE	07 >	•
690 SMC	08 >	•
690 SMC R	14 >	•
950 DUKE	03 >	•
950 SUPERMOTO	05 >	•
950 SUPERMOTO R	07 >	•
990 SUPER DUKE	05 > 05	•
990 SUPER DUKE	06 >	•
990 SUPERDUKE R	07 >	•
990 SUPERDUKE R	09 >	•
990 SUPERMOTO	06 >	•
990 SUPERMOTO	09 >	•
990 SUPERMOTO T	09 >	•

### LAVERDA

1000 SFC (LIMITED EDITION)	03 >	•
----------------------------	------	---

### MONDIAL

1000 PIEGA	02 >	•
1000 PIEGA EVO	04 >	•
1000 PIEGA RZ NUDA	04 >	•
1000 STARFIGHTER	04 >	•

### MOTO GUZZI

750 GRISO	04 >	•
1200 MGS-01 CORSA	05 >	•

### MOTO MORINI

1200 GRANFERRO	10 >	•
----------------	------	---

### MV AGUSTA

910 BRUTALE R	06 >	•
1000 F4 312 R	07 >	•
1000 F4 R	06 >	•
1000 F4 R 1+1	06 >	•
1000 F4 SENNA	06 >	•

### NORTON

961 COMMANDO CAFE' RACER	11 >	•
--------------------------	------	---



961 COMMANDO SE  
961 COMMANDO SF



12 > •  
13 > •

**TM**

660 SMX F 05 > •



1050 SPEED TRIPLE (SPECIAL EDITION) 09 > •

1050 SPEED TRIPLE ABS 11 > 12 •

1050 SPEED TRIPLE S ABS 08 > 08 •

1050 SPEED TRIPLE S ABS 09 > 10 •

**SHERCO**

450 4.5 I SUPERMOTARD 06 > •

**TRIUMPH**

800 TIGER XC ABS 12 > •

1050 SPEED 94 15 > •

1050 SPEED TRIPLE 08 > 13 •

**SWM**

450 SM R 15 > •

600 SUPERDUAL 15 > •



**07BB34.29**  
GENUINE

67.8 x 56.5 x 12

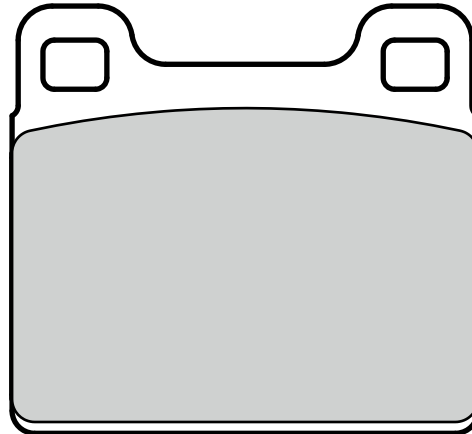

**BOMBARDIER-CAN AM**

400	LYNX ENDURO RC	05 >	•
400	SKI-DOO MX Z X LC	98 > 99	•
440	LYNX RAVE	05 >	•
440	LYNX RAVE RC	07 >	•
440	SKI-DOO MX Z RACING	06 >	•
440	SKI-DOO MX Z X	02 > 03	•
440	SKI-DOO MX Z X LC	97 >	•
440	SKI-DOO MX Z X LC	00 > 01	•
440	SKI-DOO MX Z X RACING	04 >	•
453	LYNX RAVE RC	06 >	•
500	LYNX ENDURO RC	04 >	•
500	LYNX ENDURO SPECIAL/ RER	02 >	•
500	LYNX SUPER TOURING	02 >	•
500	SKI-DOO GRAND TOURING	02 >	•
500	SKI-DOO GSX SS	04 >	•
500	SKI-DOO LEGEND SS	04 >	•
500	SKI-DOO MX Z	01 >	•
500	SKI-DOO MX Z SS TRAIL & ADRENALINE	04 >	•
500	SKI-DOO SKANDIC	02 >	•
500	SKI-DOO SKANDIC SUPER WIDE TRACK F	03 >	•
500	SKI-DOO SKANDIC WIDE TRACK F	03 >	•
550	LYNX ENDURO	05 >	•
550	LYNX ENDURO RC	05 >	•
550	LYNX RANGER	05 >	•
550	LYNX RAVE N-DURO F	06 >	•
550	LYNX ST	05 >	•
550	LYNX ST F	04 >	•
550	LYNX YETI	08 >	•
550	LYNX YETI PRO	08 >	•
550	LYNX YETI SUV	09 >	•

550	SKI-DOO SKANDIC SUV F	04 >	•
550	SKI-DOO SKANDIC SWT	04 >	•
550	SKI-DOO SKANDIC WT F	04 >	•
600	LYNX YETI	08 >	•
600	LYNX ENDURO HO	04 >	•
600	LYNX ENDURO HO SDI	05 >	•
600	LYNX ENDURO RC	04 >	•
600	LYNX ENDURO RER	02 >	•
600	LYNX ENDURO SPECIAL	02 >	•
600	LYNX ENDURO SPECIAL	03 >	•
600	LYNX RANGER	04 >	•
600	LYNX RANGER LCE	03 >	•
600	LYNX RAVE HO SDI	08 >	•
600	LYNX RAVE N-DURO	06 >	•
600	LYNX RAVE RC HO SDI	06 >	•
600	LYNX RAVE RE	08 >	•
600	LYNX RAVE RE HO	07 >	•
600	LYNX RAVE XT N-DURO HO SDI	07 >	•
600	LYNX SPORT TOURING	03 >	•
600	LYNX SPORT TOURING HO SDI	05 >	•
600	LYNX ST	04 >	•
600	LYNX SUPER TOURING	02 >	•
600	LYNX XTRIM N-DURO HO SDI	06 >	•
600	LYNX XTRIM SDI	08 >	•
600	LYNX YETI SDI	06 >	•
600	LYNX YETI TUV HO SDI	07 >	•
600	SKI-DOO EXPEDITION HO SDI	05 >	•
600	SKI-DOO EXPEDITION TUV HO SDI	07 >	•
600	SKI-DOO GRAND TOURING	02 >	•
600	SKI-DOO GSX HO	04 >	•

600	SKI-DOO LEGEND HO SDI	04 >	•
600	SKI-DOO MX Z	99 >	•
600	SKI-DOO MX Z	07 >	•
600	BLIZZARD HO SDI	07 >	•
600	SKI-DOO MX Z HO	03 >	•
600	SKI-DOO MX Z HO ADRENALINE	06 >	•
600	SKI-DOO MX Z HO RENEGADE	04 >	•
600	SKI-DOO MX Z HO RENEGADE X	04 >	•
600	SKI-DOO MX Z HO SDI	04 >	•
600	SKI-DOO MX Z HO SDI ADRENALINE & X	05 >	•
600	SKI-DOO MX Z HO SDI RENEGADE	05 >	•
600	SKI-DOO MX Z HO SDI RENEGADE X	05 >	•
600	SKI-DOO MX Z HO SDI RENEGADE, EARLY INTRO	05 >	•
600	SKI-DOO MX Z HO TRAIL & ADRENALINE & X	04 >	•
600	SKI-DOO MX Z RENEGADE X HO SDI	07 >	•
600	SKI-DOO MX Z REV HO 007 SPECIAL EDITION	03 >	•
600	SKI-DOO MX Z X HO SDI	07 >	•
600	SKI-DOO MX Z XRS HO SDI	07 >	•
600	SKI-DOO SKANDIC	02 >	•
600	SKI-DOO SKANDIC SUV	03 >	•
600	SKI-DOO SKANDIC SUV	04 >	•
600	SKI-DOO SKANDIC SUV HO SDI	08 >	•



600	SKI-DOO SKANDIC WT	05 >	•
600	SKI-DOO SKANDIC WTLC	04 >	•
600	SKI-DOO SUMMIT	02 >	•
600	SKI-DOO SUMMIT HO	03 >	•
600	SKI-DOO SUMMIT HO SDI ADRENALINE	06 >	•
700	LYNX ENDURO RER	02 >	•
700	LYNX ENDURO SPECIAL	02 >	•
700	LYNX SUPER TOURING	02 >	•
700	SKI-DOO GRAND TOURING	02 >	•
700	SKI-DOO LEGEND	04 >	•
700	SKI-DOO MX Z	01 >	•
700	SKI-DOO SUMMIT	02 >	•
700	SKI-DOO SUMMIT HO	03 >	•
800	LYNX ADVENTURE HO	05 >	•
800	LYNX MOUNTAIN HO	04 >	•
800	LYNX RAVE	05 >	•
800	LYNX RAVE CROSS HO	04 >	•
800	LYNX RAVE RC	04 >	•
800	LYNX RAVE RC HO POWER TEK	07 >	•
800	LYNX RAVE RC PT	06 >	•
800	LYNX RAVE SPECIAL	02 >	•
800	LYNX RAVE XT N-DURO HO POWER T	07 >	•
800	LYNX RAVE XTRIM N-DURO POWER TEK	06 >	•
800	LYNX SPORT TOURING	03 >	•
800	LYNX SUPER TOURING	02 >	•
800	LYNX YETI PRO ARMY V	09 >	•

800	LYNX YETI PRO V	07 >	•
800	LYNX YETI SUV V	07 >	•
800	LYNX YETI V	08 >	•
800	SKI-DOO EXPEDITION TUV V	07 > 08	•
800	SKI-DOO EXPEDITION TUV V 4-TEC	09 >	•
800	SKI-DOO GRAND TOURING	02 >	•
800	SKI-DOO GRAND TOURING SE SDI	03 >	•
800	SKI-DOO GSX HO	04 >	•
800	SKI-DOO GTX	05 >	•
800	SKI-DOO LEGEND SDI	04 >	•
800	SKI-DOO LEGEND SE SDI	03 >	•
800	SKI-DOO MX Z	01 >	•
800	SKI-DOO MX Z BLIZZARD HO PTEK	07 >	•
800	SKI-DOO MX Z HO ADRENALINE & X	04 >	•
800	SKI-DOO MX Z HO RENEGADE	05 >	•
800	SKI-DOO MX Z HO RENEGADE X	04 >	•
800	SKI-DOO MX Z RENEGADE X HO PTEK	07 >	•
800	SKI-DOO MX Z REV	02 >	•
800	SKI-DOO MX Z REV HO 007 SPECIAL EDITION	03 >	•
800	SKI-DOO MX Z X HO PTEK	07 >	•

800	SKI-DOO MX Z XRS HO PTEK	07 >	•
800	SKI-DOO SKANDIC SWT V	07 >	•
800	SKI-DOO SUMMIT	02 >	•
800	SKI-DOO SUMMIT HO	03 >	•
800	SKI-DOO SUMMIT HO ADRENALINE & X	06 >	•
800	SLI-DOO SUMMIT X HO	03 >	•
1000	LYMX RANGER V	03 >	•
1000	LYNX TOURING V	05 >	•
1000	SKI-DOO EXPEDITION V	05 >	•
1000	SKI-DOO MACH Z SDI	05 >	•
1000	SKI-DOO MACH Z SDI ADRENALINE & X	06 >	•
1000	SKI-DOO MX Z SDI RENEGADE RT	07 >	•
1000	SKI-DOO MX Z SDI RENEGADE X	06 >	•
1000	SKI-DOO SUMMIT SDI HIGHMARK	05 >	•
1000	SKI-DOO SUMMIT SDI HIGHMARK X	05 >	•
1300	LYNX EXPEDITION TUV V	06 >	•
1300	LYNX YETI TUV V	06 >	•
1300	LYNX YETI V	08 >	•
1300	SKI-DOO EXPEDITION TUV (EUROPE)	07 >	•
1300	SKI-DOO EXPEDITION V	08 >	•



**07BB35.90**  
GENUINE

86 x 43.5 x 10

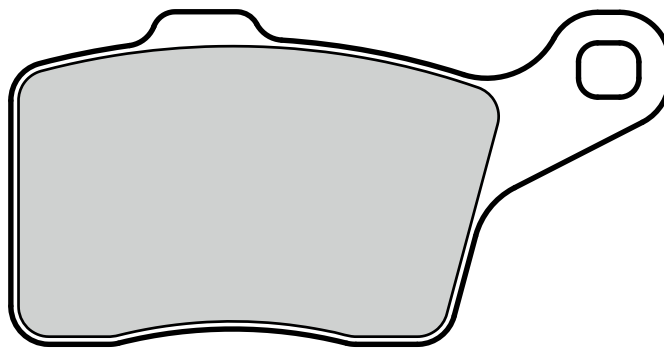
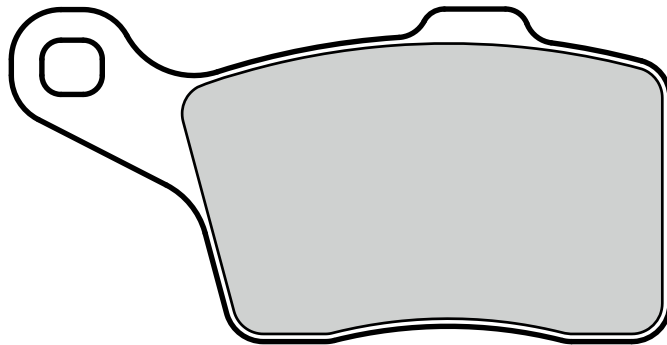

**BOMBARDIER-CAN AM**

600	LYNX ADVENTURE GRAND TOURER SDI	09 >	•
600	LYNX ADVENTURE GT GT SDI	10 >	•
600	LYNX RAVE	09 >	•
600	LYNX RAVE RE E-TEC	09 >	•
600	LYNX RAVE RS LYNX XTRIM	08 >	•
600	COMMANDER LIMITED SDI	70 >	•
600	LYNX XTRIM COMMANDER SDI	70 >	•

600	LYNX XTRIM SC E-TEC	70 >	•
600	SKI-DOO EXPEDITION SE HOETEC XU	11 >	•
600	SKI-DOO EXPEDITION TUV H.O. SDI REV-XU	09 >	•
600	SKI-DOO EXPEDITION TUV H.O. SDI XU	10 >	•
600	SKI-DOO EXPEDITION TUV SE HO SDI XU	10 >	•
600	SKI-DOO MX Z RS	08 >	•
600	SKI-DOO SKANDIC WT ACE XU	11 >	•

600	SKI-DOO SKANDIC WT HO ETEC	11 >	•
800	LYNX RAVE POWER TEK	09 >	•
800	LYNX XTRIM SC POWER TEK	70 >	•
1200	LYNX ADVENTURE GT	10 >	•
1200	SKI-DOO EXPEDITION SE XU	11 >	•
1200	SKI-DOO EXPEDITION TUV REV-XU	10 >	•
1200	SKI-DOO EXPEDITION TUV SE REV-XU	10 >	•



**07BB36.35**  
GENUINE

75.1 x 55.5 x 7

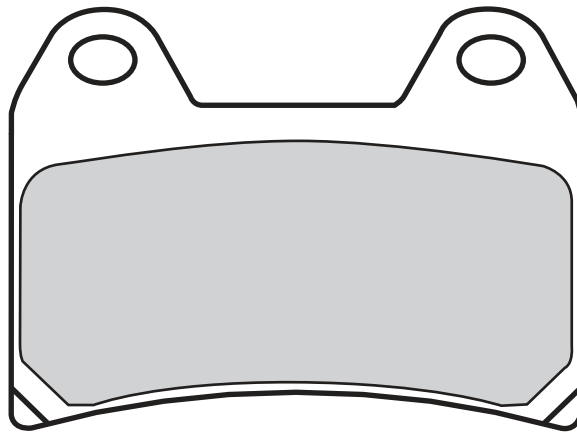

### DUCATI

659	MONSTER 659	12 > 13	•
659	MONSTER 659 ABS	12 > 14	•
696	MONSTER 696	08 >	•
696	MONSTER 696 /	09 >	•
696	MONSTER 696 +	10 > 14	•
696	MONSTER 696 ABS	13 >	•
696	MONSTER 696 ANNIVERSARY / ABS		

795	MONSTER 795	12 > 14	•
795	MONSTER 795 ABS	13 > 15	•
795	MONSTER 795 ABS CORSE STRIPE	14 >	•
796	HYPERMOTARD	10 >	•
796	MONSTER	11 >	•
796	MONSTER 796	11 >	•
796	MONSTER 796 ABS	11 >	•
796	MONSTER 796 ABS ANNIVERSARY	13 >	•

796	MONSTER 796 ANNIVERSARY	13 >	•
796	MONSTER ABS	11 >	•
796	MONSTER ABS ANNIVERSARY	13 >	•
796	MONSTER ANNIVERSARY	13 >	•
803	SUPERSPORT 800 SS	03 >	•



**07BB37.93**  
GENUINE 102.2 x 42 x 7.7

**07BB37.SA** “ “ “

**07BB37.SC** “ “ “

**07BB37.RC** “ “ “

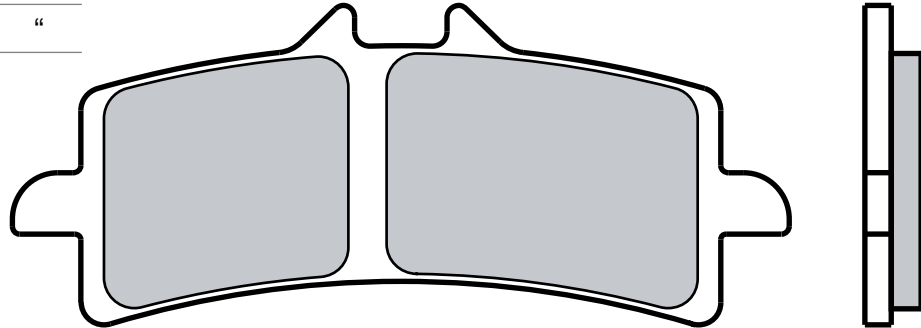

### APRILIA

1000 RSV 4RF	15 >	•
1000 RSV 4RR	15 >	•
1000 RSV4 FACTORY	09 >	•
1000 RSV4 FACTORY APRC	11 > 12	•
1000 RSV4 FACTORY APRC ABS	13 >	•
1000 RSV4 R	10 >	•
1000 RSV4 R APRC ABS	14 >	•

### BIMOTA

800 TESI 3D RACECAFE'	16 >	•
1000 BB3	13 >	•
1078 TESI 3D NAKED	16 >	•
1098 DB7	09 >	•
1198 DB8	10 >	•
1198 IMPETO	16 >	•
1200 DB11 VLX (RED CALL)	13 >	•

### BMW

1000 S 1000 RR HP4	12 > 14	•
1200 HP2 SPORT	08 >	•

### DUCATI

848 848 EVO	11 >	•
990 DESMOSEDICI RR (D16RR)	07 >	•
1098 1098 R BAYLISS	09 >	•
1098 STREETFIGHTER	09 >	•
1098 STREETFIGHTER S	09 >	•
1099 1098	07 >	•
1099 1098 S	07 >	•
1099 1098 TRICOLORE	07 >	•
1100 HYPERMOTARD EVO SP	10 >	•
1100 HYPERMOTARD S	07 >	•
1198 1098 BAYLISS	09 >	•
1198 1098 R	08 >	•
1198 1198	09 >	•
1198 1198 S	09 >	•

1198 1198 SP	11 >	•
1199 PANIGALE	12 >	•
1199 PANIGALE R	13 >	•
1199 PANIGALE S	12 >	•
1199 SUPERLEGGERA	14 >	•
1200 DIAVEL	11 >	•
1200 DIAVEL CARBON	14 >	•
1200 DIAVEL DARK	14 >	•
1200 DIAVEL STRADA	13 >	•
1200 DIAVEL TITANIUM	15 >	•
1200 MONSTER R	15 >	•
1200 MONSTER S	14 >	•
1200 MONSTER S STRIPE	15 >	•
1200 MULTISTRADA S	15 >	•
1200 MULTISTRADA S D-AIR	15 >	•
1200 MULTISTRADA S PIKES PEAK	15 >	•
1200 MULTISTRADA TOURING S ABS	15 > 16	•
1262 X DIAVEL S	16 >	•
1299 PANIGALE	15 >	•
1299 PANIGALE R	15 >	•
1299 PANIGALE S	15 >	•

### ENERGICA

11.7 EGO	15 >	•
11.7 EVA	15 >	•

### HONDA

1000 CBR RR SP	14 >	•
1000 RCV213V	15 >	•

### HUSQVARNA

450 FS	15 >	•
900 NUDA R	12 >	•

### KAWASAKI

1000 H2	15 >	•
1000 H2 R	15 >	•

1000 ZX 10 R	16 >	•
1000 ZX 10 R WINTER EDITION	16 >	•
1400 ZZR ABS	16 >	•

### KTM

450 SMR	13 >	•
690 DUKE R	14 >	•
990 LC8 990 SUPERMOTO R	09 >	•
1190 RC8	08 >	•
1190 RC8	09 >	•
1190 RC8 R	09 >	•
1190 RC8 R TRACK	11 >	•
1290 SUPER DUKE GT	16 >	•
1290 SUPER DUKE R	14 >	•

### MV AGUSTA

675 F3	15 >	•
675 F3 RC	16 >	•
800 F3	13 >	•
800 F3 AMG GT	16 >	•
800 F3 RC	16 >	•
1000 F4 R CORSA CORTA	12 >	•
1000 F4 RR	11 >	•
1000 F4 RR CORSA CORTA	12 >	•
1078 BRUTALE RR	08 >	•
1078 BRUTALE RR	09 >	•
1078 F4 312 RR	08 >	•
1078 F4 CC	08 >	•
1090 BRUTALE	13 >	•
1090 BRUTALE CORSA	14 >	•
1090 BRUTALE RR	10 > 11	•
1090 BRUTALE RR	12 >	•

### SUZUKI

600 GSX-R	11 >	•
750 GSX-R	11 >	•
1000 GSX R	12 >	•
1000 GSX R ABS	15 >	•





1000 GSX S 1000 F ABS	15 >	•
1000 GSX S ABS	15 >	•
1300 GSX R HAYABUSA (RED CALL)	13 >	•

### TRIUMPH

675 DAYTONA R	13 >	•
675 DAYTONA R TRIPLE	11 > 12	•
675 DAYTONA R TRIPLE	13 >	•
1050 SPEED 94R	15 >	•



1050 SPEED TRIPLE R	12 >	•
1050 SPEED TRIPLE R ABS	12 >	•
1050 SPEED TRIPLE S	16 >	•
1200 THRUXTON R	16 >	•





**07BB38.84**  
GENUINE 85 x 50.8 x 8

**07BB38.SA** “ “ “

**07BB38.SC** “ “ “

**07BB38.RC** “ “ “

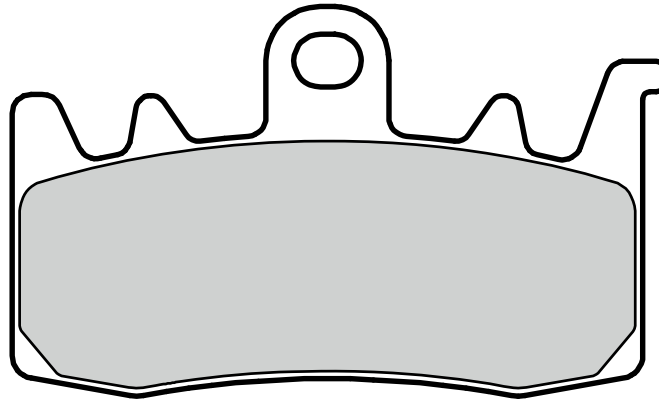

### APRILIA

1000 TUONO	13 >	•
1000 TUONO V4R APRC ABS	14 >	•
1100 TUONO V4 FACTORY	15 >	•
1100 TUONO V4 FACTORY RR	15 >	•
1200 CAPONORD	13 >	•
1200 CAPONORD ABS	14 >	•
1200 CAPONORD RALLY	15 >	•
1200 CAPONORD TP	14 >	•

### BENELLI

300 BN 302 TORNADO	16 >	•
600 BN GT	14 >	•
600 BN R	15 >	•

### BMW

313 G 310 R	16 >	•
800 F 800 R	15 >	•
1000 S 1000 XR	15 >	•
1200 R 1200 GS	13 >	•
1200 R 1200 GS ADVENTURE	14 >	•
1200 R 1200 R	15 >	•
1200 R 1200 RS	15 >	•

1200 R 1200 RT

14 > •

1200 R NINE T

14 > •

### DUCATI

803 HYPERMOTARD	13 >	•
803 HYPERMOTARD SP	13 >	•
803 HYPERSTRADA	13 >	•
803 SCRAMBLER CLASSIC	15 >	•
803 SCRAMBLER FLAT TRACK PRO	16 >	•
803 SCRAMBLER FULL THROTTLE	15 >	•
803 SCRAMBLER ICON	15 >	•
803 SCRAMBLER ITALIAN INDEPENDENT	16 >	•
803 SCRAMBLER URBAN ENDURO	15 >	•
821 HYPERMOTARD SP	15 >	•
821 MONSTER 821	15 >	•
821 MONSTER 821 DARK	15 >	•
821 MONSTER 821 STRIPE	15 >	•
899 PANIGALE	14 >	•
939 HYPERMOTARD	16 >	•
939 HYPERMOTARD SP	16 >	•

939 HYPERSTRADA

16 > •

959 PANIGALE

16 > •

1200 MONSTER

14 > •

1200 MULTISTRADA

15 > •

1200 MULTISTRADA ENDURO

16 > •

1200 MULTISTRADA TOURING

15 > 16 •

ABS

1262 XDIAVEL

16 > •

### MV AGUSTA

800 RIVALE	13 >	•
800 STRADALE	15 >	•
800 TURISMO VELOCE	14 >	•
800 TURISMO VELOCE LUSSO	14 >	•

### TRIUMPH

1215 TIGER EXPLORER XC	16 >	•
1215 TIGER EXPLORER XCa	16 >	•
1215 TIGER EXPLORER XCx	16 >	•
1215 TIGER EXPLORER XR	16 >	•
1215 TIGER EXPLORER XRt	16 >	•
1215 TIGER EXPLORER XRx	16 >	•



**07BB39.9A**  
GENUINE 96.3 x 43.4 x 8.70

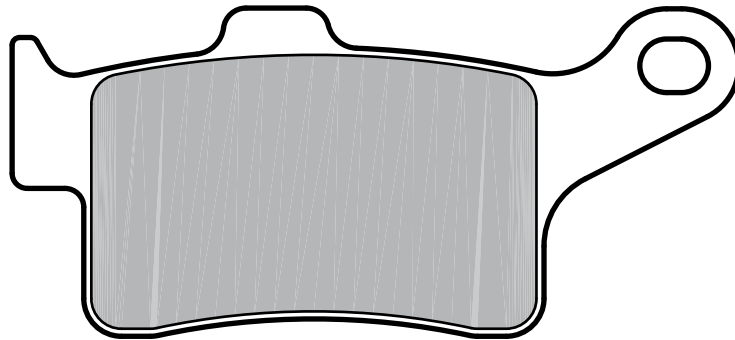
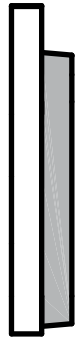
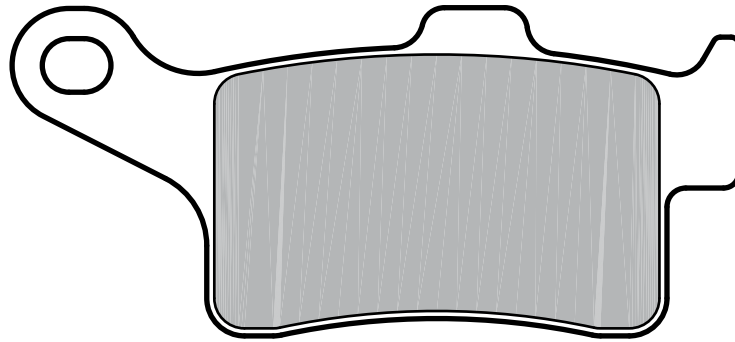

**BOMBARDIER-CAN AM**

998	SPYDER SPORT	16 >	•
998	SPYDER SPORT TOURING	16 >	•
1330	SPYDER SPORT CRUISING	16 >	•
1330	SPYDER TOURING	16 >	•



**07GR01.01** 31.2 x 49 x 5.6

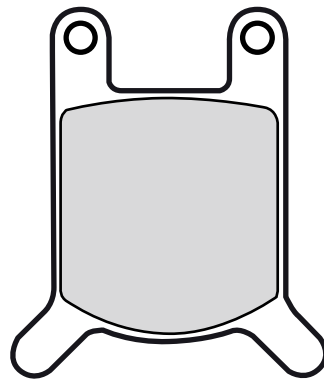

### BENELLI

250 254	83 >	•
---------	------	---

### BETA

50 MG	83 >	•
50 SQUIRREL	83 >	•

### CASAL

50 RZ	70 >	•
-------	------	---

### FANTIC MOTOR

50 SUPER SIX	83 >	•
--------------	------	---

### GARELLI

40 S SPORT	70 >	•
80 SPORT	83 >	•

### HERCULES

50 RS	79 > 83	•
50 ULTRA	79 > 83	•
80 AC CHOP	81 > 83	•
80 CHOPPER	81 >	•
80 RX 9	82 > 83	•

80 RX 9 AIR COOLED	82 > 83	•
80 ULTRA	81 >	•
80 ULTRA CHOPPER AC	81 > 83	•

### HOREX

80 REBELL N	70 >	•
80 REBELL T	86 >	•
80 SPORT L	86 >	•

### MALAGUTI

25 CHOPPER	86 >	•
40 CHOPPER	83 >	•
50 FIFTY HF WC	83 >	•
50 RONCO	83 >	•
50 SPORT XL	83 >	•
50 V4 OLIPIQUE	83 >	•
80 CHOPPER	83 >	•
125 RUNNER	86 > 86	•

### MOTO GUZZI

125 T	81 >	•
-------	------	---

### OSSA

350 TU-YO	70 >	•
-----------	------	---

### PUCH

50 COBRA 6 GT, GTL	80 >	•
50 MONZA 4 SL, GSL	80 >	•

### RIEJU

80 NEVADA SPORT	70 >	•
-----------------	------	---

### SACHS

80 LOTUS SA	70 >	•
-------------	------	---

### ZÜNDAPP

50 KS SUPER SPORT	79 >	•
50 KS TT	80 > 81	•
80 KS SUPER	83 >	•
80 KS TOURING	80 >	•
175 KS	78 > 80	•

### ZWEIRAD RÖTH

50 REBEL SPORT	70 >	•
80 REBEL SPORT	70 >	•

**07GR02.04**

49 x 58 x 7.1

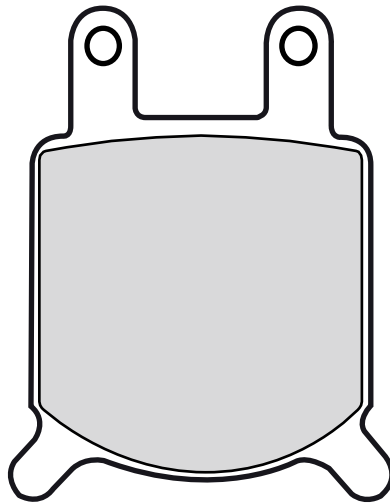
**ASPES**

125 JUMA	76 >	•
----------	------	---

**BETA**

125 CUSTOM	83 >	•
125 TS	83 >	•
250 CUSTOM	82 >	•

**FANTIC MOTOR**

125 SPORT HP1	86 >	•
---------------	------	---

**GARELLI**

125 GTA	86 >	•
125 TSR	83 >	•

**GILERA**

80 TG1	83 >	•
125 GR1	85 >	•
125 RV	86 >	•
125 TG1	85 >	•
200 RV	86 >	•
200 T4	85 >	•
200 T4C	85 >	•
200 T4S	85 >	•

**KREIDLER**

125 MUSTANG	83 >	•
-------------	------	---

**LAVERDA**

125 125	80 >	83 •
---------	------	------

**MOTO MORINI**

125 STRADA	70 >	•
250 STRADA	70 >	•
250 TT	86 >	•
350 K2	84 >	•
350 SPORT	80 >	• •
350 STRADA	70 >	•
350 TT	80 >	•
500 STRADA	70 >	•
500 TT	80 >	•

**ZÜNDAPP**

80 KS	80 >	•
125 KS	79 >	81 •



**07GR03.CC** 98.1 x 32.6 x 7.6  
110.8 x 35.7 x 7.6

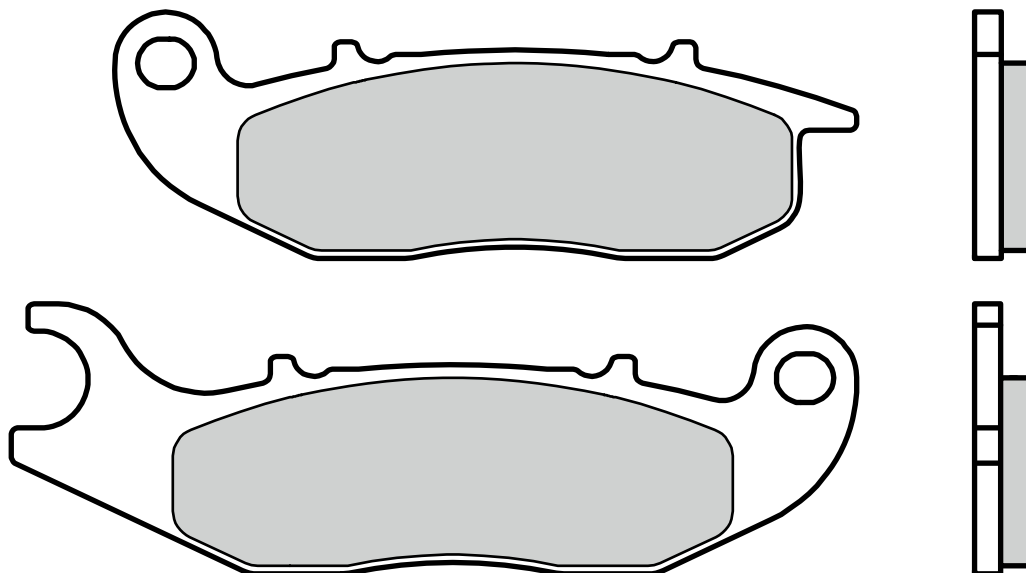

### DERBI

50	SENDA DRD EVO SM	09 >	•
50	SENDA DRD PRO R/SM	09 >	•
50	SENDA DRD RACING R/SM	09 >	•
125	CROSS CITY	09 >	•
125	MULHACEN	08 >	•
125	SENDA BAJA R/SM	09 >	•

125	SENDA DRD R/SM	09 >	•
125	TERRA	08 >	•
125	TERRA ADVENTURE	08 >	•

### HM

125	CRE BAJA	11 >	•
-----	----------	------	---

### HONDA

250	CRF L	14 >	•
-----	-------	------	---

### RIEJU

50	MRT	11 >	•
----	-----	------	---

### SCORPA

250	T-RIDE	08 >	•
-----	--------	------	---



**07GR05.CC** 65.7 x 36.7 x 7.4

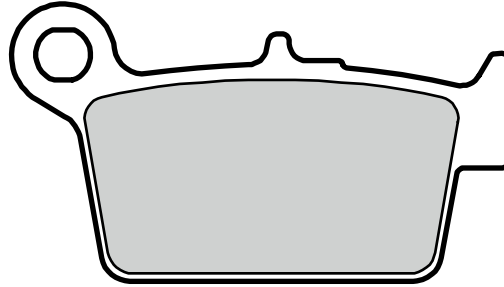
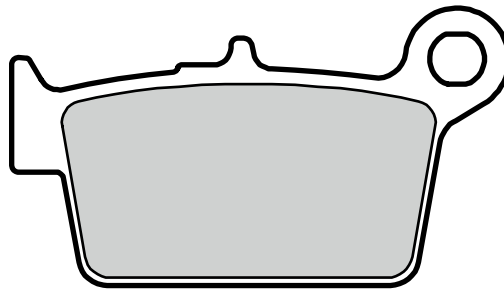

**BETA**

50	RR ENDURO	10 >	•
50	RR SUPERMOTARD	08 >	•
125	ALP 4-STROKE (EBE)	06 >	•



125	ENDURO	10 >	•
125	M4 (EBE)	06 >	•
125	RR ENDURO	10 >	•
125	RR SUPERMOTARD	08 >	•
125	URBAN	10 >	•



200	ALP 4-STROKE (EBE)	06 >	•
200	URBAN	10 >	•
350	ALP 4.0 (EBE)	06 >	•
350	M4	06 >	•
350	M4 (EBE)	06 >	•



**07GR06.SA** 78.1 x 46.2 x 7.8

**07GR06.SC** “ “ “

**07GR06.RC** “ “ “

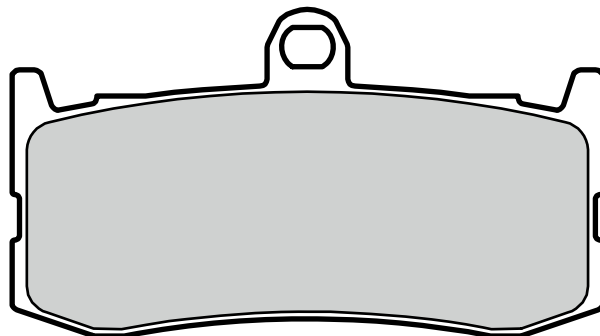

**TRIUMPH**

675	DAYTONA TRIPLE	09 >	•
-----	----------------	------	---



**07GR07.SD** 76.4 x 38 x 6.9

**07GR07.SX** “ “ “

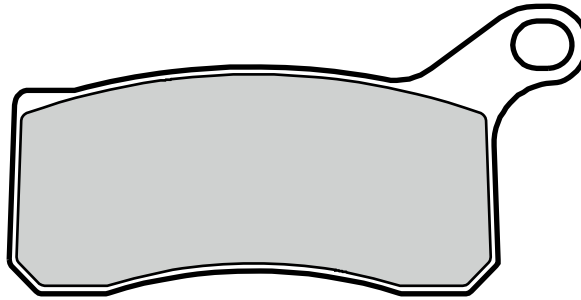
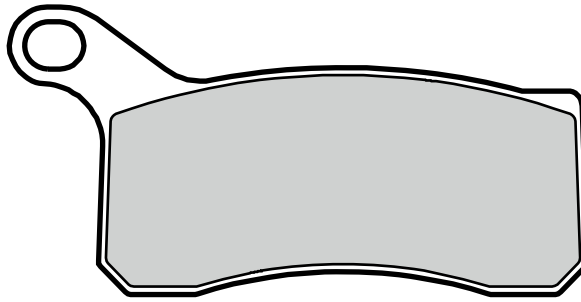

**HM**

50	CRE SIX COMPETITION	09 >	•
50	CRM DERAPAGE	09 >	•
125	CRM DERAPAGE	11 >	•

**KTM**

450	SX ATV	08 >	•
450	XC ATV	08 >	•
505	SX ATV	08 >	•
505	XC ATV	08 >	•



**07GR08.SD** 58.7 x 35.3 x 8.2

**07GR08.SX** “ “ “

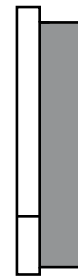
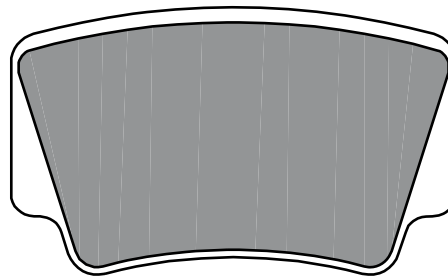

**KTM**

450	SX ATV	08 >	•
450	XC ATV	08 >	•
505	SX ATV	08 >	•
505	XC ATV	08 >	•





**07GR09.CC** 88.2 x 48.9 x 7.8  
55.6 x 35.9 x 10.3

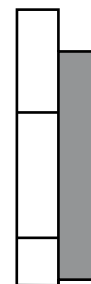
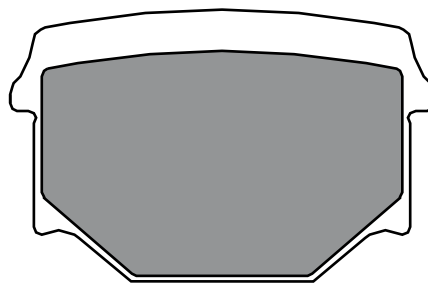
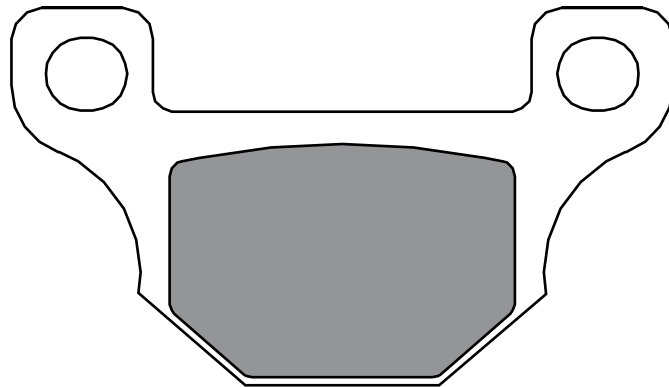

### DERBI

125	MULHACEN	08 >	•
125	SENDA DRD R/SM	09 >	•
125	TERRA	08 >	•
125	TERRA ADVENTURE	08 >	•

### RIEJU

50	MRT	09 > 10	• •
50	MRT SUPERMOTARD	09 >	• •
50	RRX	08 >	• •

50 SPIKE X 08 > • •

125	MARATHON PRO	09 >	•
125	MARATHON PRO SUPERMOTARD	09 >	•

### SUZUKI

125	GN	05 >	•
125	GN Z, E	82 > 90	•
125	GS E, KATANA	90 > 94	•
125	GS ESD	83 > 94	•

### TGB

50	BULLET	09 >	•
50	BULLET	10 >	•
50	BULLET RR	11 >	•
50	BULLET RS	11 >	•
50	CORONA	03 >	•
50	RX	06 >	•
125	BULLET RR	11 >	•
125	BULLET RS	11 >	•



**07GR10.01** 43.4 x 64.4 x 7

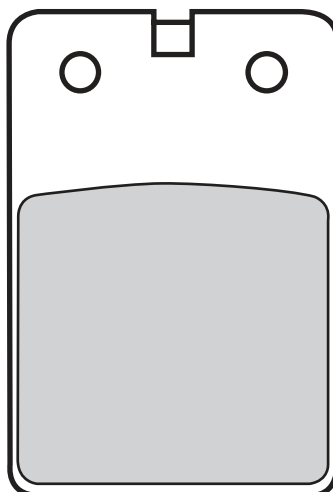

**FANTIC MOTOR**

125 SPORT 84 > 85 •

**GILERA**

125 RV 83 > 85 •  
200 RV 85 > 86 •



**MOTO MORINI**

400 S 84 > •  
500 6 V CLASSIC 89 > •



**07GR11.CC** 84.7 x 36.6 x 7.9  
47.7 x 31.4 x 12.2

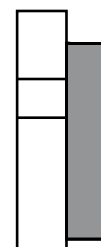
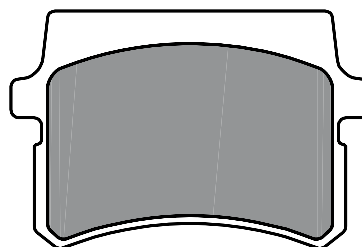
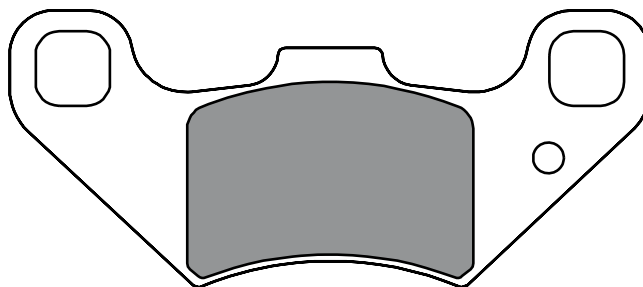

**PGO**

50 BUGRIDER 06 > •  
150 BR BUGXTER 05 > •

200 BR BUGRIDER 07 > •  
250 BR BUGRIDER 05 > •



**QUADZILLA**

250 E 250 06 > •  
250 XRV, E 06 > •





<b>07GR12.CC</b>	76.9 x 41.9 x 7.5
<b>07GR12.SA</b>	“ “ “
<b>07GR12.SC</b>	“ “ “
<b>07GR12.SP</b>	“ “ “

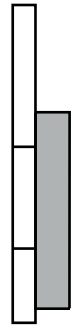
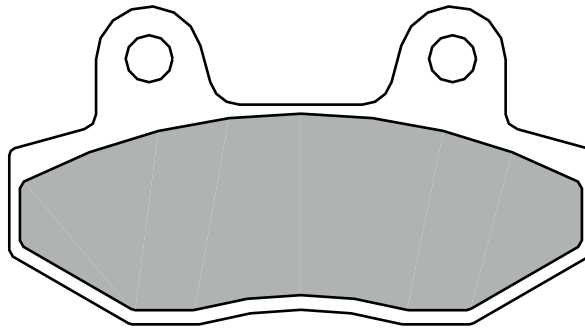

### BETA

150 R	10 >	•
-------	------	---

### GARELLI

125 XO' I	10 > 11	•
150 XO' I	10 > 11	•
200 XO' I	10 > 11	•

### HYOSUNG

125 GT	07 >	• •
125 GT COMET	04 >	• • •
125 GT NAKED	13 >	• • •
125 GT R SUPERSPORT	07 >	• • •

125	GV AGUILA	05 >	•
125	RT KARION	07 >	• •
125	RX SM	07 >	• • •
125	XRX	07 >	• • •
250	GT COMET	03 >	• • •
250	GT IR	13 > 14	• • •
250	GT P	13 >	• • •
250	GT R	07 >	• • •
650	GT	04 >	• • •
650	GT CUSTOM		
650	TRENDKILLER	07 >	• • •
650	GT I	13 >	• • •
650	GT IR	13 >	• • •
650	GT R	05 >	• • •

650	GT S	05 >	• • •
650	GT TTC	07 >	• • •
650	GT X	07 >	• • •
650	GV AGUILA	06 >	• • •
650	i NAKED	15 >	• • •
700	I DELUXE	13 >	• • •

### ITALJET

50	ROLLERCRAFT	08 >	• • •
125	TORPEDO	08 >	• • •
150	TORPEDO	08 >	• • •
650	BAZOOKA	06 >	• • •
650	GRIFON	06 >	• • •



**07GR13.CC** 78.9 x 46.9 x 7.3

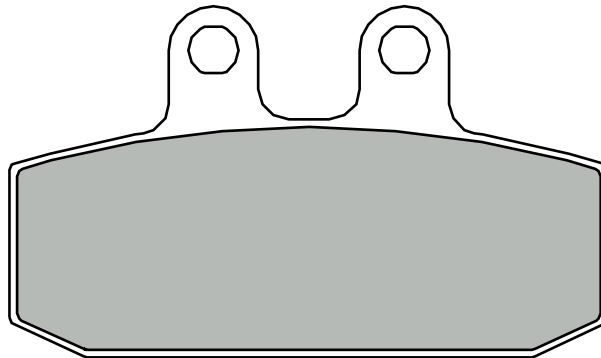

### APRILIA

125 ETX	86 > 87	•
125 RED ROSE	89 > 89	•
600 ETX	86 >	•
850 MANA	08 >	•
850 MANA GT	09 >	•

### CAGIVA

125 ROADSTER	94 >	•
200 ROADSTER	96 >	•

### FANTIC MOTOR

250 RAIDER LC	84 >	•
---------------	------	---

### GARELLI

125 TIGER XLE	86 >	•
---------------	------	---

### GILERA

125 COUGAR	99 >	•
125 ER	86 >	•
125 FAST BIKE	88 >	•
125 KK	85 >	•

125 KR	85 >	•
125 KZ	85 >	•
125 MXR	90 >	•
125 NEBRASKA	86 >	•
125 R1	88 >	•
125 RTX	85 >	•
125 XR1	88 >	•
125 XR2	88 >	•
200 ARIZONA HAWK	85 >	•
200 ER	87 >	•
250 ARIZONA RALLY	70 >	•
350 DAKOTA	89 >	•
350 XRT	89 >	•
500 DAKOTA	86 >	•
600 XRT	89 >	•

### HONDA

125 CA REBEL	97 >	•
125 CITYFLY	99 >	•
125 CRM	90 > 98	•
125 MTX CAMEL	88 >	•
125 MTX R	86 >	•
125 NS	85 > 88	•
125 NSR F	90 > 92	•

125 NSR R, ITALY	89 >	•
125 NX	90 > 98	•
125 RTV NSR	87 >	•
125 XL R, P.D.	85 >	•
200 XL R, P.D.	85 >	•

### MALAGUTI

500 SPIDER MAX GT	04 >	•
500 SPIDER MAX RS	09 >	•

### MOTO GUZZI

750 V7 II SPECIAL	15 >	•
750 V7 II STONE	15 >	•

### SACHS

125 ROADSTER	01 >	•
125 ZX	99 >	•
125 ZZ	99 >	•

### SIMSON

125 RS	01 >	•
125 SCHIKRA	99 >	•



**07GR14.06** 76.5 x 41.9 x 7.3

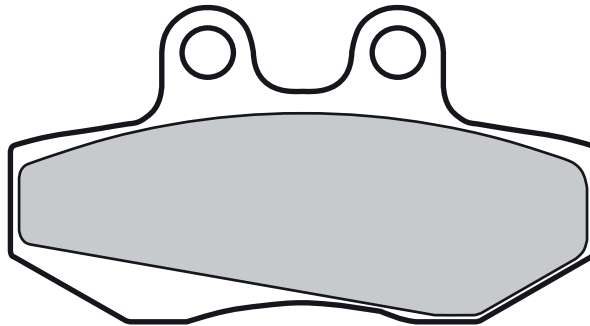

### APRILIA

125 CLASSIC	96 >	•
125 PEGASO	90 > 91	•
125 RED ROSE	90 >	•
125 TUAREG RALLY	92 >	•
125 TUAREG WIND	89 > 89	•
125 TUAREG WIND	90 >	•
600 PEGASO	90 >	•

### BETA

50 PRO RACE	98 >	•
50 RR ENDURO	99 > 03	•
50 RR STANDARD	99 >	•
50 RR SUPERMOTARD	99 > 03	•

### BULTACO

50 ASTRO	01 >	•
50 LOBITO	99 >	•

### DERBI

50 GPR	98 > 08	•
50 SENDA R	03 > 04	•
125 ATMOSPHERE	99 >	•
180 PREDATOR	99 >	•

### GAS GAS

50 EC ROOKIE	01 > 04	•
50 SM ROOKIE	01 >	•

### GILERA

150 RUNNER FX	97 >	•
200 FX RUNNER	97 > 98	•

### HRD

50 GS ENDURO	00 >	•
50 SONIC	00 > 02	•
50 SONIC TRIAL	00 > 02	•
125 SUPERMOTARD	00 >	•
125 TRIAL	00 >	•

### HUSQVARNA

50 SM	02 > 09	•
50 WR	02 >	•

### ITALJET

50 SM	02 >	•
125 SM	02 >	•

### PEUGEOT

50 XR6	02 > 07	•
--------	---------	---



### RIEJU

50 MRX PRO	05 >	•
50 RACING	01 >	•
50 RS2 MATRIX	03 >	•
50 SMX	02 >	•
50 SPIKE	02 >	•
50 SPIKE (AJP CALIPER)	02 >	•
125 MRX	03 >	•
125 SMX	03 >	•

### SHERCO

50 ENDURO	02 >	•
50 SM	02 >	•
125 125	02 >	•
125 CITY CORP 4T ENDURO	03 >	•
125 CITY CORP 4T SM	03 >	•

### SIAMOTO

125 BD	02 >	•
--------	------	---

### SIMSON

125 SM	01 >	•
--------	------	---

### YAMAHA

125 XT X SUPERMOTARD	05 >	•
----------------------	------	---



**07GR15.06** 99.6 x 46.9 x 7.4

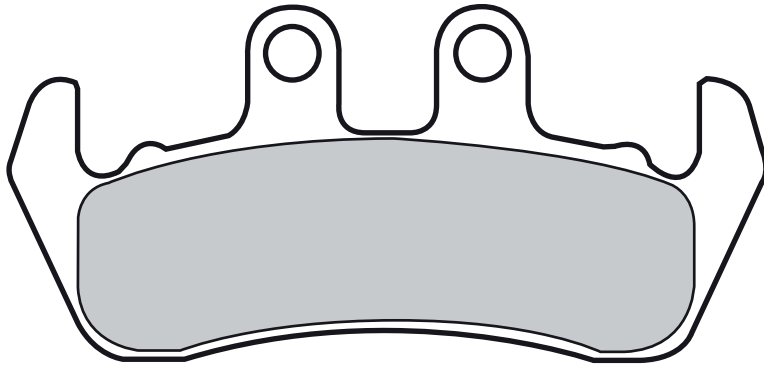

**YAMAHA**

125	DT TENERE SCOUT	90 >	•
125	DTZ TENERE	90 >	•



**07GR16.SD** 40.8 x 42.1 x 7.4

**07GR16.SX** " " "

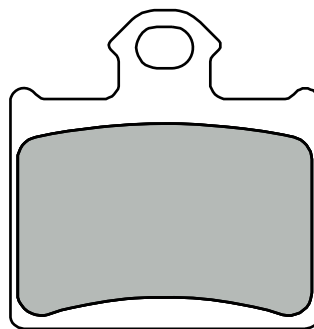

**HUSQVARNA**

65	CR	12 >	•
85	TC	14 >	•

**KTM**

	FREERIDE E	15 >	•
85	SX	11 > 11	•
85	SX	12 >	•
250	FREERIDE R	14 >	•
350	FREERIDE	12 >	•



**07GR17.05** 55.4 x 46.4 x 6

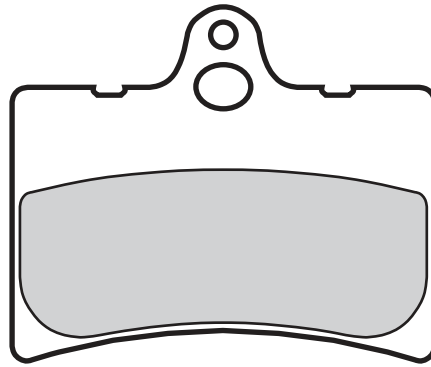

**BETA**

260 TR34	93 >	•
----------	------	---

**CAGIVA**

50 PRIMA	93 >	•
80 PRIMA	92 >	•
125 PRIMA	92 >	•



**07GR18.CC** 69.4 x 45.4 x 8.7

**07GR18.SA** “ “ “

**07GR18.SC** “ “ “

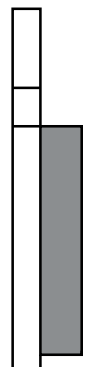
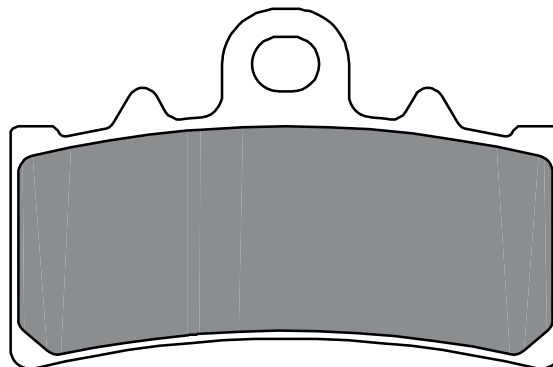

**KTM**

125 DUKE	11 > 14	•
125 RC	14 >	•
200 DUKE	12 > 14	•
200 RC	14 >	•
390 DUKE	13 > 14	•
390 RC	14 >	•



**07GR19.CC** 40.9 x 42.8 x 5.3

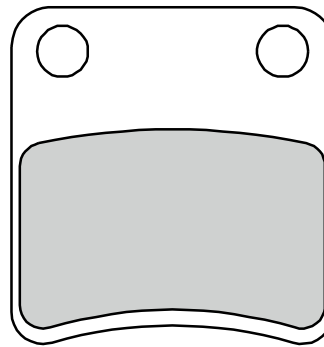

### APRILIA

850	MANA GT (PARKING BRAKE)	09 >	•
-----	-------------------------	------	---

### HONDA

700	CTX D ABS W/DCT (PARKING BRAKE)	14 >	•
-----	---------------------------------	------	---

700	CTX ND ABS W/DCT (PARKING BRAKE)	14 >	•
700	NC SD ABS W/DCT (PARKING BRAKE)	12 >	•
700	NC X PARKING BRAKE	12 >	•
700	TRX INTEGRA PARKING BRAKE	12 >	•
700	VULTUS ABS w/DCT parking brake	15 >	• •

750	NC X (PARKING BRAKE)	14 >	•
750	NCS (PARKING BRAKE)	14 >	•
750	VULTUS ABS w/DCT	15 >	•
750	VULTUS ABS w/DCT parking brake	15 >	•
1200	CROSSTOURER PARKING BRAKE	12 >	•
1200	VFR FW PARKING BRAKE	10 >	•



**07GR20.SD** 58.6 x 39.7 x 7.5

**07GR20.SX** " " "

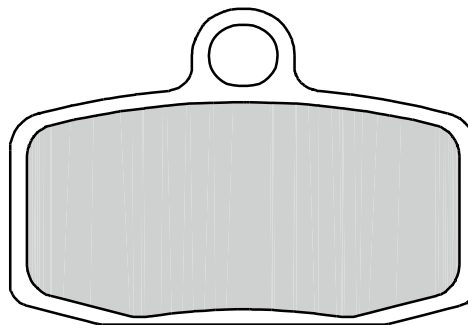

### HUSQVARNA

85	TC	14 >	•
----	----	------	---

### KTM

	FREERIDE E	15 >	•
85	SX	12 >	•
250	FREERIDE R	14 >	•
350	FREERIDE	12 >	•





**07GR21.06** 87.1 x 53 x 7.4

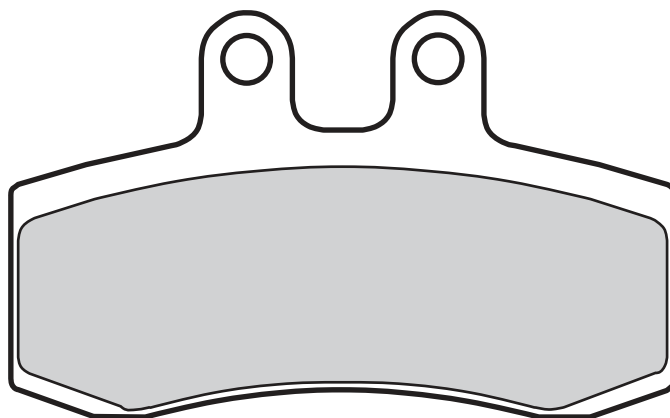

**APRILIA**

650 PEGASO 92 > 95 •

**MZ**

125 SM 99 > 01 •  
125 SX 99 > 01 •

660 BAGHIRA MUZ	96 >	•
660 BLACK PANTHER MUZ	00 >	•
660 MASTIFF MUZ	00 >	•
660 STREET MOTO MUZ	00 >	•



**07GR22.SD** 67.1 x 51.9 x 7.5

**07GR22.SX** “ “ “

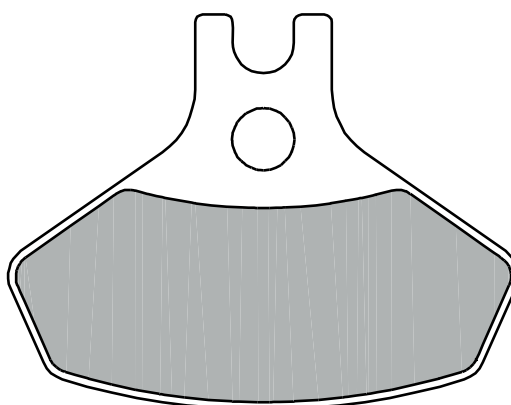

**BOMBARDIER-CAN AM**

450 DS 08 > 12 •



**07GR23.CC** 35.8 x 42.1 x 5.9

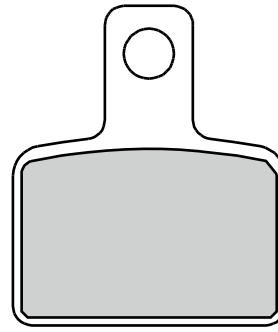

**BETA**

125	EVO	09 >	•
200	EVO	09 >	•
250	EVO (2-T / 4-T)	09 >	•
290	EVO	09 >	•
300	EVO	09 >	•



**07GR24.CC** 40.8 x 44.6 x 6.4

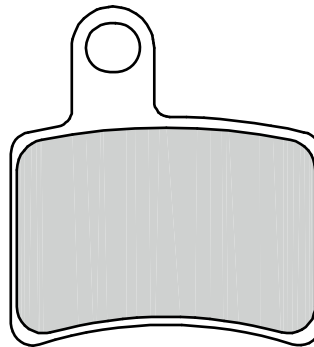

**BETA**

80	REV	08 >	•
125	REV 3	06 >	•
200	REV3	06 >	•
250	REV 3	05 >	•
250	REV 3 4-T	07 >	•
270	REV 3	05 >	•

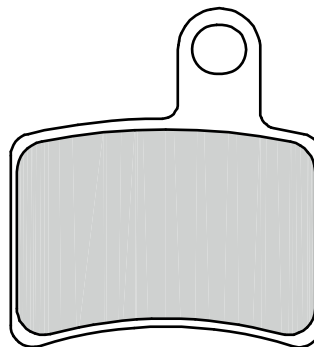



**07GR25.SD** 95.2 x 39.7 x 7.1

**07GR25.SX** “ “ “

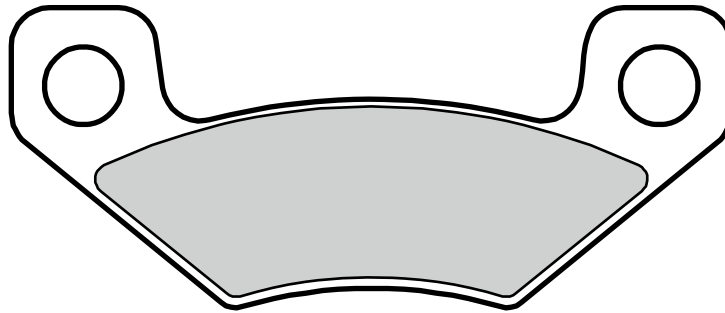

**BOMBARDIER-CAN AM**

450 DS 08 > 12 •



0821 000 555



0821 000 777



+33 3 89 70 3000



+33 3 89 70 30 99



**07GR26.SD** 95.1 x 36 x 7.6  
109.4 x 39.9 x 7.6

**07GR26.SX** “ “ “

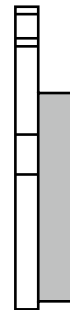
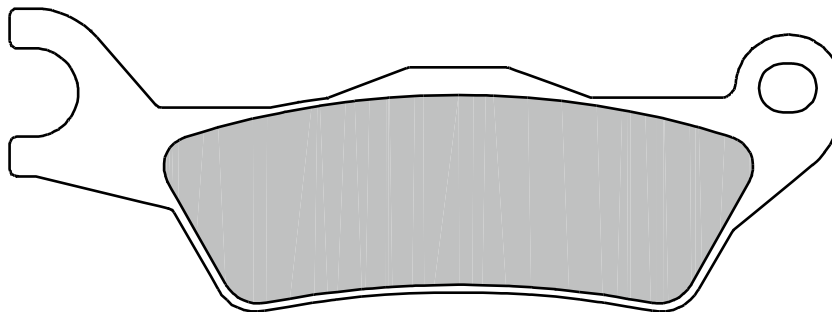
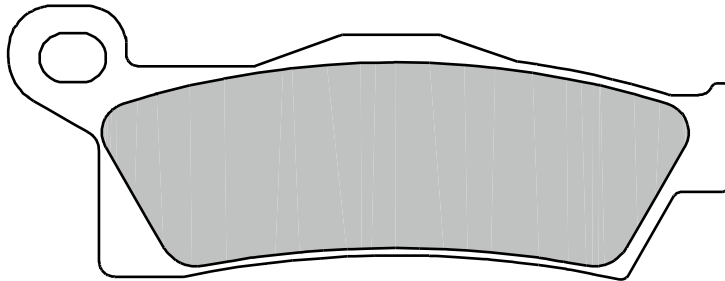

### BOMBARDIER-CAN AM

450	OUTLANDER MAX RIGHT/REAR	15 >	• •	500	RENEGADE LEFT	12 > 13	• •	800	RENEGADE LEFT	12 > 13	• •
	OUTLANDER RIGHT/REAR	15 >	• •	500	RENEGADE RIGHT/REAR	14 >	• •	800	RENEGADE RIGHT	12 > 13	• •
450	OUTLANDER LEFT/REAR	13 >	• •	650	OUTLANDER LEFT	13 >	• •	800	RENEGADE RIGHT/REAR	14 >	• •
500	OUTLANDER MAX LEFT/REAR	13 >	• •	650	OUTLANDER LEFT/REAR	13 >	• •	1000	OUTLANDER LEFT/REAR	12 >	• •
500	OUTLANDER MAX RIGHT	13 >	•	650	OUTLANDER MAX LEFT	13 >	•	1000	OUTLANDER MAX LEFT/REAR	12 >	• •
500	OUTLANDER RIGHT	13 >	•	650	OUTLANDER MAX RIGHT/REAR	13 >	•	1000	OUTLANDER MAX RIGHT	12 >	•
				650	OUTLANDER RIGHT/REAR	13 >	•	1000	OUTLANDER RIGHT	12 >	•
				800	OUTLANDER LEFT/REAR	12 >	• •	1000	RENEGADE LEFT	12 > 13	• •
				800	OUTLANDER MAX RIGHT/REAR	13 >	• •	1000	RENEGADE RIGHT	12 > 13	•



**07GR27.SD** 95.1 x 36 x 7.6  
109.4 x 39.9 x 7.6

**07GR27.SX** “ “ “

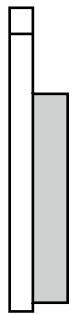
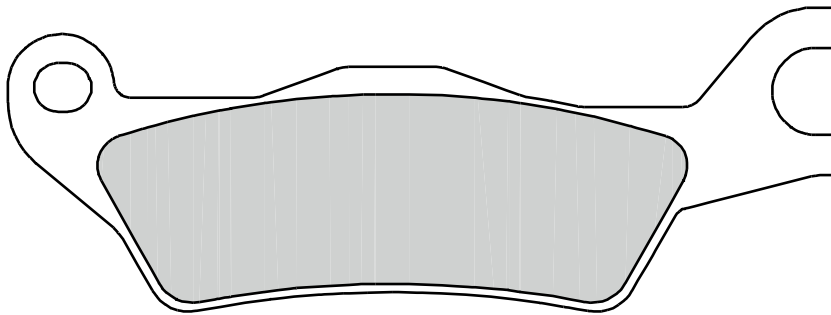
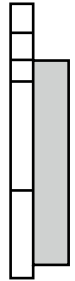
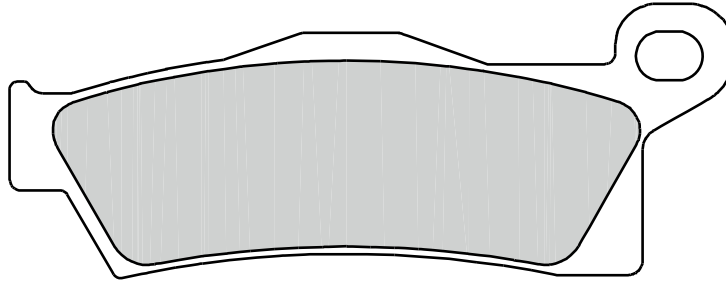

**BOMBARDIER-CAN AM**

450	OUTLANDER LEFT	15 >	•
450	OUTLANDER MAX/LEFT	15 >	•
500	OUTLANDER MAX RIGHT	13 >	•
500	OUTLANDER RIGHT	13 >	•
500	RENEGADE LEFT	14 >	• •

500	RENEGADE RIGHT	12 > 13	• •
650	OUTLANDER MAX RIGHT/REAR	13 >	•
650	OUTLANDER RIGHT	13 >	•
650	OUTLANDER RIGHT/REAR	13 >	•
800	OUTLANDER MAX LEFT	13 >	•

800	OUTLANDER RIGHT	12 >	•
800	RENEGADE LEFT/REAR	14 >	• •
800	RENEGADE RIGHT	12 > 13	•
1000	OUTLANDER MAX RIGHT	12 >	•
1000	OUTLANDER RIGHT	12 >	•
1000	RENEGADE RIGHT	12 > 13	•



**07GR35.SP** 69.4 x 42.5 x 7.5

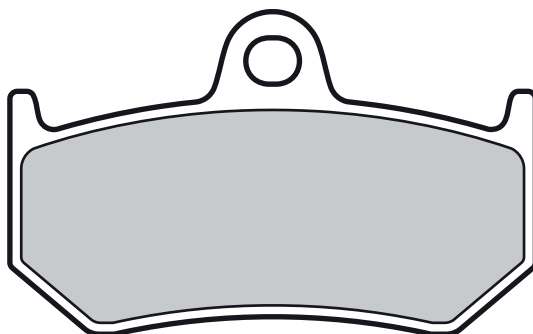

### MV AGUSTA

750	BRUTALE	03 >	•
750	BRUTALE AMERICA	04 >	•
750	BRUTALE GLADIO	05 >	•
750	BRUTALE MAMBA	05 >	•
750	BRUTALE ORO	02 >	•
750	BRUTALE S	02 >	•
750	F4	00 > 04	•
750	F4 AGO	03 >	•
750	F4 SPR	03 >	•
910	BRUTALE R	06 >	•

910	BRUTALE S	04 >	•
920	BRUTALE	12 >	•
989	BRUTALE R	08 >	•
990	BRUTALE R	10 >	•
1000	F4 312 R	07 >	•
1000	F4 CORSE	05 >	•
1000	F4 MAMBA	03 >	•
1000	F4 R	06 >	•
1000	F4 R 1+1	06 >	•
1000	F4 R CORSA CORTA	12 >	•
1000	F4 RR	11 >	•
1000	F4 RR CORSA CORTA	12 >	•

1000	F4 S, 1+1	04 >	•
1000	F4 SENNA	06 >	•
1000	F4 TAMBURINI	04 >	•
1078	BRUTALE RR	08 >	•
1078	BRUTALE RR	09 >	•
1078	F4 312 RR	08 >	•
1078	F4 CC	08 >	•
1090	BRUTALE	13 >	•
1090	BRUTALE CORSA	14 >	•
1090	BRUTALE R	12 >	•
1090	BRUTALE RR	10 > 11	•
1090	BRUTALE RR	12 >	•



**07GR48.04** 35.6 x 38.5 x 6

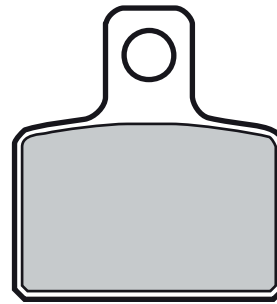

#### APRILIA

50 MINI RX 04 > •

#### BETA

50 PRO RACE 04 > • •

#### GAS GAS

125 RANDONE 12 > •

125 TXT 04 > •

125 TXT PRO RACING 14 > •

125 TXT PRO REPLICA 13 > •

200 TXT 04 > •

250 TXT 04 > •

250 TXT PRO RACING 14 > •

250 TXT PRO REPLICA 13 > •

280 TXT 04 > •

280 TXT PRO RACING 14 > •

280 TXT PRO REPLICA 13 > •

300 TXT 04 > •

300 TXT PRO RACING 14 > •

300 TXT PRO REPLICA 13 > •

#### HONDA

250 COTA 4 RT 05 > •

260 COTA 4 RT 14 > •

#### HUSQVARNA

50 CR JUNIOR 06 > •

50 CR PRO SENIOR 06 > •

50 CR SENIOR 06 > •

#### JOTAGAS

125 JT 14 > •

250 JT 14 > •

280 JT 14 > •

300 JT 14 > •

#### MONTESA

250 COTA 4RT 05 > •

260 COTA 4RIDE 16 > •

260 COTA 4RT 14 > •

260 COTA 4RT RACE 15 > •

300 COTA RR 15 > •

360 315R 01 > 04 •



#### OSSA

280 TRI 10 > •

280 TRI EXPLORER 12 > •

300 TRI FACTORY R 15 > •

#### SCORPA

115 SY F TRIAL 06 > •

115 TY-S F TRIAL 06 > •

125 SY F TRIAL 06 > •

125 TY-S F TRIAL 06 > •

250 SY F TRIAL 06 > •

250 SY TRIAL 00 > •

#### SHERCO

125 ST 06 > •

250 2.5 01 > •

290 2.9 01 > •

320 3.2 4T 05 > •

#### VERTIGO

300 COMBAT CAMO WORKS 15 > •

300 COMBAT ICE HELL 15 > •

300 COMBAT RR 15 > •



**07GR49.SD** 62 x 40.7 x 9.5  
82.2 x 40.7 x 9.5

**07GR49.SX** “ “ “

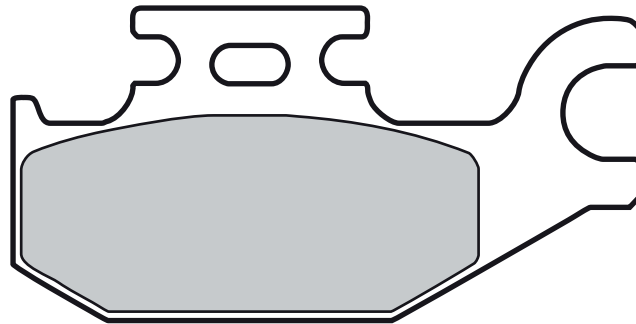
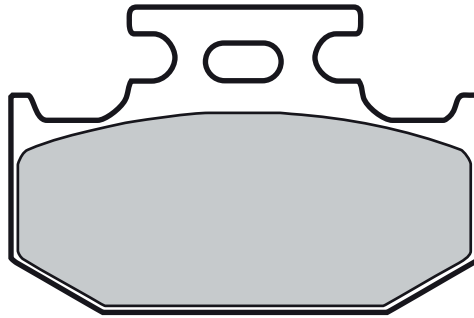

### BOMBARDIER-CAN AM

250 DS left/rear	06 >	• •
330 OUTLANDER LEFT/REAR	03 >	• •
400 OUTLANDER LEFT/REAR	03 > 06	• •
400 OUTLANDER LEFT/REAR	07 >	•
400 OUTLANDER MAX LEFT/REAR	03 > 06	• •
400 OUTLANDER MAX LEFT/REAR	07 >	•
500 QUEST LEFT/REAR	02 >	• •
500 TRAXTER 4X4 LEFT/REAR	01 >	• •
500 TRAXTER MAX LEFT/REAR	03 > 05	•
650 DS (DS650/EBE)	01 >	• •
650 QUEST (QUEST/EBE)	02 >	• •

650 QUEST MAX LEFT/REAR 03 > •

650 TRAXTER MAX LEFT/REAR 03 > 05 •

800 OUTLANDER 06 > • •

800 OUTLANDER XT 06 > • •

1000 COMMANDER MAX LEFT 14 > •

1000 MAVERICK LEFT 13 > •

### CANNONDALE

440 BLAZE LEFT/REAR 03 > • •

440 CANNIBAL left/rear 03 > •

440 CANNIBAL right 03 > •

440 GLAMIS left/rear 03 > • •

440 MOTO LEFT/REAR 03 > • •

### SUZUKI

125 BURGMAN ABS	14 >	•
200 BURGMAN ABS	14 >	•

### YAMAHA

400 XT	86 >	•
400 YFM FAM KODIAK	00 >	•
400 YFM FWN BIG BEAR 4WD	00 >	•
400 YFM FWNH BIG BEAR-BUCKMASTER 4WD	00 >	•
400 YFM N BIG BEAR 2WD	00 >	•
450 YFM FA_ KODIAK	03 >	•
450 YFM KODIAK	03 >	•
450 YFM WOLVERINE	06 >	•





**07GR50.SD** 62 x 40.7 x 9.5  
82.2 x 40.7 x 9.5

**07GR50.SX** " " "

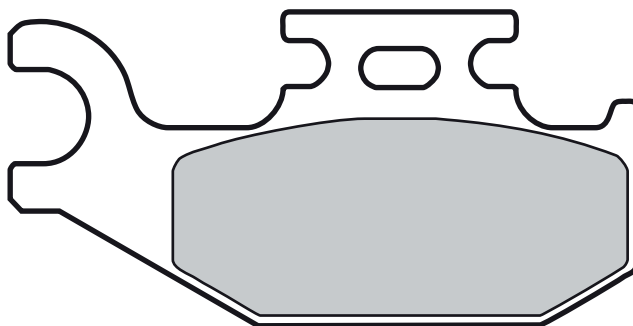
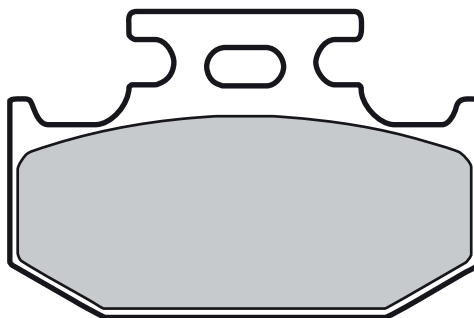

### BOMBARDIER-CAN AM

250 DS RIGHT	06 >	•
330 OUTLANDER RIGHT	03 >	•
400 OUTLANDER LEFT/REAR	07 >	•
400 OUTLANDER MAX LEFT/REAR	03 >	•
400 OUTLANDER MAX LEFT/REAR	07 >	•
400 OUTLANDER RIGHT	03 >	•
500 QUEST RIGHT	02 >	•
500 TRAXTER 4X4 RIGHT	01 >	•

500 TRAXTER 4X4 RIGHT	03 > 05	• •
650 DS RIGHT (DS650/EBE)	01 >	•
650 QUEST MAX LEFT/REAR	03 >	•
650 QUEST MAX RIGHT	03 >	•
650 QUEST RIGHT (QUEST/EBE)	02 >	•
650 TRAXTER MAX	03 > 05	•
650 TRAXTER MAX LEFT/REAR	03 > 05	•
800 OUTLANDER	06 >	•
800 OUTLANDER XT	06 >	•

1000 COMMANDER MAX RIGHT	14 >	•
1000 MAVERICK RIGHT	13 >	•

### CANNONDALE

440 BLAZE RIGHT	03 >	•
440 CANNIBAL left/rear	03 >	•
440 CANNIBAL right	03 >	•
440 GLAMIS left/rear	03 >	•
440 MOTO	03 >	•
440 SPEED	03 >	•



**07GR51.05** 56.4 x 43.5 x 6.6

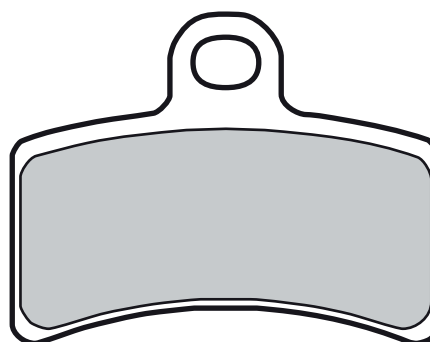

### GAS GAS

50 EC BOY	01 >	• •
50 EC ROOKIE	01 > 04	•

50 SM ROOKIE	01 >	•
50 TXT BOY	01 > 03	• •
50 TXT ROOKIE	02 > 03	• •
65 MC	05 >	• •

80 TXT ROOKIE	02 > 03	• •
125 PAMPERA	04 >	•
250 PAMPERA	02 >	•
280 PAMPERA	04 >	•



<b>07GR52.09</b>	94 x 47 x 8.7 73 x 47 x 10.7
------------------	---------------------------------

<b>07GR52.SD</b>	“ “ “
------------------	-------

<b>07GR52.SX</b>	“ “ “
------------------	-------

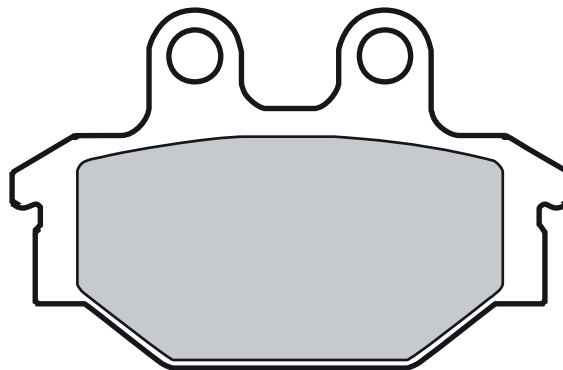
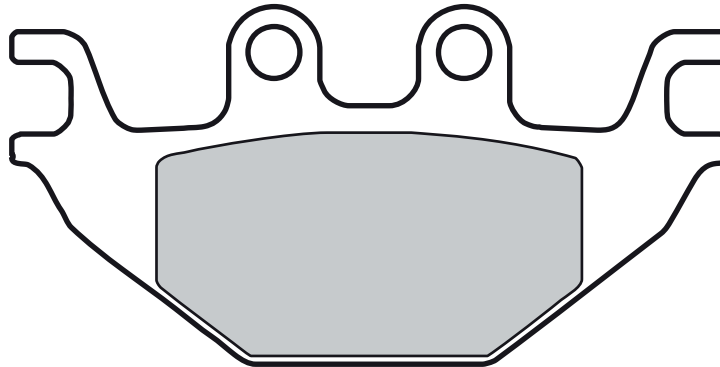

### ADLY

300	ATV SPORT	07 >	•
300	CROSS X OVER	07 >	•
300	CROSS X ROAD	07 >	•
320	320 S	07 >	•
320	320 U	07 >	•

### ARCTIC CAT

250	DVX	06 > 09	•
300	DVX	09 >	•

### CPI

250	XS ATV	07 >	•
-----	--------	------	---

### HERCULES

280	ATV	07 >	•
-----	-----	------	---

### KAWASAKI

300	KVF BRUTE FORCE	13 >	•
-----	-----------------	------	---

### KYMCO

250	KXR	04 >	•
250	KXR (L3/E4/0235)	04 >	•
250	MXU	06 >	•
250	URBAN QUAD	06 >	•
300	MAXXER	06 >	•
300	MAXXER SUPERMOTO	15 >	•
300	MXU	06 >	• •
500	MXU	06 >	• •
500	UXV	08 >	• •

### SYM

125	SB WOLF	11 >	•
-----	---------	------	---

200	TRACKRUNNER	06 >	• •
250	QUADLANDER	06 >	•
250	SB	14 >	•
250	SN NI WOLF	14 >	•
300	CITY MAX	06 >	•
300	CITYCOM	15 >	•
300	QUADLANDER	06 >	• •
300	SB CAFE' RACER	16 >	•
300	WOLF CAFE' RACER	15 >	•
300	WOLF CLASSIC	15 >	•
600	QUAD RAIDER	08 >	• •

### YAMAHA

125	MT	14 >	•
125	YZF R	08 > 13	•
125	YZF R	14 >	•



**07GR53.SD** 94.5 x 45.5 x 7

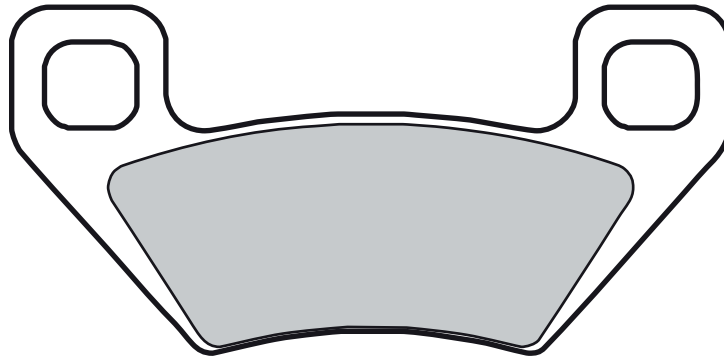

**ARCTIC CAT**

250	2X4	05 >	• •
300	2X4	10 >	•
300	4X4	05 >	• •
400	2X4/4X4 (FIS)	05 >	• •
400	TRV	09 >	• •
450	H1	10 >	• •
450	XC	11 >	• •
500	2X4/4X4 (FIS)	05 >	• •
500	TBX 4X4	05 >	• •
500	TRV 4X4	05 >	• •

550	H1	09 >	• •
550	LTD	09 >	• •
550	PROWLER	09 >	• •
550	TRV	09 >	• •
650	H1 4X4 AUT.	05 >	• •
650	PROWLER	06 >	• •
650	V2 4X4 AUT.	05 >	• •
650	V2 4X4 AUT. LE	05 >	• •
700	DIESEL	06 >	• •
700	H1	09 >	• •
700	PROWLER	08 >	• •

700	TBX	12 >	• •
700	TRV	09 >	• •
1000	PROWLER	09 >	• •
1000	THUNDERCAT	09 >	• •
1000	TRV	09 >	• •

**KYMCO**

400	MAXXER	08 > 10	• •
400	MXU	08 > 11	• •
450	MAXXER	10 >	• •
450	MXU I	11 >	•



**07GR54.SD** 67.6 x 44 x 7.7

**07GR54.SX** “ “ “

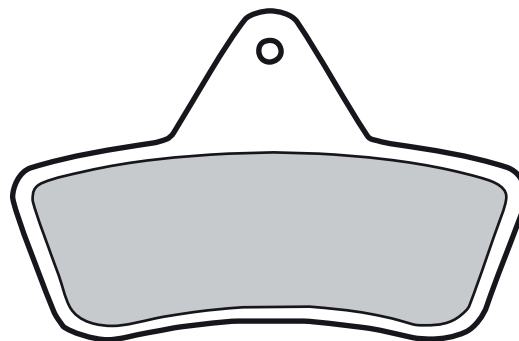

**ARCTIC CAT**

250	2X4/4X4	99 > 04	• •
300	2X4/4X4	98 > 04	• •
375	2X4/4X4	02 >	• •
400	2X4/4X4	98 > 04	• •
400	2X4/4X4 (FIS)	02 > 04	• •
400	TBX 4X4	04 >	• •

454	ARCTIC CAT 4X4	98 >	• •
454	BEAR CAT 2X4/4X4	96 > 98	• •
500	2X4/4X4	98 > 04	• •
500	2X4/4X4 (FIS)	02 > 04	• •
500	TBX 4X4	02 > 04	• •
500	TRV 4X4	03 > 04	• •

**LAVERDA**

125	HP QUASAR	04 >	•
180	HP QUASAR	04 >	•
400	QUASAR 4X4	04 >	• •
500	QUASAR 4X4	04 >	• •
500	QUASAR 4X4 C	04 >	• •



**07GR55.SD** 43.2 x 25.4 x 8.4



### ARCTIC CAT

250	2X4 (MAN. HAND BRAKE)	99 >	•
250	4X4 (MAN. HAND BRAKE)	00 >	•
300	2X4 (MAN. HAND BRAKE)	98 > 04	•
300	4X4 (MAN. HAND BRAKE)	98 >	•
375	2X4/4X4 (MAN. HAND BRAKE)	02 >	•
400	2X4 (MAN. HAND BRAKE)	98 > 02	•

400	2X4/4X4 (FIS) AUT. (MAN. HAND BRAKE)	03 > 04	•
400	2X4/4X4 (FIS)(MAN. HAND BRAKE)	02 > 04	•
400	4X4 (MAN. HAND BRAKE)	98 > 04	•
400	TBX 4X4 (MAN. HAND BRAKE)	04 >	•
454	BEAR CAT 2X4/4X4 (MAN. HAND BRAKE)	98 >	•
500	2X4 (FIS)(MAN. HAND BRAKE)	02 >	•
500	2X4 (MAN. HAND BRAKE)	02 >	•

500	4X4 (FIS) AUT.(MAN. HAND BRAKE)	02 > 03	•
500	4X4 (FIS)(MAN. HAND BRAKE)	02 > 03	•
500	4X4 (MAN. HAND BRAKE)	98 > 02	•
500	TBX 4X4 (MAN. HAND BRAKE)	03 > 04	•
500	TBX 4X4 AUT.(MAN. HAND BRAKE)	02 >	•
500	TRV 4X4 (MAN. HAND BRAKE)	03 > 04	•



**07GR56.05** 67.4 x 50.9 x 7

**07GR56.SC** “ “ “

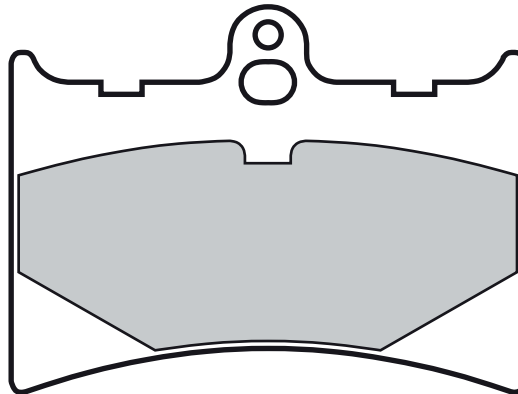

### ALFER

125 MC	88 >	•
250 GR ENDURO	88 >	•
250 MC	88 >	•
300 GR ENDURO	88 >	•

### APRILIA

125 AF-1 EUROPA	89 > 91	•
125 AF-1 FUTURA	89 > 91	•
125 AF1 REPLICA, SINTESI	88 > 89	•
125 RS	99 > 05	•
125 RS EXTREMA	93 > 98	•
125 RS PISTA	04 > 05	•
125 RS REPLICA	93 > 97	•
125 SPORT PRODUCTION	92 >	•
125 TUONO	04 >	•

### ASPES

125 SINTESI	88 >	•
-------------	------	---

### BENELLI

125 BX	89 >	•
125 JARNO	89 >	•

### GILERA

125 CHRONO	91 >	•
125 CX	91 >	•
125 FREESTYLE	92 >	•
125 MX1	88 >	•
125 SP 01	89 >	•
125 SP 02	89 >	•
600 NORDWEST	90 >	•

### KTM

125 GS	87 > 87	• •
125 MX	87 > 87	• •
250 GS	87 > 87	• •
250 MX	87 > 87	• •
500 MX	87 > 87	• •
600 MC, LC4, ENDURO	88 >	• •

### MOTO GUZZI

1000 QUOTA	92 > 95	•
------------	---------	---

### MZ

660 SKORPION SPORT MUZ	95 > 99	•
660 SKORPION TOUR MUZ	95 > 99	•
660 SKORPION TRAVELLER MUZ	99 >	•

### TM

125 CROSS	89 > 90	•
125 CROSS	91 >	•
125 ENDURO	89 > 90	•
125 ENDURO	91 >	•



**07GR57.05** 75 x 40.3 x 6.7

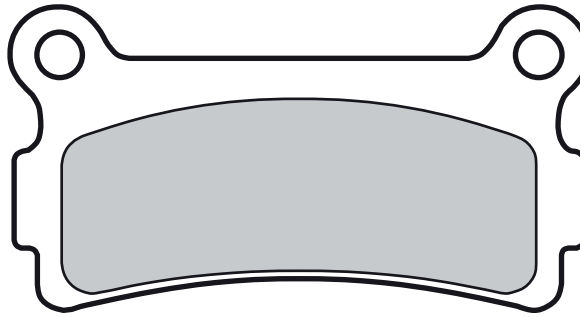

**BETA**

50	MX ENDURO	92 >	•
50	SUPER TRIAL	92 >	•
125	TRIAL	97 >	•

240	ALP	92 > 95	•
240	ALP	96 >	•
240	SUPER TRIAL	92 >	•
250	ALP	92 > 96	•
250	ZERO	91 >	•

260	SYNT	92 >	•
260	TR34	89 > 92	•
260	TR34	93 >	•
260	TR35	89 > 92	•
260	ZERO	91 >	•



**07GR58.04** 49.6 x 43.4 x 6  
**07GR58.SX** “ “ “

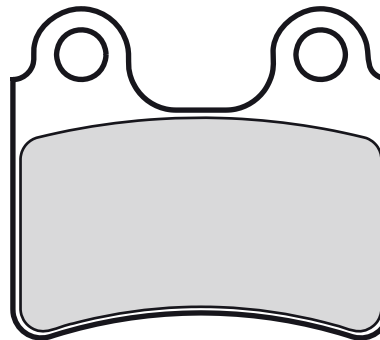

**BETA**

80	EVO	09 >	•
80	REV	08 >	•
125	EVO	09 >	•
125	REV 3	00 > 05	• •
125	REV 3	06 >	•
200	EVO	09 >	•
200	REV3	06 >	•
250	EVO ( 2-T / 4-T )	09 >	•
250	REV 3	00 > 04	• •
250	REV 3	05 >	•
250	REV 3 4-T	07 >	•
270	REV 3	00 > 04	• •
270	REV 3	05 >	•
290	EVO	09 >	•
300	EVO	09 >	•

**GAS GAS**

50	EC ROOKIE	05 >	•
125	RANDONE	12 >	•
125	TXT	04 >	•
200	TXT	04 >	•
250	TXT	04 >	•
280	TXT	04 >	•
300	TXT	04 >	•

**HONDA**

260	COTA 4 RT	14 >	•
-----	-----------	------	---

**MONTESA**

250	COTA 4RT	05 >	•
260	COTA 4RT	14 >	•
360	315R	01 > 04	•

**OSSA**

280	TR I	10 >	•
280	TR I EXPLORER	12 >	•

**SCORPA**

115	SY F TRIAL	06 >	•
125	SY F TRIAL	06 >	•
125	TY-S F TRIAL	06 >	•
250	SY F TRIAL	06 >	•
250	SY TRIAL	00 >	•

**SHERCO**

125	ST	06 >	•
250	2.5	01 >	•
290	2.9	01 >	•
320	3.2 4T	05 >	•



**07GR59.15** 71.6 x 34.9 x 9.4/13

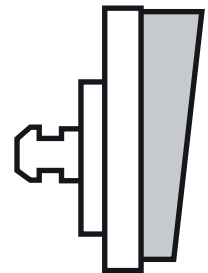
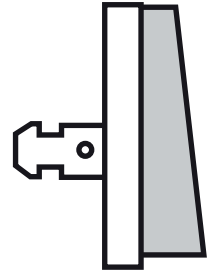

**BMW**

600 R 60/7	76 > 78 •
750 R 75/6	74 > 76 •
750 R 75/7	76 > 77 •

800 R 80/7	77 > 78 •
800 R 80/7	79 > 81 •
900 R 90 S	73 > 76 •
900 R 90/6	73 > 76 •
1000 R 100 RS	76 > 80 •

1000 R 100 RT	79 > 80 •
1000 R 100 S	76 > 77 •
1000 R 100 S	78 > 80 •
1000 R 100 T	79 > •
1000 R 100/7	76 > •



**07GR60.07** 55.6 x 52.8 x 9

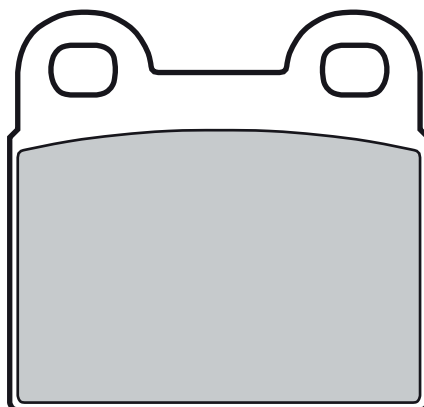

**BMW**

450 R 45

78 > 80 •

650 R 65

1000 R 100 CS

78 > 80 •

81 > 83 •

1000 R 100 RS

1000 R 100 RT

81 > 83 •

81 > 83 •



**07GR62.07** 81 x 45.9 x 9

**07GR62.SA** “ “ “

**07GR62.SC** “ “ “

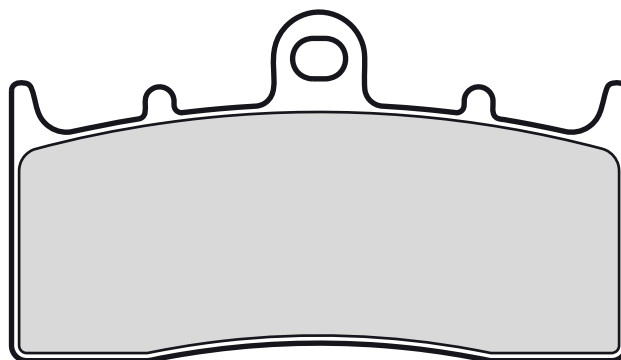

**BMW**

850 R 850 R

03 > •

1100 R 1100 S ABS

01 > •

1150 R 1150 GS

03 > 05 •

1150 R 1150 GS ADVENTURE

03 > 05 •

1150 R 1150 R

01 > •

1150 R 1150 R ROCKSTER

02 > •

1150 R 1150 RS

01 > •

1150 R 1150 S

03 > •

1200 K 1200 LT ABS

01 > •

1200 K 1200 R

05 > 06 •

1200 K 1200 R

07 > •

1200 K 1200 R SPORT

07 > •

1200 R 1200 C

03 > •

1200 R 1200 R

07 > 14 •

1200 R 1200 R DARK WHITE

14 > •

1300 K 1300 R

09 > •

1300 K 1300 R DYNAMIC

11 > •

1600 K 1600 GT

11 > •

1600 K 1600 GTL

11 > •





**07GR63.19** 43.9 x 43.20 x 8  
44.7 x 48.9 x 8/9.5

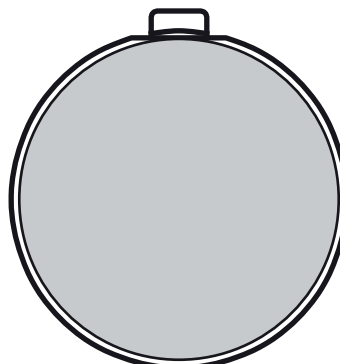
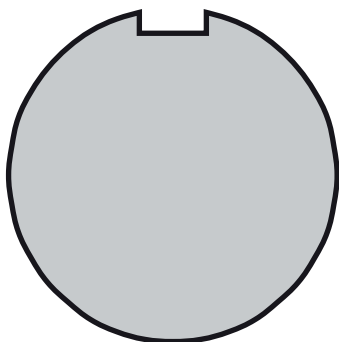

**HYOSUNG**

125 CRUISE CLASSIC	99 >	•
125 CRUISE II	99 >	•
125 F	00 >	•

125 GA	98 >	•
125 GF	98 >	•
125 GS	99 >	•

98 >	•
98 >	•
99 >	•

**SUZUKI**

125 GP ALL MODELS	77 >	•
-------------------	------	---



**07GR64.07** 78.9 x 45.9 x 9  
**07GR64.TT** “ “ “

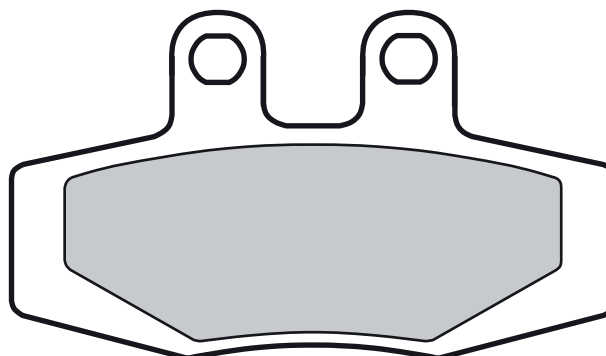

**KTM**

125 EXC	90 > 91	• •
125 GS	88 >	• •
125 GS	89 > 91	• •
125 MX	88 >	• •
250 EXC	90 > 91	• •
250 GS	88 > 93	• •
250 MX	88 > 88	• •

300 EXC	90 > 92	• •
350 EXC	87 > 91	• •
350 GS	87 >	• •
350 MX	87 >	• •
500 MX	88 > 88	• •
550 LC4	87 >	• •
550 MX	87 >	• •
600 EXC	87 > 87	• •

600 EXC	88 >	• •
600 INCAS	89 >	• •
600 MX	87 > 90	• •

**MAICO**

250 GP	89 >	• •
400 GP	89 >	• •
500 GP	89 >	• •



**07GR65.27** 44.2/41.9 x 45.6 x 16  
44.2/41.9 x 45.6 x 10

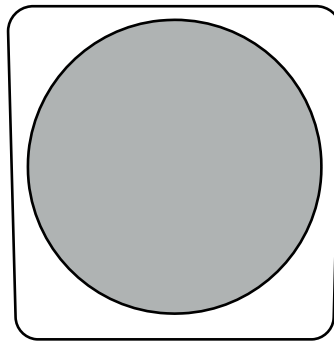
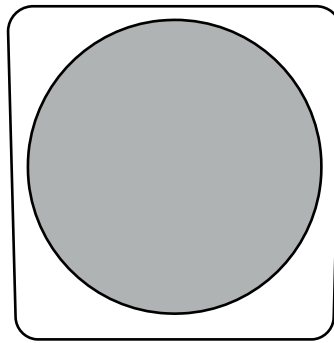

**KAWASAKI**

90 KH	78 >	•
100 KH EX,G	81 > 82	•
400 KZ	78 > 79	•



**07GR66.10** 59.5 x 52 x 10.4

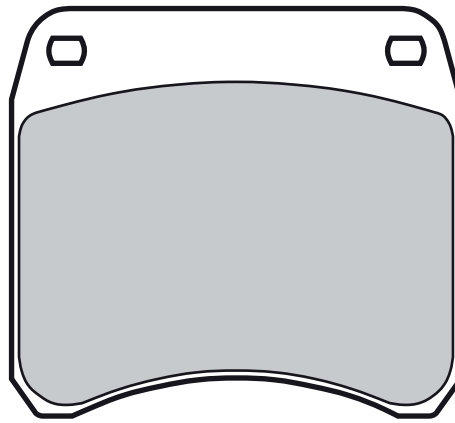

**TRIUMPH**

750	BONNEVILLE T 140 V, E	75 > 80	•	•
750	BONNEVILLE T 140 V, E	81 > 83	•	•

750	THUNDERBIRD TR 65	81 >	•
750	TIGER TR7 R TRIAL	81 >	•
750	TIGER TR7 V	73 > 81	•

750	TRIDENT T 160 V	75 > 77	•	•
750	TSS	82 >	•	•
750	TSX	82 >	•	•



**07GR68.SA** 91.6 x 48.5 x 7.9

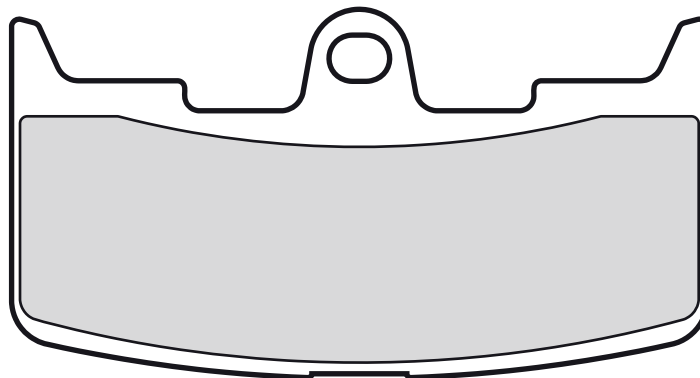

**BUELL**

984	XB9R FIREBOLT	02 >	•
984	XB9S LIGHTNING	03 >	•

984	XB9SX CITY X	05 >	•
1200	XB12 R	04 >	•
1200	XB12 S LIGHTNING	04 > 08	•

1200	XB12 SCG LIGHTNING	04 > 08	•
1200	XB12 STT SUPER TT	07 >	•
1200	XB12 X ULYSSES	06 >	•



<b>07GR69.SD</b>	61.8 x 31.6 x 6.5
<b>07GR69.SX</b>	“ “ “

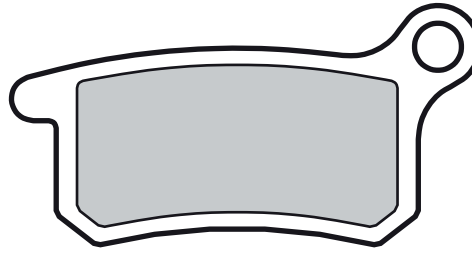
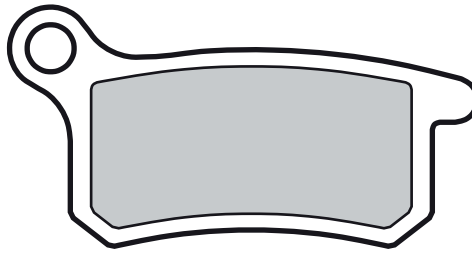

**HUSQVARNA**

65	CR	12 >	•
----	----	------	---



**KTM**

65	SX	02 > 03	•
65	SX	04 > 08	•



65	SX	09 >	• •
85	SX	04 > 10	• •
85	SX	11 > 11	•



**07GR70.SD** 43.3 x 25 x 5  
**07GR70.SX** “ “ “

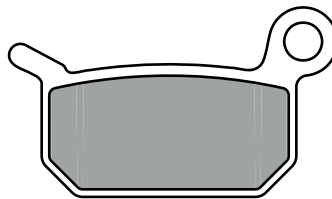
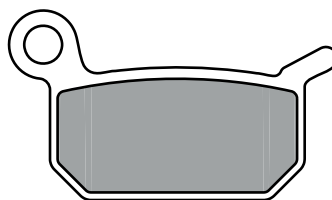

### HUSQVARNA

50	CR PRO SENIOR	06 >	•
50	CR SENIOR	06 >	•
50	SM	10 >	•

### KTM

50	SM SUPERMOTO	06 >	• •
50	SX PRO JUNIOR	02 >	•
50	SX PRO SENIOR	02 > 03	•



50	SX PRO SENIOR	04 >	• •
50	SX PRO SENIOR ADVENTURE	04 >	•
65	SX	04 > 08	•

### LEM

50	CX2	03 >	• •
50	CX3	03 >	• •
50	R2	03 >	• •
50	R3	03 >	• •



50	R3 XC	03 >	• •
50	RX2	03 >	• •
50	RX3	03 >	• •
65	RX	05 >	• •
150	RX	11 >	•

### POLINI

50	X1 R	04 >	• •
50	X3 R	04 >	• •
65	X5 RP	05 >	• •



**07GR71.SD** 44.6 x 50.7 x 7  
**07GR71.SX** “ “ “

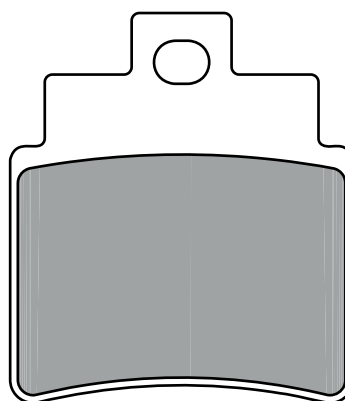

### ARCTIC CAT

250	DVX	06 > 09	•
300	DVX	09 >	•



### GILERA

250	OREGON QUAD	07 >	•
-----	-------------	------	---



### KYMCO

250	KXR	04 >	•
250	KXR (L3/E4/0235)	04 >	•
250	MXU	06 >	•
250	URBAN QUAD	06 >	•
300	MAXXER	06 >	•
300	MAXXER SUPERMOTO	15 >	•



**07GR72.SA** 69.7 x 51.6 x 7.5

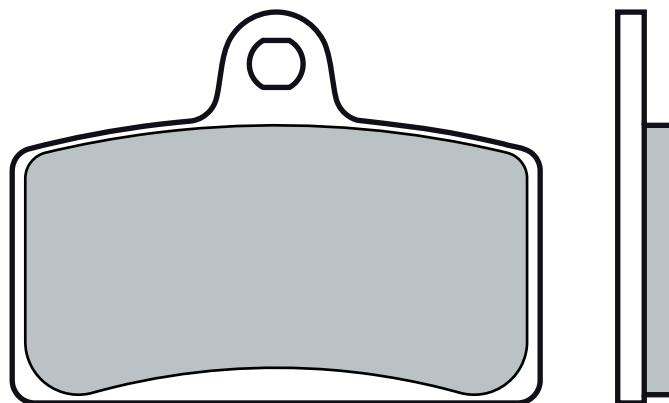

**APRILIA**

125 RS-4	11 > 11	•
125 RS-4	12 >	•

**DERBI**

50 DRD PRO R	06 >	•
50 GPR	09 >	•
50 GPX1	06 >	•
80 GPR CUP	04 >	•

125 GPR	05 >	•
125 GPR NUDE	05 >	•
125 GPR RACING	09 >	•

**GILERA**

125 SC	06 >	•
--------	------	---

**MALAGUTI**

50 DRAGON	05 >	•
-----------	------	---

50 NKD DRAGON	06 >	•
---------------	------	---

**PEUGEOT**

50 XR7	08 >	•
--------	------	---

**RIEJU**

50 RS3 PRO	12 >	•
125 RS3	10 >	•
125 TANGO	06 > 07	•



**07GR73.SD** 62 x 40.7 x 8.3  
82.2 x 40.7 x 8.3

**07GR73.SX** “ “ “

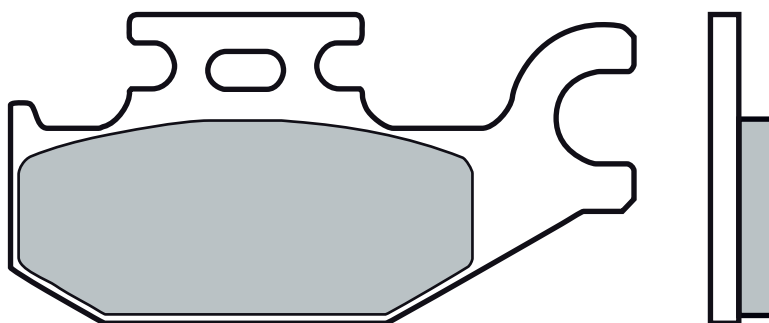
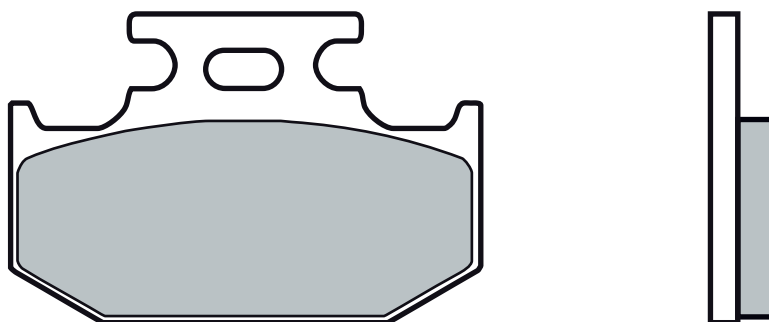

**SUZUKI**

400 KING QUAD KLT-A, KLT-F	08 >	•
----------------------------	------	---

400 KING QUAD LT-A, LT-F	08 >	•
450 KING QUAD LT-A	08 >	•
500 LT-A KING QUAD	11 >	•

700 LT-A KING QUAD	05 >	•
750 KING QUAD LT-A	08 >	•



<b>07GR74.SD</b>	62 x 40.7 x 8.3
	82.2 x 40.7 x 8.3
<b>07GR74.SX</b>	“ “ “

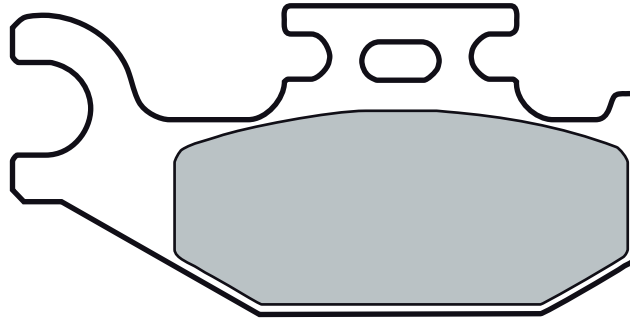
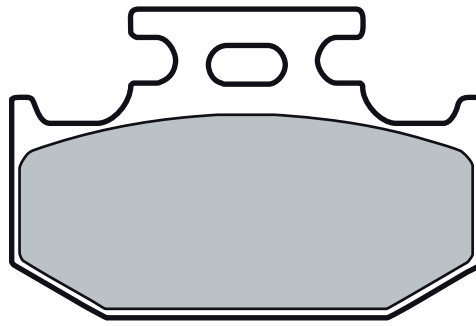

### SUZUKI

400	KING QUAD KLT-A, KLT-F	08 >	•
400	KING QUAD LT-A, LT-F	08 >	•

450	KING QUAD LT-A	08 >	•
500	LT-A KING QUAD	11 >	•
700	LT-A KING QUAD	05 >	•
750	KING QUAD LT-A	08 >	•

### YAMAHA

450	YXR RHINO	06 >	•
700	YFM R RAPTOR left	06 >	•
700	YFM RY left/rear	09 >	•



**07GR75.SA** 76.7 x 49.7 x 8.3

**07GR75.SX** “ “ “

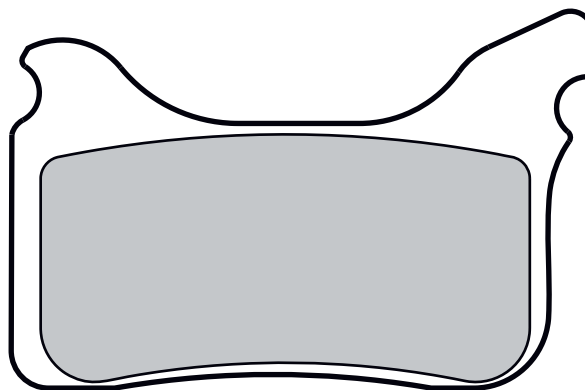
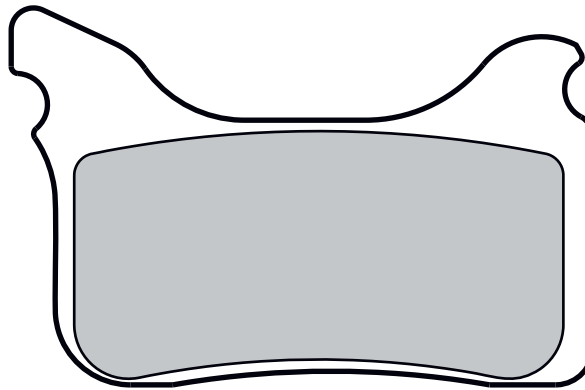

**APRILIA**

450 SXV	06 >	•
550 SXV	06 >	•
660 PEGASO FACTORY	05 >	•

**KTM**

450 SMR	04 > 06	•
525 SMR	05 >	•







<b>07GR76.SA</b>	34.9 x 45.9 x 7.7
<b>07GR76.SX</b>	“ “ “
<b>07GR76.RC</b>	“ “ “

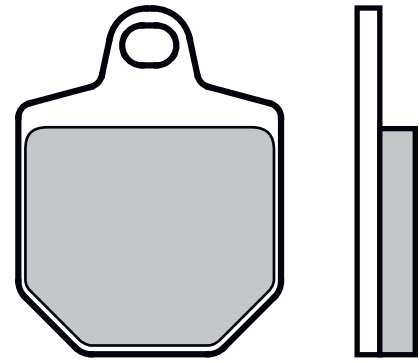

### HM

125	CRM X SUPERMOTARD	07 > 07	•
250	CRM X SUPERMOTARD	07 >	•
450	CRM X SUPERMOTARD	07 >	•

490	CRE FX	07 >	•
500	CRM F SUPERMOTO	11 >	•
500	CRM X SUPERMOTARD	07 > 09	•

### KTM

450	SMR	07 > 12	•
560	SMR	06 >	•



<b>07GR77.07</b>	68.3 x 55.3 x 9.2
<b>07GR77.SA</b>	“ “ “
<b>07GR77.SC</b>	“ “ “

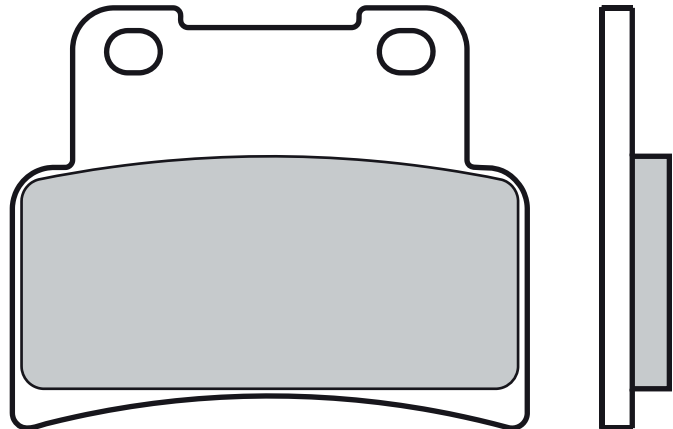

### APRILIA

125	RS	06 >	•
750	DORSODURO	09 >	•
750	DORSODURO ABS	09 >	•
750	SHIVER	07 >	•
750	SHIVER	09 >	•
750	SHIVER ABS	09 >	•

750	SHIVER GT	09 >	•
750	SHIVER GT ABS	09 >	•
750	SHIVER SL	07 >	•
750	SHIVER SL	09 >	•
750	SMV DORSODURO	08 >	•
850	MANA	07 > 07	•
850	MANA	08 >	•
850	MANA GT	09 >	•

### SYM

400	MAXSYM	11 >	•
-----	--------	------	---

### YAMAHA

125	MT	14 >	•
125	YZF R	14 >	•



**07GR78.CC** 103.5 x 42.4 x 9.1

62.5 x 34.1 x 11

**07GR78.SD** “ “ “

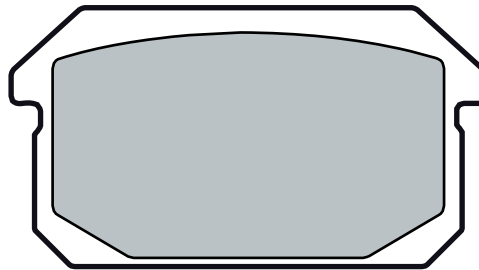
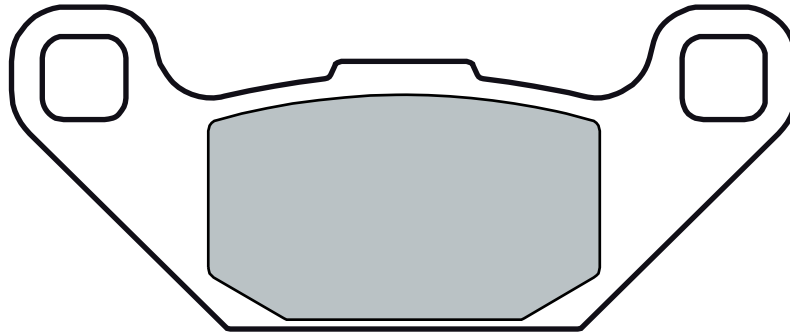

**ADLY**

300 ATV SPORT

07 >



**CPI**

250 XS QUAD

06 >



**QUADZILLA**

250 E 250

06 >



250 XRV, E

06 >





**07GR79.CC** 93.9 x 32.7 x 8

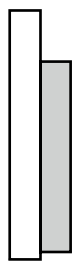
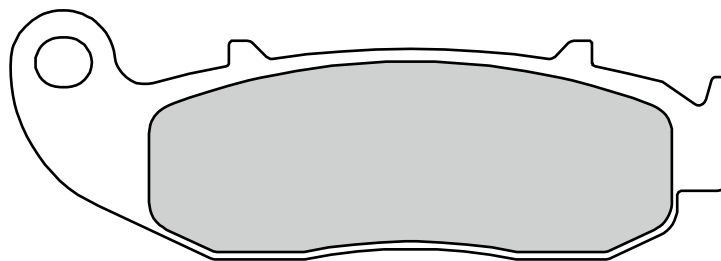
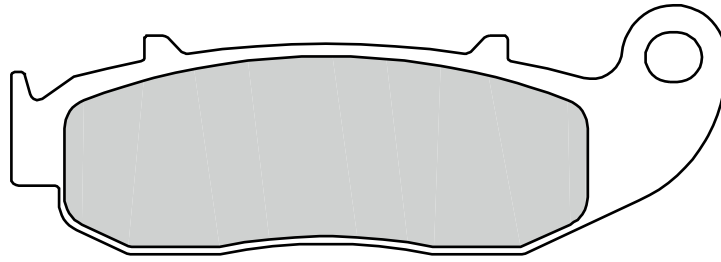

**FANTIC MOTOR**

125	CABALLERO MOTARD	10 >	•
125	CABALLERO REGOLARITÀ	10 >	•
200	CABALLERO MOTARD	10 >	•
200	CABALLERO REGOLARITÀ	10 >	•



**07GR80.CC** 114.3 x 38.6 x 9.5

**07GR80.SA** “ “ “

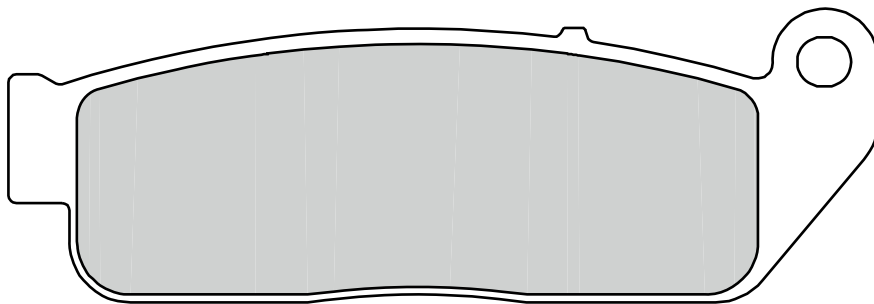
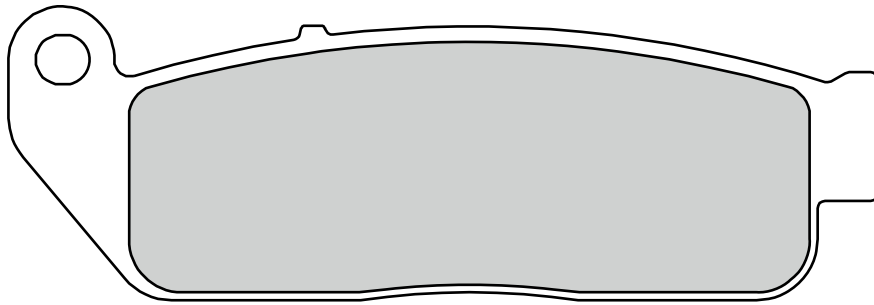

**INDIAN**

1130 SCOUT

15 > •



0821 000 555



0821 000 777



+33 3 89 70 3000



+33 3 89 70 30 99



**07GR81.CC** 93.7 x 45.3 x 8.4  
72.5 x 45.3 x 10.7

**07GR81.SP** “ “ “

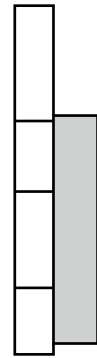
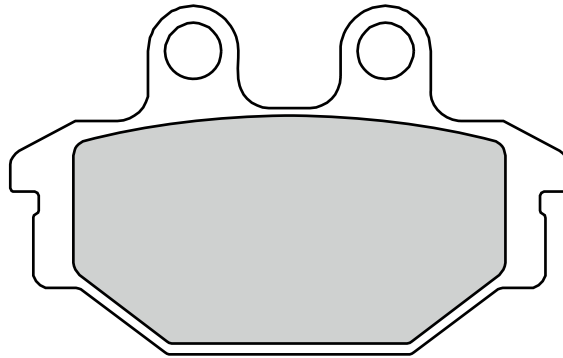
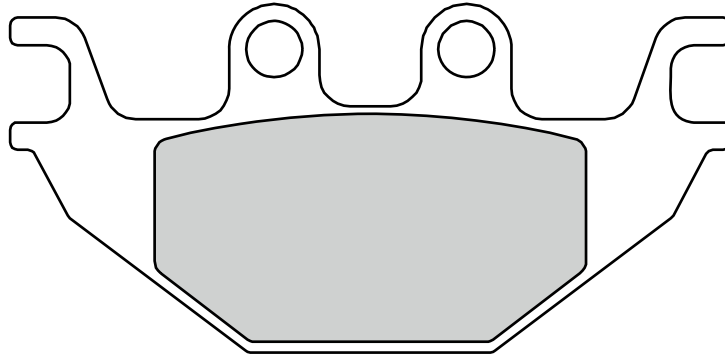

**INDIAN**

1130 SCOUT 15 > •

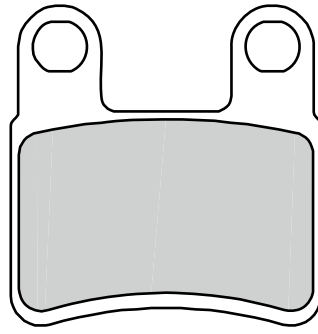
**07GR82.CC** 40.9 x 42.20 x 5.4**KYMCO**

400	MAXXER (PARKING BRAKE)	08 > 10	•
400	MXU (PARKING BRAKE)	08 > 11	•
450	MAXXER (PARKING BRAKE)	10 >	•
450	MXU I	11 >	•
450	MXU I (PARKING BRAKE)	11 >	•

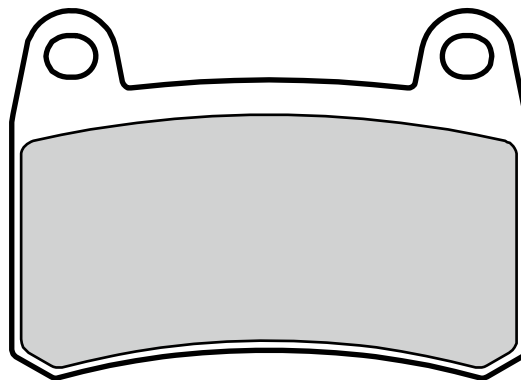
**07GR83.SA** 67.6 x 48.3 x 7**BENELLI**

251	BN 251	15 >	•
300	BN 302	14 >	•
302	TORNADO	16 >	•



**07GR84.CC** 56 x 31.8 x 5  
**07GR84.SX** " " "

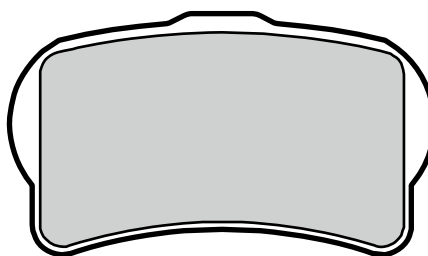

### GAS GAS

125	TXT PRO RACING	14 >	•
125	TXT PRO REPLICA	13 >	•
250	TXT PRO RACING	14 >	•
250	TXT PRO REPLICA	13 >	•
280	TXT PRO RACING	14 >	•
280	TXT PRO REPLICA	13 >	•
300	TXT PRO RACING	14 >	•
300	TXT PRO REPLICA	13 >	•

### JOTAGAS

125	JT	14 >	•
250	JT	14 >	•
280	JT	14 >	•
300	JT	14 >	•

### OSSA

300	TR FACTORY R	15 >	•
-----	--------------	------	---

### VERTIGO

300	COMBAT CAMO WORKS	15 >	•
300	COMBAT ICE HELL	15 >	•
300	COMBAT RR	15 >	•

### MONTESA

260	COTA 4RIDE	16 >	•
260	COTA 4RT RACE REPLICA	15 >	•
300	COTA RR	15 >	•



**07HD01.05** 113.9 x 65.4 x 7.2

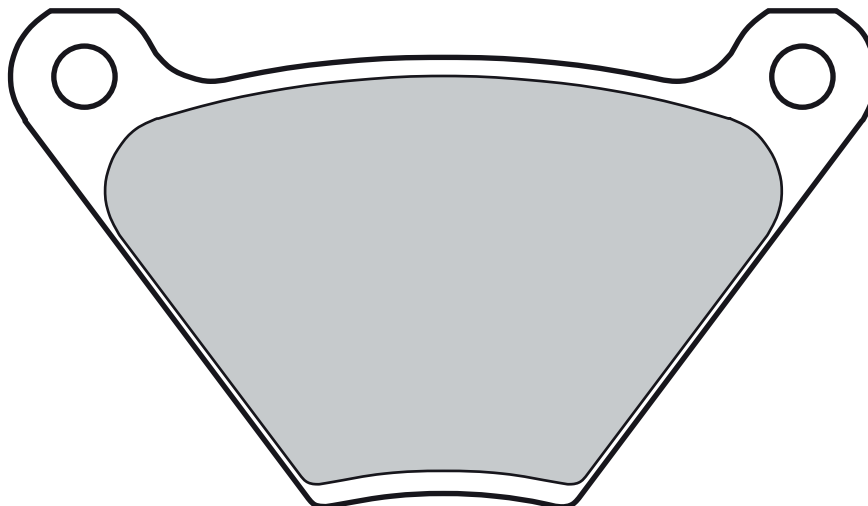

### HARLEY DAVIDSON

1000	XLCH	73 >	•
1200	FL FLH POLICE	75 > 79	• •
1200	FLH	74 > 76	• •
1200	FLH	80 >	•
1200	FLH ANNIVERSARY	78 >	• •
1200	FLH TOURING	77 > 78	• •
1200	FLHS	77 > 80	• •

1200	FX	74 > 80	•
1200	FXE	74 > 80	•
1200	FXS	78 > 79	•
1340	FLH 80	78 > 80	• •
1340	FLH 80	81 >	•
1340	FLH ELECTRA GLIDE	82 > 83	•
1340	FLH ELECTRA GLIDE SPEC.	84 >	•
1340	FXB 80	80 > 81	•

1340	FXB STURGIS	82 >	•
1340	FXE 80	78 > 81	•
1340	FXE SUPER GLIDE	83 > 84	•
1340	FXEF 80 FAT BOB	79 > 81	•
1340	FXR	78 > 81	•
1340	FXS 80	79 > 81	•
1340	FXS LOW RIDER	82 >	•
1340	FXWG 80	80 > 81	•
1340	FXWG WIDE GLIDE	82 >	•



**07HD02.02** 53.4 x 68.8 x 6.5

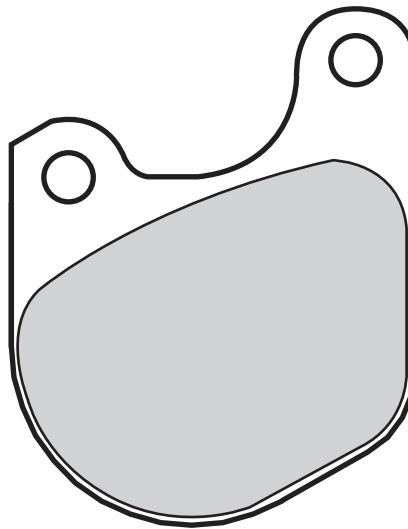

**HARLEY DAVIDSON**

883 XLH 883 SPORTSTER	70 > 83	•
1000 XL	78 >	•
1000 XLCH	78 > 80	•
1000 XLH SPORTSTER	79 > 82	•
1000 XLH SPORTSTER	83 > 85	•
1000 XLS ANNIVERSARY	82 >	•
1000 XLS SPORTSTER	79 > 82	•
1000 XLS SPORTSTER	83 >	•
1000 XLX 61	83 >	•
1000 XLX 61	84 >	•

1000 XR	85 >	•
1200 FX	74 > 80	•
1200 FXE	74 > 80	•
1200 FXS	78 > 79	•
1340 FLTH TOUR GLIDE	84 >	•
1340 FXB 80	80 > 81	•
1340 FXB STURGIS	82 >	•
1340 FXE	82 >	•
1340 FXE 80	78 > 81	•
1340 FXE SUPER GLIDE	83 > 84	•
1340 FXEF 80 FAT BOB	79 > 81	•
1340 FXR	78 > 81	•

1340 FXR 1340 SUPER GLIDE	82 > 83	•
1340 FXRS LOW GLIDE	82 > 84	•
1340 FXRS SUPER GLIDE II	82 > 83	•
1340 FXRT SUPER GLIDE II	83 >	•
1340 FXS 80	79 > 81	•
1340 FXS LOW RIDER	82 >	•
1340 FXSB LOW RIDER	83 >	•
1340 FXWG 80	80 > 81	•
1340 FXWG WIDE GLIDE	82 >	•
1340 FXWG WIDE GLIDE	83 >	•
1340 FXWG WIDE GLIDE	84 >	•



**07HD03.03** 71.1 x 88.9 x 6.6

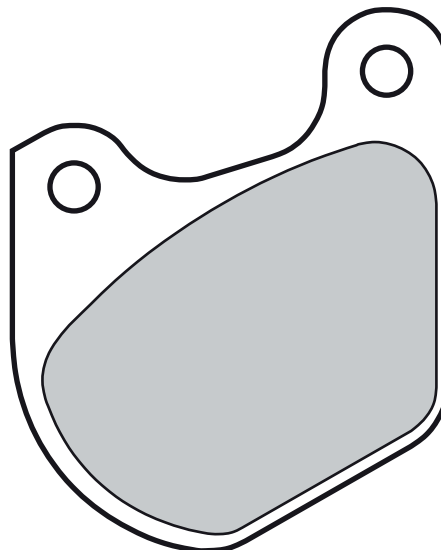

**HARLEY DAVIDSON**

1000 XL	78 >	•
1000 XLCH	78 > 80	•
1000 XLH SPORTSTER	79 > 82	•

1000 XLS SPORTSTER	79 > 82	•
1340 FLH CLASSIC	82 > 83	•
1340 FLH ELECTRA GLIDE	82 > 83	•
1340 FLH HERITAGE	81 >	•

1340 FLT 80	80 > 81	•
1340 FLT 80 CLASSIC	81 >	•
1340 FLT CLASSIC	82 > 83	•
1340 FLT TOUR GLIDE	82 >	•





**07HD04.13** 74.4 x 48.9 x 12

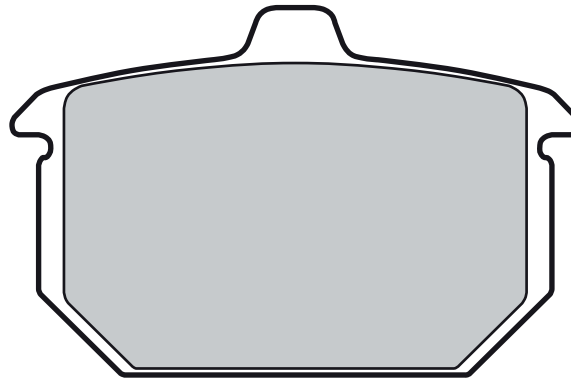

**HARLEY DAVIDSON**

883	XLH 883 SPORTSTER	85 > 86	•
1000	XLH SPORTSTER	83 > 85	•
1000	XLS ANNIVERSARY	82 >	•
1000	XLS SPORTSTER	83 >	•
1000	XLX 61	83 >	•
1000	XLX 61	84 >	•
1000	XR	85 >	•
1100	XLH SPORTSTER	85 > 86	•
1100	XLX	86 >	•
1340	FLHT ELECTRA GLIDE	85 > 86	•

1340	FLHTC ELECTRA GLIDE CLASSIC	85 > 86	•
1340	FLST HERITAGE SOFTAIL	86 > 87	•
1340	FLTC TOUR GLIDE CLASSIC	85 > 86	•
1340	FXE	85 > 86	•
1340	FXR 1340 SUPER GLIDE	82 > 83	•
1340	FXR 1340 SUPER GLIDE	85 > 86	•
1340	FXRD SPORT GLIDE GTE	85 > 86	•
1340	FXRS LOW GLIDE	82 > 84	•

1340	FXRS LOW RIDER	85 > 86	•
1340	FXRS SUPER GLIDE II	82 > 83	•
1340	FXRT 1340 SPORT GLIDE	85 > 86	•
1340	FXRT SUPER GLIDE II	83 >	•
1340	FXSB LOW RIDER	83 >	•
1340	FXST SOFTAIL	84 > 86	•
1340	FXSTC 1340 SOFTAIL CUSTOM	85 > 86	•
1340	FXWG WIDE GLIDE	83 >	•
1340	FXWG WIDE GLIDE	84 >	•
1340	FXWG WIDE GLIDE	85 > 86	•



**07HD05.07** 174.3 x 72.8 x 10.4

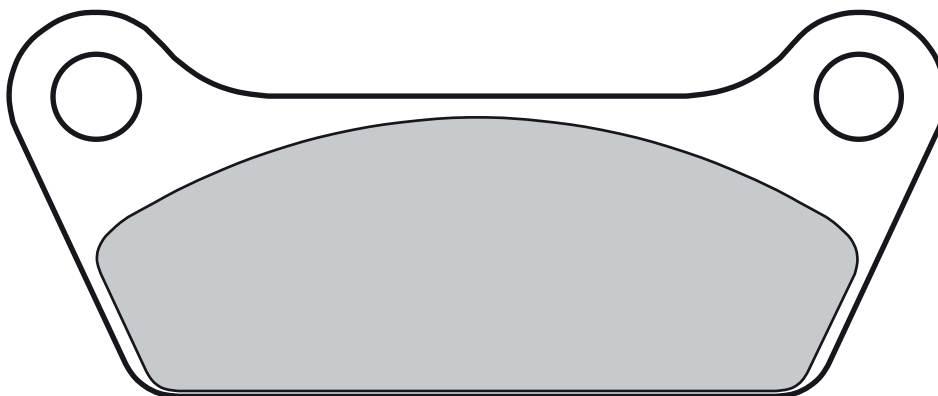

**HARLEY DAVIDSON**

1200	FLH	80 >	•
1340	FLH 80	81 >	•
1340	FLH CLASSIC	82 > 83	•

1340	FLH ELECTRA GLIDE SPEC.	84 >	•
1340	FLH HERITAGE	81 >	•
1340	FLT	84 > 85	•

1340	FLT 80	80 > 81	•
1340	FLT 80 CLASSIC	81 >	•
1340	FLT CLASSIC	82 > 83	•
1340	FLT TOUR GLIDE	82 >	•
1340	FLTH TOUR GLIDE	84 >	•



**07HD06.14** 59.3 x 61.5 x 13

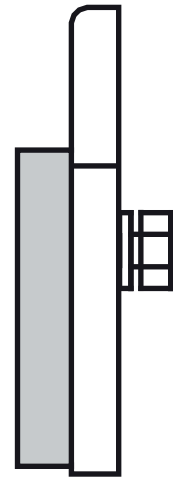
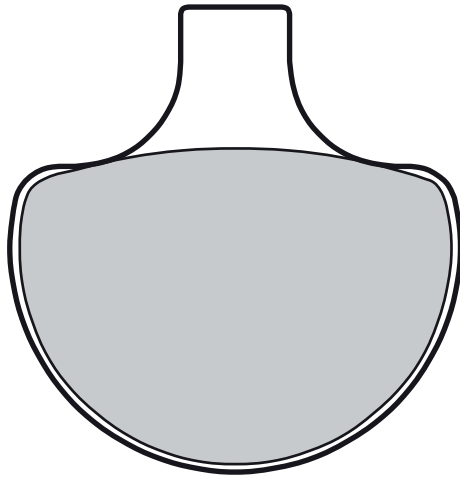

### HARLEY DAVIDSON

883	XLH 883 SPORTSTER	85 > 86	•
883	XLH 883 SPORTSTER	87 > 89	•
883	XLH 883 SPORTSTER	90 > 99	•
1100	XLH	87 > 88	•
1100	XLH SPORTSTER	85 > 86	•
1100	XLX	86 >	•
1200	XLH 1200 SPORTSTER	90 > 99	•
1340	FLHS ELECTRA GLIDE SPORT	90 >	•
1340	FLHT ELECTRA GLIDE	85 > 86	•
1340	FLHT ELECTRA GLIDE CLASSIC	87 > 99	•
1340	FLHTC ELECTRA GLIDE CLASSIC	85 > 86	•
1340	FLHTC ELECTRA GLIDE CLASSIC	90 > 99	•
1340	FLHTC ELECTRA GLIDE CLASSIC	93 >	•
1340	FLHTC ULTRA CLASSIC	90 > 99	•
1340	FLST HERITAGE SOFTAIL	86 > 87	•
1340	FLST HERITAGE SOFTAIL	88 > 99	•
1340	FLSTC HERITAGE SOFTAIL CLASSIC	90 > 99	•
1340	FLSTF FAT BOY	90 > 99	•

1340	FLSTN HERITAGE SOFTAIL NOST.	93 > 99	•
1340	FLT	84 > 85	•
1340	FLTC TOUR GLIDE CLASSIC	85 > 86	•
1340	FLTC TOUR GLIDE CLASSIC	90 >	•
1340	FXDB DYNA GLIDE DAYTONA	91 > 99	•
1340	FXDB DYNA GLIDE STURGIS	91 > 99	•
1340	FXDB STURGIS	91 > 99	•
1340	FXDL DYNA LOW RIDER	93 > 99	•
1340	FXDWG DYNA WIDE GLIDE	93 > 99	•
1340	FXE	85 > 86	•
1340	FXLR 1340 LOW RIDER CUSTOM	87 > 88	•
1340	FXLR 1340 LOW RIDER CUSTOM	93 > 99	•
1340	FXR	87 > 88	•
1340	FXR 1340 SUPER GLIDE	85 > 86	•
1340	FXR 1340 SUPER GLIDE	90 > 99	•
1340	FXRD SPORT GLIDE GTE	85 > 86	•
1340	FXRS LOW RIDER	85 > 86	•
1340	FXRS LOW RIDER SPORT	87 > 99	•

1340	FXRS LOW RIDER SPORT	90 > 99	•
1340	FXRS LOW RIDER, CONVERT.	90 > 99	•
1340	FXRT 1340 SPORT GLIDE	85 > 86	•
1340	FXRT 1340 SPORT GLIDE	90 > 99	•
1340	FXST SOFTAIL	84 > 86	•
1340	FXSTC 1340 SOFTAIL CUSTOM	85 > 86	•
1340	FXSTC 1340 SOFTAIL CUSTOM	88 > 99	•
1340	FXSTS 1340 SPRINGER SOFTAIL	90 > 99	•
1340	FXWG	87 > 88	•
1340	FXWG WIDE GLIDE	85 > 86	•
1450	FLSTS/I HERITAGE SPRINGER	00 > 03	•
1450	FLSTSC/I SPRINGER SOFTAIL CLASSIC	05 >	•
1450	FXSTS/I SOFTAIL	05 > 05	•
1450	FXSTS/I SOFTAIL	06 > 06	•
1450	FXSTS/I SPRINGER SOFTAIL	00 > 06	•
1584	FLSTSC/I SOFTAIL	07 > 07	•



**07HD07.SP** 127.1 x 50.8 x 7.4

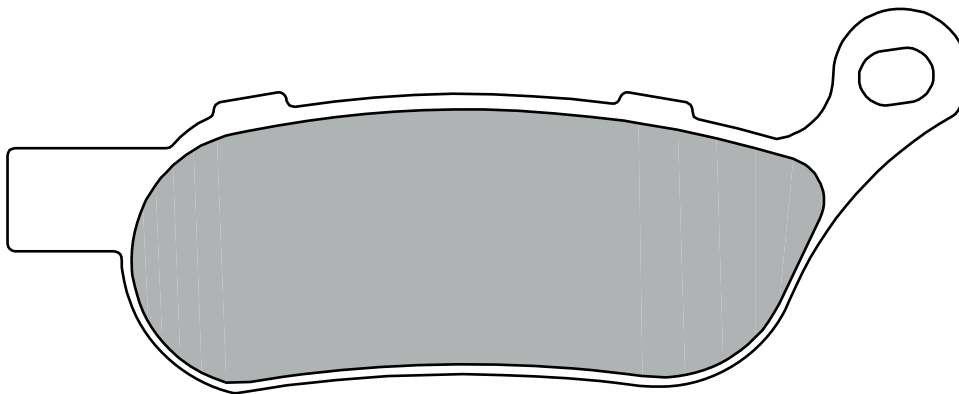
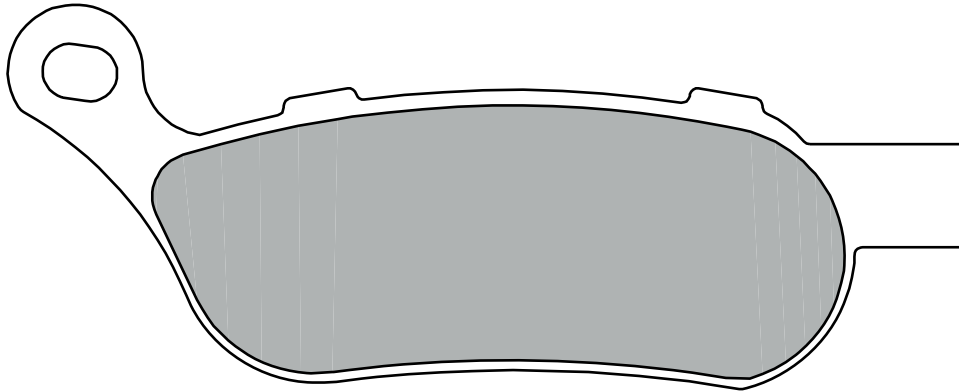

### HARLEY DAVIDSON

1584	FLSTC HERITAGE SOFTAIL CLASSIC	08 >	•
1584	FLSTF FAT BOY	08 >	•
1584	FLSTFB FAT BOY SPECIAL	10 >	•
1584	FLSTN SOFTAIL DELUXE	08 >	•
1584	FXCW ROCKER	08 >	•
1584	FXCWC ROCKER C	08 >	•
1584	FXD DYNA SUPER GLIDE	08 >	•
1584	FXDB DYNA STREET BOB	08 >	•

1584	FXDC DYNA SUPER GLIDE CUSTOM	08 >	•
1584	FXDF FAT BOB	08 >	•
1584	FXDL DYNA LOW RIDER	08 >	•
1584	FXDWG DYNA WIDE GLIDE	08 >	•
1584	FXST/SOFTAIL STANDARD	08 >	•
1584	FXSTB NIGHT TRAIN	08 >	•
1584	FXSTC SOFTAIL CUSTOM	08 >	•
1690	BLACKLINE	13 >	•
1690	DYNA STREET BOB	14 >	•

1690	DYNA SUPER GLIDE CUSTOM	14 >	•
1690	FAT BOY	12 >	•
1690	FAT BOY SPECIAL	12 >	•
1690	FLSTC HERITAGE SOFTAIL CLASSIC	16 >	•
1690	FXDB STREET BOB	16 >	•
1690	FXDF FAT BOB	16 >	•
1690	SOFTAIL DELUXE	12 >	•
1690	SWITCHBACK	12 >	•
1801	FLSS SOFTAIL SLIM S	16 >	•
1801	FLSTFBS FAT BOY S	16 >	•
1802	CVO BREAKOUT	13 >	•
1802	CVO SOFTAIL DELUXE	14 >	•



**07HD08.SP** 46 x 49.5 x 7

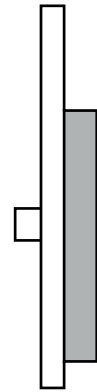
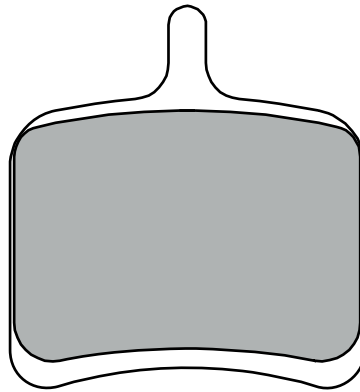

**BUELL**

1125 CR	09 >	•
1125 R	08 >	•

**EBR**

1190 RX	12 >	•
1190 SX	14 >	•



**07HD09.10** 104.1 x 62 x 11.5

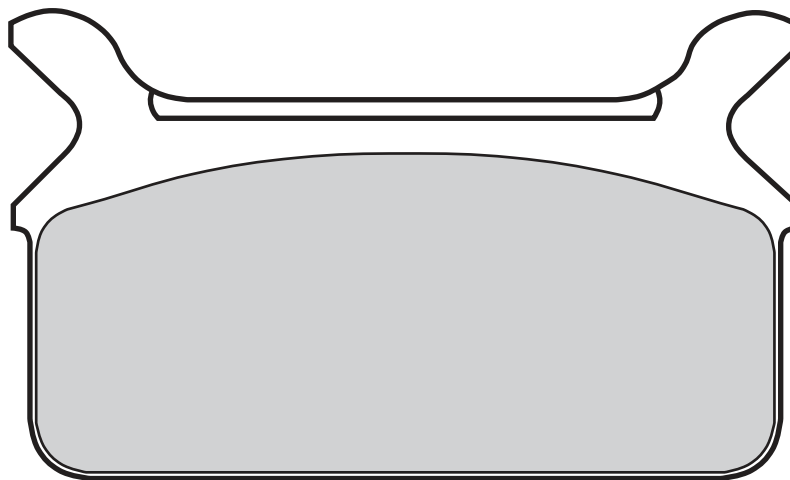

**HARLEY DAVIDSON**

1340	FLHS ELECTRA GLIDE SPORT	90 >	•
1340	FLHTC ELECTRA GLIDE CLASSIC	90 > 99	•
1340	FLHTC ULTRA CLASSIC	90 > 99	•
1340	FLST HERITAGE SOFTAIL	88 > 99	•
1340	FLTC TOUR GLIDE CLASSIC	90 >	•



**07HD10.11** 104.1 x 62 x 11.3

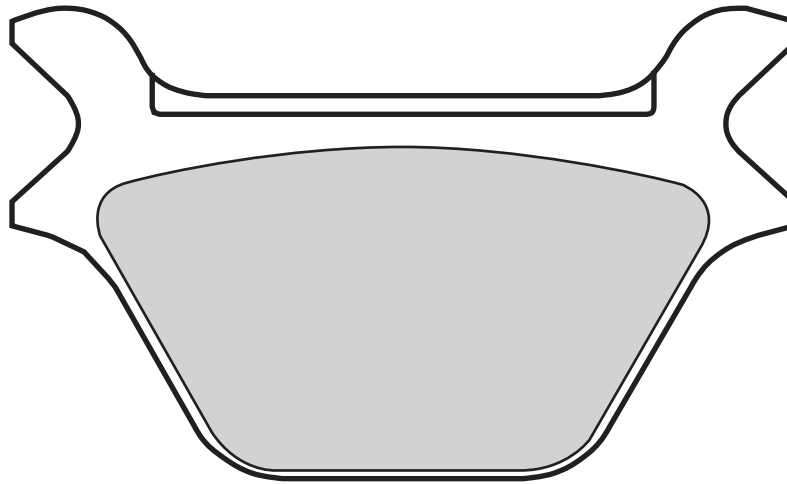

### HARLEY DAVIDSON

883	XLH 883 SPORTSTER	87 > 89	•
883	XLH 883 SPORTSTER	90 > 99	•
1100	XLH	87 > 88	•
1200	XLH 1200 SPORTSTER	90 > 99	•
1340	FLHT ELECTRA GLIDE CLASSIC	87 > 99	•
1340	FLHTC ELECTRA GLIDE CLASSIC	93 >	•
1340	FLSTC HERITAGE SOFTAIL CLASSIC	90 > 99	•
1340	FLSTF FAT BOY	90 > 99	•
1340	FLSTN HERITAGE SOFTAIL NOST.	93 > 99	•

1340	FXDB DYNA GLIDE DAYTONA	91 > 99	•
1340	FXDB DYNA GLIDE STURGIS	91 > 99	•
1340	FXDB STURGIS	91 > 99	•
1340	FXDL DYNA LOW RIDER	93 > 99	•
1340	FXDWG DYNA WIDE GLIDE	93 > 99	•
1340	FXE	82 >	•
1340	FXLR 1340 LOW RIDER CUSTOM	87 > 88	•
1340	FXLR 1340 LOW RIDER CUSTOM	93 > 99	•
1340	FXR	87 > 88	•

1340	FXR 1340 SUPER GLIDE	90 > 99	•
1340	FXRS LOW RIDER SPORT	87 > 99	•
1340	FXRS LOW RIDER SPORT	90 > 99	•
1340	FXRS LOW RIDER, CONVERT.	90 > 99	•
1340	FXRT 1340 SPORT GLIDE	90 > 99	•
1340	FXSTC 1340 SOFTAIL CUSTOM	88 > 99	•
1340	FXSTS 1340 SPRINGER SOFTAIL	90 > 99	•
1340	FXWG	87 > 88	•



**07HD11.09** 111.9 x 56.2 x 10.9

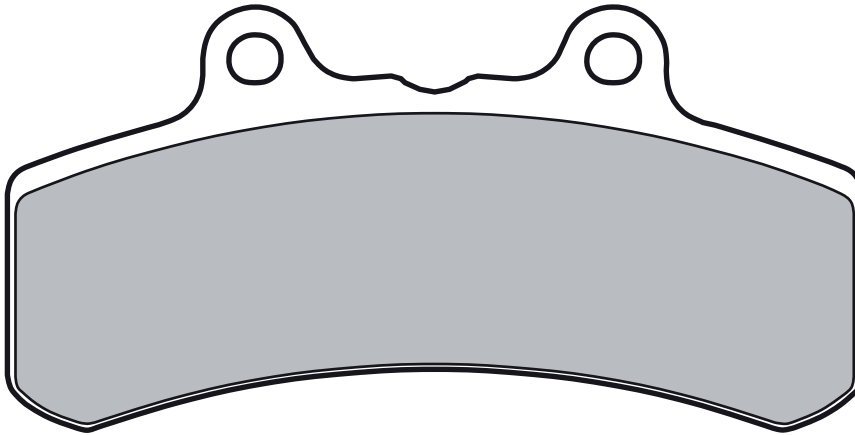

**BUELL**

1200 M2	97 > 97	•
1200 RS	93 >	•



0821 000 555



0821 000 777



+33 3 89 70 3000



+33 3 89 70 30 99



**07HD13.SA** 101.6 x 38.6 x 8.9

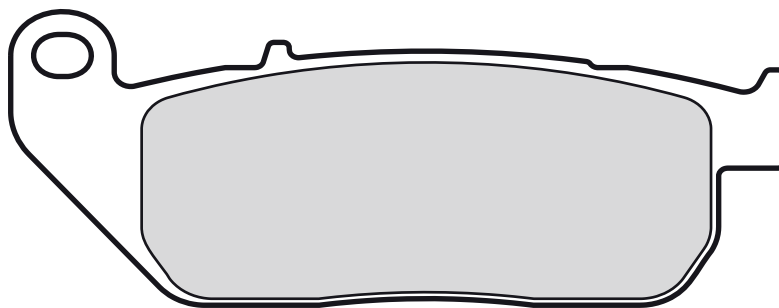
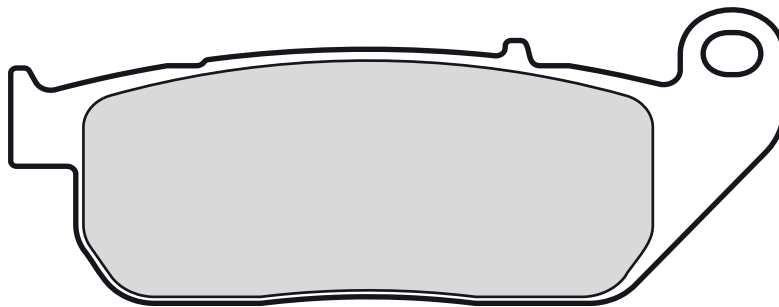

**HARLEY DAVIDSON**

883	XL 883 R ROADSTER	10 >	•
883	XL 883 SPORTSTER	04 >	•
883	XL C SPORTSTER CUSTOM	04 >	•

883	XL L SPORTSTER LOW	06 >	•
883	XL L SUPER LOW	11 >	•
883	XL N IRON	13 > 13	•
1200	XL 1200 R SPORTSTER ROADSTER	04 >	•

1200	XL C SPORTSTER CUSTOM	04 > 13	•
1200	XL N NIGHTSTER	07 >	•
1200	XL V SEVENTY-TWO	11 >	•
1200	XL X FORTY EIGHT	11 >	•



**07HD14.SP** 85.7 x 44.3 x 10

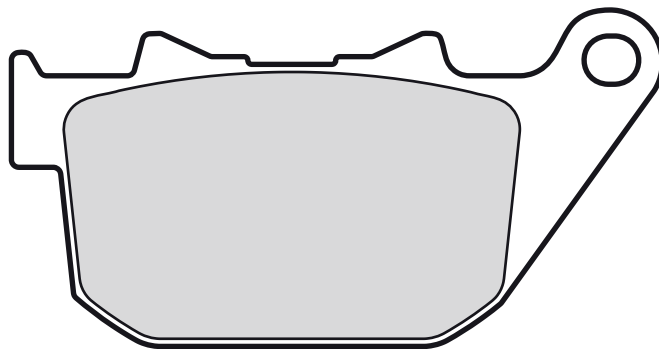
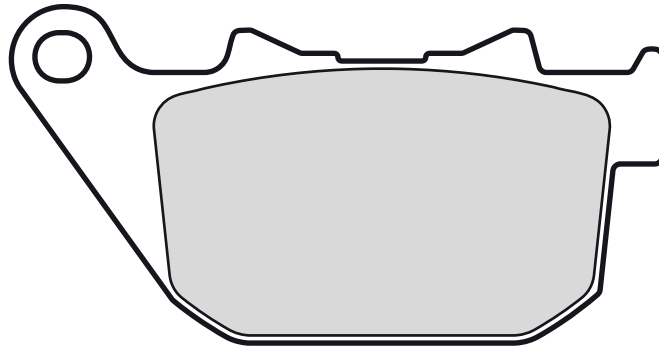

**HARLEY DAVIDSON**

883	XL 883 R ROADSTER	10 >	•
883	XL 883 SPORTSTER	04 >	•
883	XL C SPORTSTER CUSTOM	04 >	•
883	XL L SPORTSTER LOW	06 >	•

883	XL L SUPER LOW	11 >	•
883	XL N IRON	13 > 13	•
1200	XL 1200 R SPORTSTER ROADSTER	04 >	•
1200	XL C SPORTSTER CUSTOM	04 > 13	•

1200	XL N NIGHTSTER	07 >	•
1200	XL V SEVENTY-TWO	11 >	•
1200	XL X FORTY EIGHT	11 >	•
1200	XR	08 >	•
1200	XR 1200 X	10 >	•







**07HD15.SA** 88.6 x 61.8 x 8

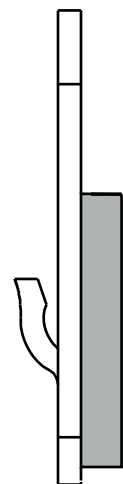
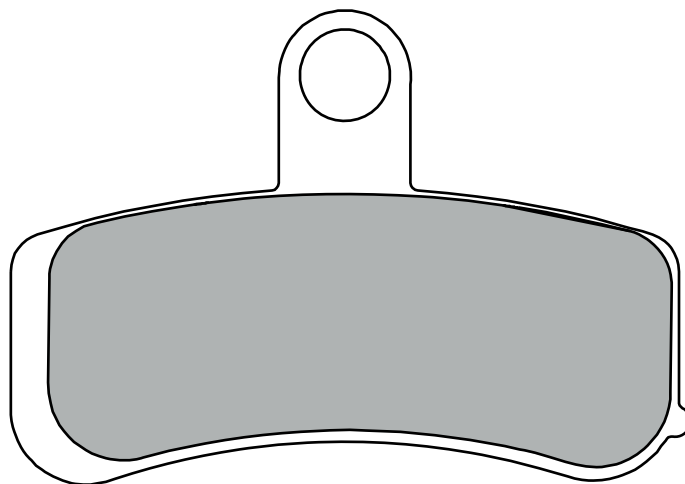
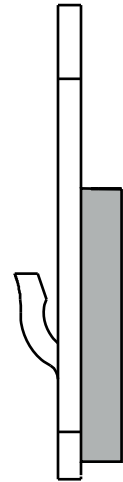
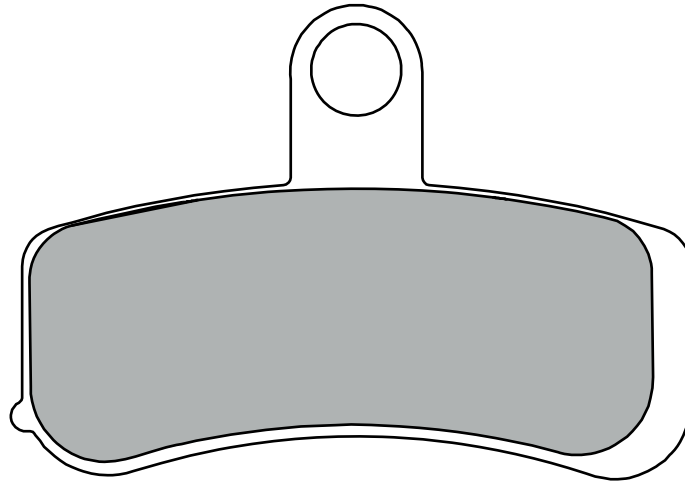

### HARLEY DAVIDSON

1584	FLSTC HERITAGE SOFTAIL CLASSIC	08 >	•
1584	FLSTF FAT BOY	08 >	•
1584	FLSTFB FAT BOY SPECIAL	10 >	•
1584	FLSTN SOFTAIL DELUXE	08 >	•
1584	FXCW ROCKER	08 >	•
1584	FXCWC ROCKER C	08 >	•
1584	FXD DYNA SUPER GLIDE	08 >	•
1584	FXDB DYNA STREET BOB	08 >	•

1584	FXDC DYNA SUPER GLIDE CUSTOM	08 >	•
1584	FXDF FAT BOB	08 >	•
1584	FXDL DYNA LOW RIDER	08 >	•
1584	FXDWG DYNA WIDE GLIDE	08 >	•
1584	FXST/SOFTAIL STANDARD	08 >	•
1584	FXSTB NIGHT TRAIN	08 >	•
1584	FXSTC SOFTAIL CUSTOM	08 >	•
1690	BLACKLINE	13 >	•

1690	DYNA STREET BOB	14 >	•
1690	DYNA SUPER GLIDE CUSTOM	14 >	•
1690	FAT BOY	12 >	•
1690	FAT BOY SPECIAL	12 >	•
1690	FXDB STREET BOB	16 >	•
1690	FXDF FAT BOB	16 >	•
1690	SOFTAIL DELUXE	12 >	•
1690	SWITCHBACK	12 >	•
1802	CVO BREAKOUT	13 >	•
1802	CVO SOFTAIL DELUXE	14 >	•



**07HD16.CC** 97.3 x 63.4 x 8  
**07HD16.SA** “ “ “

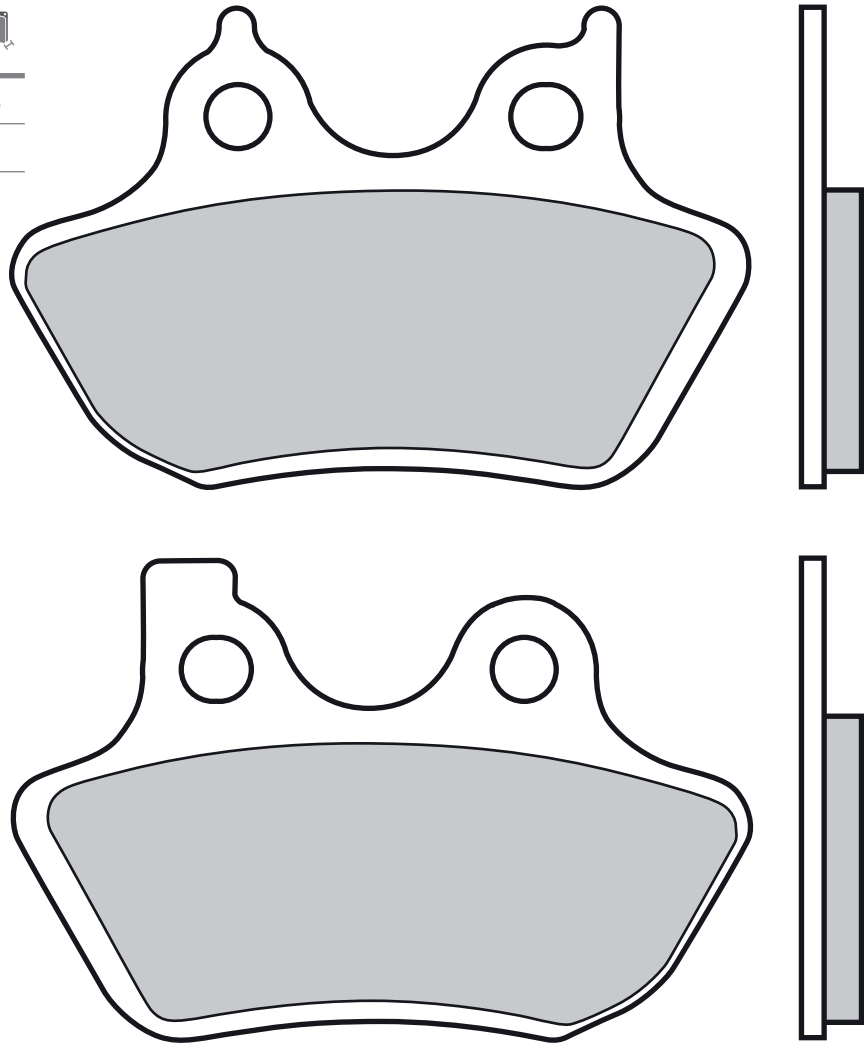

### HARLEY DAVIDSON

883	XL 883 R SPORTSER	00 > 03	• •	1450	FLHT/ ELECTRA GLIDE STANDARD	00 > 04	• •	1450	FLSTN/ SOFTAIL DELUXE	05 >	• •
883	XL 883 SPORTSTER CUSTOM	00 > 03	• •	1450	FLHT/ ELECTRA GLIDE STANDARD	05 > 06	• •	1450	FLSTS/ HERITAGE SPRINGER	00 > 03	•
883	XLH 883 SPORTSTER	00 > 03	• •	1450	FLHTC/ ELECTRA GLIDE CLASSIC	00 > 04	• •	1450	FLSTSC/ SPRINGER SOFTAIL CLASSIC	05 >	•
883	XLH 883 SPORTSTER HUGGER	00 > 03	• •	1450	FLHTC/ ELECTRA GLIDE CLASSIC	05 > 06	• •	1450	FLTR/ ROAD GLIDE CLASSIC	00 > 06	• •
1130	VRSCA V-ROD	02 > 05	• •	1450	FLHTCUI ULTRA			1450	FXD DYNA SUPER GLIDE	00 > 03	• •
1130	VRSCB V-ROD	04 >	• •	1450	CLASSIC ELECTRA GLIDE	00 > 04	• •	1450	FXDBI DYNA STREET BOB	06 >	• •
1200	XL SPORTSTER CUSTOM	00 > 03	• •	1450	FLHTCUI ULTRA			1450	FXDC/ DYNA SUPER GLIDE CUSTOM	05 > 06	• •
1200	XL SPORTSTER SPORT	00 > 03	• •	1450	CLASSIC ELECTRA GLIDE	05 > 06	• •	1450	FXDI 35TH		
1200	XLH 1200 SPORTSTER	00 > 03	• •	1450	FLHTCUI ULTRA			1450	ANNIVERSARY SUPER GLIDE	06 >	•
1450	FLHR/ ROAD KING	00 > 04	• •	1450	FLSTC HERITAGE	00 > 04	• •	1450	FXDI DYNA SUPER GLIDE	04 >	• •
1450	FLHR/ ROAD KING CLASSIC	00 > 04	• •	1450	SOFTAIL CLASSIC	00 > 04	• •	1450	FXDI DYNA SUPER GLIDE	05 > 06	• •
1450	FLHRCI ROAD KING CLASSIC	05 > 06	• •	1450	FLSTC SOFTAIL	06 > 07	• •	1450	FXDL DYNA LOW RIDER	00 > 03	• •
1450	FLHRS/ ROAD KING CUSTOM	04 > 04	• •	1450	FLSTCI SOFTAIL	06 > 06	• •	1450	FXDLI DYNA LOW RIDER	04 >	• •
1450	FLHRS/ ROAD KING CUSTOM	05 > 06	• •	1450	FLSTF FAT BOY	06 > 07	• •	1450	FXDS DYNA CONVERTIBLE	00 > 02	• •
				1450	FLSTF/ FAT BOY	00 > 04	• •				
				1450	FLSTF/ FAT BOY	05 >	• •				
				1450	FLSTI HERITAGE SOFTAIL	06 >	•				



1450 FXDWG DYNA WIDE GLIDE 00 > 03 • •

1450 FXDWGI DYNA WIDE GLIDE 04 > 06 • •

1450 FXDX DYNA SUPER GLIDE SPORT 00 > 03 • •

1450 FXDXI DYNA SUPER GLIDE SPORT 04 > 06 • •

1450 FXDXT DYNA SUPER GLIDE T-SPORT 00 > 03 • •

1450 FXST SOFTAIL STANDARD 00 > 05 • •

1450 FXST SOFTAIL STANDARD 06 > •

1450 FXSTB/I NIGHT TRAIN 00 > 05 • •

1450 FXSTB/I NIGHT TRAIN 06 > •

1450 FXSTD/I SOFTAIL DUECE 00 > 05 • •

1450 FXSTD/I SOFTAIL DUECE 06 > •

1450 FXSTS/I SOFTAIL 05 > 05 •

1450 FXSTS/I SPRINGER SOFTAIL 00 > 06 •

1584 FXSTD SOFTAIL DEUCE 07 > 07 •



**07HD18.CC** 97.5 x 63.6 x 8

**07HD18.SP** “ “ “

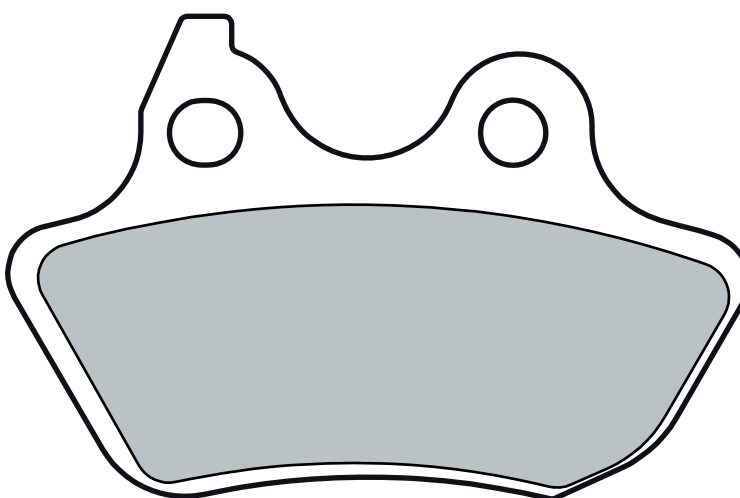
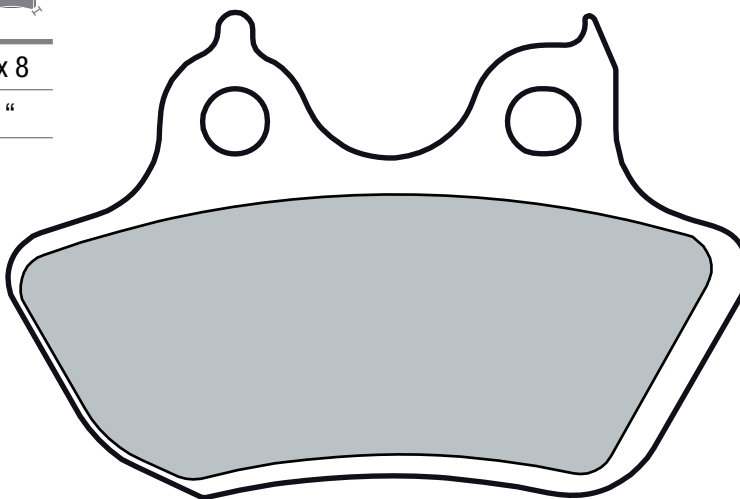

**HARLEY DAVIDSON**

1450 FLSTI HERITAGE SOFTAIL 06 > •

FXDI 35TH  
1450 ANNIVERSARY SUPER GLIDE 06 > •  
1450 FXST SOFTAIL STANDARD 06 > •

1450 FXSTB/I NIGHT TRAIN 06 > •  
1450 FXSTD/I SOFTAIL DUECE 06 > •  
1450 FXSTS/I SOFTAIL 06 > 06 •  
1584 FLSTSC/I SOFTAIL 07 > 07 •  
1584 FXSTD SOFTAIL DEUCE 07 > 07 •





**07HD19.SA** 61 x 46.5 x 7.3  
**07HD19.SC** " " "

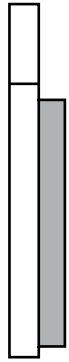
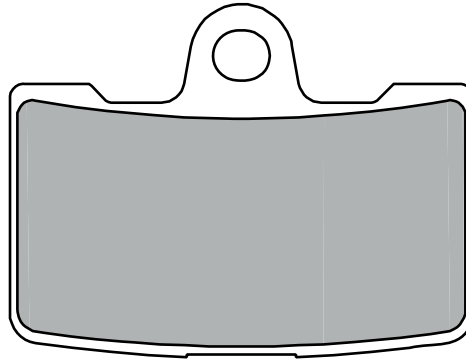

**BUELL**

1125 CR	09 >	•
1125 R	08 >	•

1200 XB12 R FIREBOLT	09 >	•
1200 XB12 S LIGHTNING	09 >	•
1200 XB12 SCG LIGHTNING	09 >	•

**EBR**

1190 RX	12 >	•
1190 SX	14 >	•



**07HD20.SA** 74.5 x 55.2 x 9.2

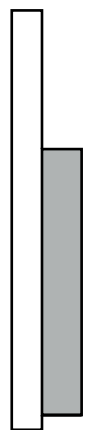
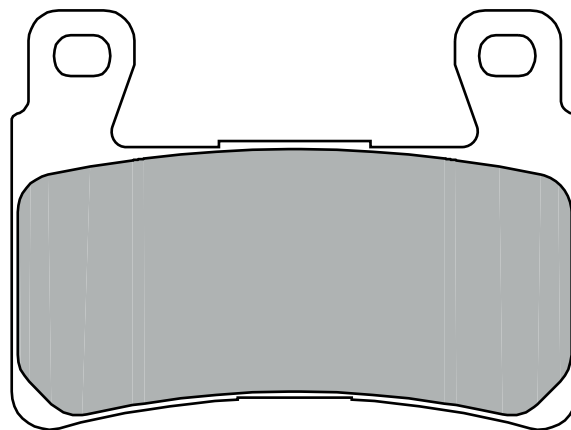

**HARLEY DAVIDSON**

1200 XR	08 >	•
---------	------	---

1200 XR 1200 X	10 >	•
1690 FLSTC HERITAGE SOFTAIL CLASSIC	16 >	•

1801 FLSS SOFTAIL SLIM S	16 >	•
1801 FLSTFBS FAT BOY S	16 >	•



<b>07HD21.CC</b>	94 x 36.2 x 7.6
<b>07HD21.SA</b>	“ “ “
<b>07HD21.SP</b>	“ “ “

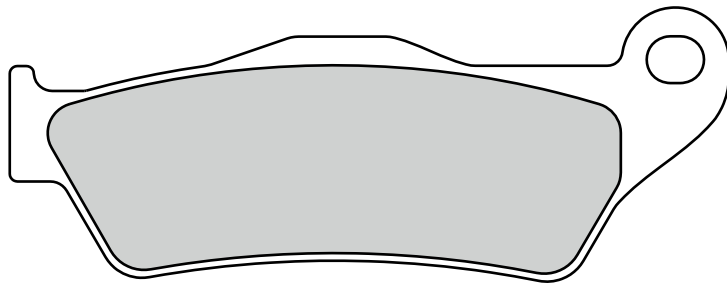
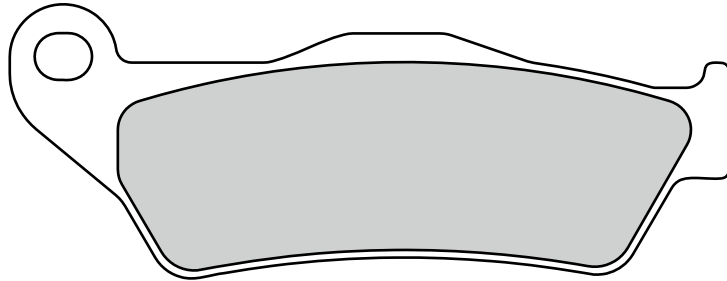

**HARLEY DAVIDSON**

500 STREET	14 >	• •
750 STREET	14 >	• •



**07HD22.CC** 118 x 48.5 x 9.2

**07HD22.SA** “ “ “

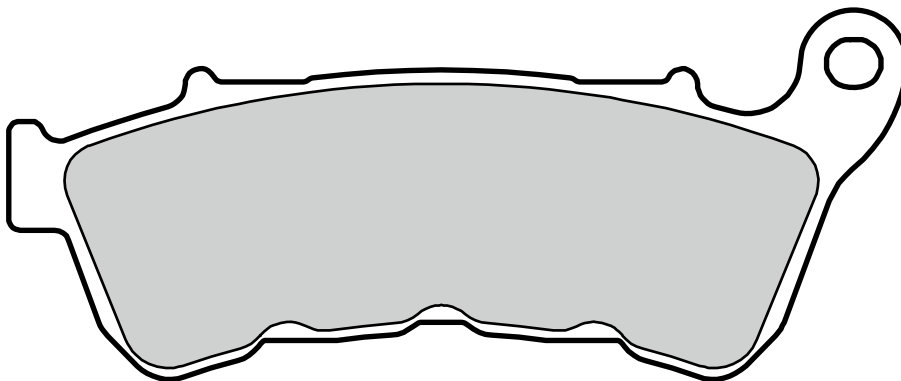
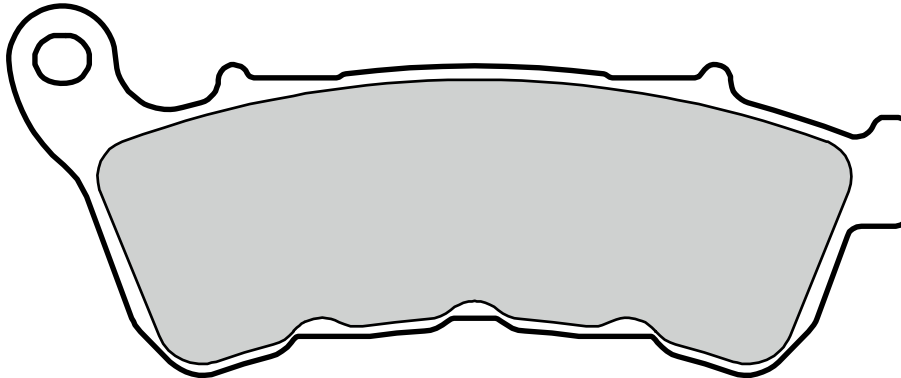

**HARLEY DAVIDSON**

883	XL L SUPER LOW	14 >	•
883	XL N IRON	14 >	•
883	XL N IRON DARK CUSTOM	16 >	•
883	XL R ROADSTER	14 >	•

1200	XL C SPORTSTER CUSTOM	14 >	•
1200	XL CA SPORTSTER CUSTOM	14 >	•
1200	XL CB SPORTSTER CUSTOM	14 >	•

1200	XL CP SPORTSTER CUSTOM	14 >	•
1200	XL T SUPER LOW	15 >	•
1200	XL V SEVENTY-TWO	14 >	•
1200	XL X FORTY EIGHT	14 >	•





**07H001.30** 51.6 x 51.6 x 19.5  
52 x 52 x 13.7

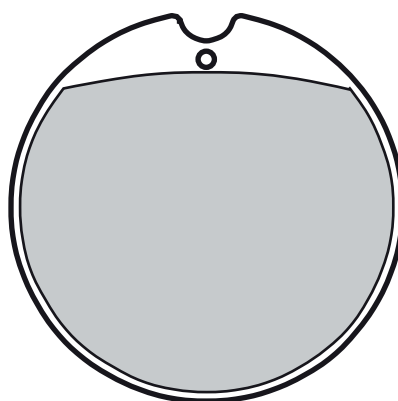
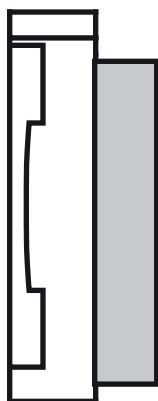
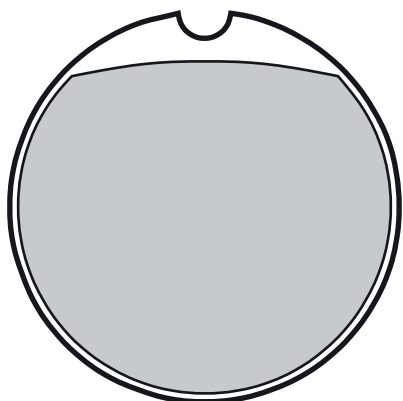

**HONDA**

250 CB	71 > 87	•
250 CB G,T	74 > 76	•
250 CJ T	76 > 78	•
350 CB F, F1	73 > 76	•

360 CB G, T	73 > 76	•
360 CJ T	76 > 78	•
360 CL K1	74 >	•
400 CB F, F1, F2	75 > 79	•
450 CB K5, K6, K7	72 > 77	•
500 CB F	72 > 75	•

500 CB K1, K2, K3	72 > 77	•
500 CB T, T1	75 > 78	•
550 CB F1, F2	75 > 79	•
550 CB K2, K3	74 > 78	•
750 CB A, K	76 > 77	•
750 CB F1	75 > 77	•



**07H002.29** 49.9 x 49.9 x 20  
49.9 x 49.9 x 13.5

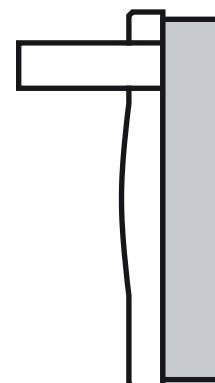
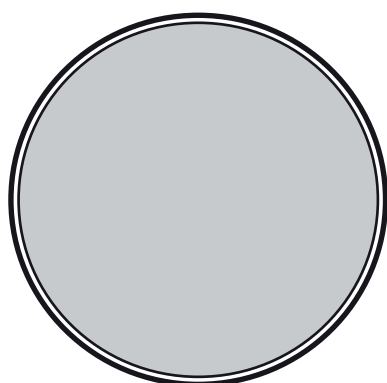

**HONDA**

450 CB K3, K4	71 > 72	•
750 CB K	70 > 76	•





**07H003.07** 66.9 x 49.1 x 9.5

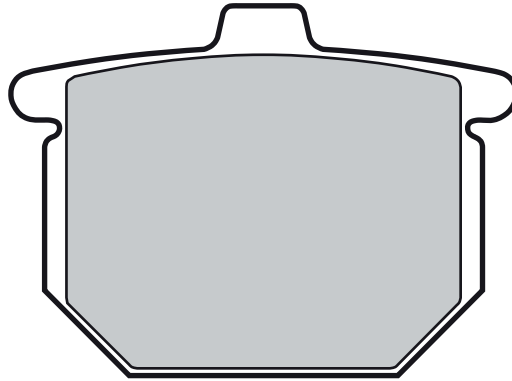

**HONDA**

125 MT R	78 >	•
400 CB	78 > 82	•
400 CB NA, NB	78 >	•
400 CB NZ	79 >	•

400 CX	81 >	•
400 GL	77 > 80	•
500 CX	78 > 80	•
750 CB F	77 > 80	• •
750 CB F2, SS	77 > 79	• •
900 CB F	78 > 80	• •

1000 CBX	78 > 80	• •
1000 GL GOLDWING, GRANTOUR	81 >	• •
1000 GL K3	78 > 79	•
1100 GL	79 > 80	• •



**07H004.11** 57.7 x 65.3 x 10.5

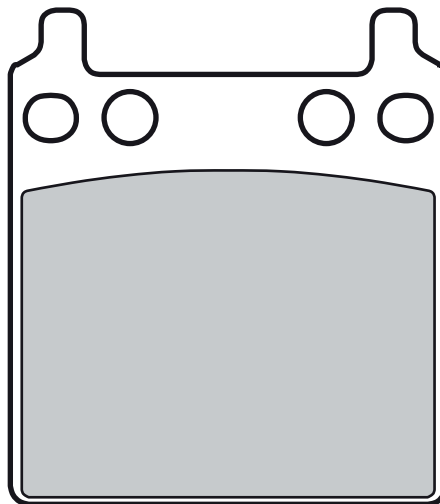

**HONDA**

750 CB F1	75 > 77	•
1000 GL K1, K2	75 > 77	•
1000 GL K3	78 > 79	•



**07H006.31** 39.3 x 39.3 x 21  
39.3 x 39.3 x 11

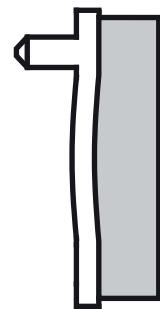
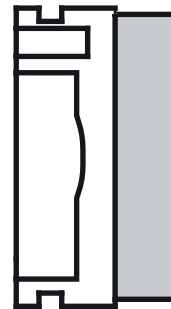
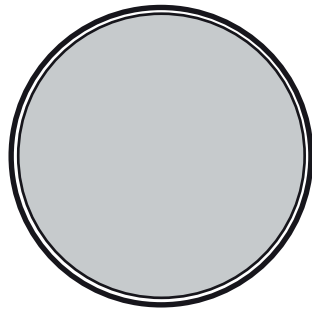

**HONDA**

50	CB K1, J	75 >	•
50	SS ZB2	75 >	•

90	9CB	79 >	•
110	CB	77 >	•
125	125 4 T	75 >	•

125	CB	77 >	•
125	CB J	79 >	•
125	MT R	77 > 77	•



**07H007.12** 52.5 x 52.9 x 11

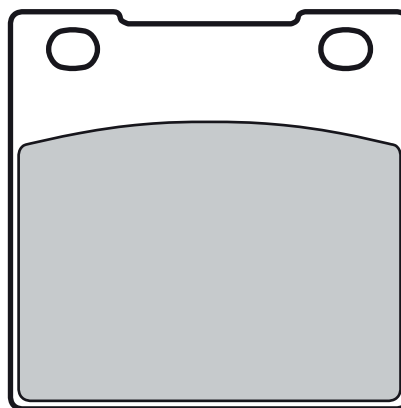

**HONDA**

250	CB N	78 >	•
250	CB ND	83 >	•
250	CB PSA, RSA, RDS	80 >	•
250	CB RS	80 > 85	•
250	CB RSC, RZC	82 >	•
250	CB T, TZ, NA, NB	77 >	•

250	CM TB	81 >	•
400	CB A, T1, T2	77 > 81	•
400	CB N, T, HAWH	78 >	•
400	CM A, T, TZ	79 >	•
400	CM T	79 > 84	•
400	CM T, CUSTOM	81 >	•
650	CB	80 > 84	•

650	CB Z	78 > 81	•
750	CB C, PZ, K, L	80 > 81	•
750	CB CUSTOM	81 >	•

**KAWASAKI**

250	CB RS	80 > 84	•
400	CM T	79 > 81	•



**07H008.31**

39.3 x 39.3 x 21

39.3 x 39.3 x 11

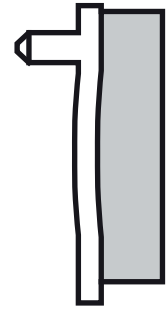
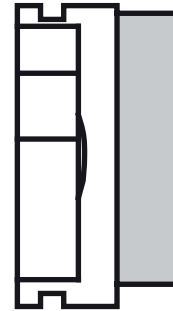
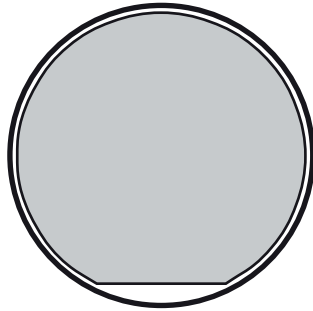

**HONDA**

100 CB N	79 >	•
125 CB T	85 >	•
125 CB T, T1, T2, TZ	77 >	•
250 FL ODISSEY	84 >	•



**07H009.06** 41.1 x 45 x 8

**07H009.SD** “ “ “

**07H009.SX** “ “ “

**07H009.TT** “ “ “

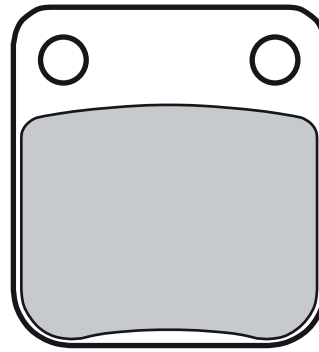

### DAELIM

125 S2	05 >	•
250 S2	06 >	•

### HONDA

50 CB (ALL MODELS)	80 > 81	•
50 CRM	89 > 92	•
50 MB	82 >	•
50 MBX	80 >	•
50 MRX	88 >	•
80 CB	80 > 81	•
80 CR R	86 > 91	•
80 CR R	92 > 97	•
80 MBX FWD	83 >	•
125 CB RS	83 >	•
125 CG	04 >	•
150 CG	04 >	•
250 ATC R	81 >	•

### HUSQVARNA

125 CR	92 > 94	•
125 WR	92 > 94	•
250 CR	92 > 94	•
250 WR	92 > 94	•
350 TE	92 > 94	•

### HYOSUNG

400 TE	05 >	•
450 TE	07 >	•

### KAWASAKI

125 BN ELIMINATOR A1, A2	98 > 99	•
125 KLX	10 >	•
125 KLX D-TRACKER	10 >	•
300 KVF BRUTE FORCE	13 >	•
400 KFX	02 >	•
400 KVF A1, A2, B1 PRAIRIE	97 > 98	•
400 KVF C1, C2 PRAIRIE 4X4	99 >	•
400 KVF D1, D2 PRAIRIE 2X4	99 >	•

### PEUGEOT

125 SUM-UP	11 >	•
------------	------	---

### SUZUKI

125 123 DR SF	85 >	•
125 DR	91 > 02	•
125 GX R	88 >	•
125 RH X	87 >	•
125 SP	85 > 88	•
125 TS X	85 >	•
200 DR	90 >	•
200 DR S	15 >	•
200 SP GHJ	88 >	•
240 RH X	87 >	•
240 TS X	85 >	•
250 DR S, F	85 > 89	•
250 LT-Z QUAD SPORT	04 >	•
250 OZARK	03 >	•
250 RH	85 >	•
250 SP F	85 >	•

250 TS X	85 >	•
400 LT-A EIGER 2WD/4WD	02 >	•
400 LT-F EIGER 2WD/4WD	02 >	•
400 LT-Z QUAD SPORT	02 >	•
500 LT-A VINSON	02 >	•

### YAMAHA

125 SX R	88 >	•
200 YFS R BLASTER	03 >	•
250 YFM AN BRUIN 2X4	05 >	•
250 YFM BEAR TRACKER	01 >	•
300 YFM WARRIOR	89 >	•
350 YFM BRUIN 2X4, 4X4	04 >	•
350 YFM FWB L, LC BIG BEAR (4WU/EBE)	99 >	•
350 YFM FXG-FXM WOLVERINE (4KB/EBE)	95 > 96	•
350 YFM XG,XH WARRIOR (3GD/EBE)	95 > 96	•
350 YFM XW, XA-M WARRIOR	89 >	• •
350 YFZ A-M BANSHEE	90 > 06	•
400 YFM FAM KODIAK	00 >	•
400 YFM FWN BIG BEAR 4WD	00 >	•
400 YFM FWNH BIG BEAR-BUCKMASTER 4WD	00 >	•
400 YFM N BIG BEAR 2WD	00 >	•
450 YFM FA_ KODIAK	03 >	•
450 YFM KODIAK	03 >	•
450 YFM WOLVERINE	06 >	•



**07H010.10** 89.9 x 49 x 11

**07H010.SA** “ “ “

**07H010.SP** “ “ “

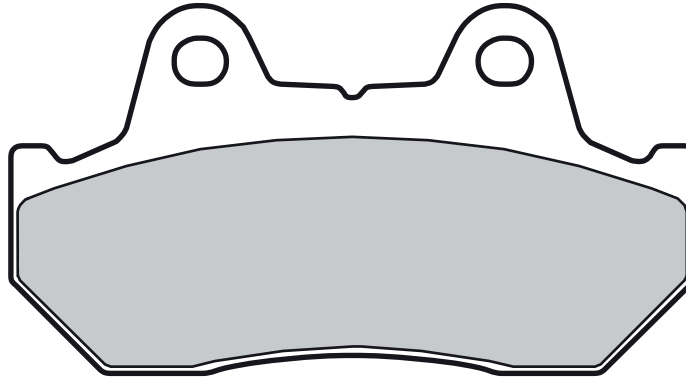

### HONDA

125	CB TDC	83 >	•
250	GB CLUBMAN	88 >	•
250	NS R	85 >	•
250	NSR R	87 >	•
400	CB	81 >	• •
400	CB FOUR	81 >	•
400	CB HAWK	81 >	• •
400	CB N	82 > 85	•
400	CB TWIN	82 >	•
400	CBR F, F2	85 >	• •
400	CBR R	87 >	•
400	CM C	81 >	•
400	CM T	85 >	•
400	GB TT	88 >	•
400	NSR	85 > 86	•
400	XELVIS	92 >	• •
450	CB T	82 >	•
450	CBR SR	91 >	• •
450	CM A, C	82 >	•
450	CMX REBEL	86 >	•
500	CB EC	83 >	•
500	CX	81 >	•
500	CX C	81 >	• •
500	CX E	85 >	• •
500	CX EURO	82 >	•
500	CX SILVER WING TURBO	81 > 83	• •
500	CX TURBO	81 > 83	•
500	FT	82 > 83	• •
500	GB TT	88 >	•
500	GL	81 > 82	•

500	GL D	81 >	•
500	NS R	85 >	• •
500	VF 2	83 >	• •
500	VT C	83 > 86	•
500	XBR S	85 >	•
550	CB SC	83 >	•
550	CBX	82 >	• •
600	CBR F	87 > 90	•
600	CBX E	85 >	•
600	XL LM	85 > 87	•
600	XL V TRANSALP	87 > 90	•
650	CB	85 >	•
650	CB SC	83 >	•
650	CBX ED, SC, SCD	83 >	•
650	CX C, T, TD, TURBO	83 >	• •
650	CX E	83 >	•
650	GL D	83 >	•
700	CB SC	84 >	•
700	VF F INTERCEPTOR	84 > 85	•
700	VF S	84 >	•
700	VFC MAGNA	84 >	•
700	VFC MAGNA	87 >	•
700	VFR F, F2	86 > 87	•
700	VT C, SHADOW	87 >	•
750	CB F, F2, K	85 >	•
750	CB F, K	81 > 82	• •
750	CB SC, KZ, C	82 > 83	•
750	CBR HURRICANE	87 >	•
750	CBX F	84 >	• •
750	NV CG, SHADOW	86 >	•
750	VFC	88 > 93	•

750	VF CUSTOM, SPORT	82 > 83	•
750	VF F	83 >	• •
750	VF S	85 >	•
750	VFR FJ, F	86 > 87	•
750	VP CH, CUSTOM	87 >	•
750	VT C, SHADOW	86 > 96	•
750	XLV R	83 > 85	•
800	VT C	88 >	•
900	CB C	82 >	• •
900	CB F, F2 BOL D'OR	81 > 84	• •
1000	CB C	83 >	• •
1000	CBR F	87 > 88	•
1000	CBX	81 > 82	•
1000	VF F	84 >	• •
1000	VF F2 BOL D'OR, F, F2	85 >	• •
1000	VF R	84 > 86	•
1000	VF R	86 > 88	• •
1000	VT C	88 >	•
1100	CB F	83 > 85	• •
1100	CB R,RB,RC	81 >	• •
1100	CB RD	83 >	• •
1100	GL	81 > 83	• •
1100	VF C, S	83 >	•
1100	VT SHADOW	87 > 93	•
1200	GL A, I	84 >	• •
1200	GL DX	86 >	• •
1200	GL GOLDWING	84 >	• •
1500	GL ASPENCADE	94 > 97	•
1500	GL GOLDWING SE	88 >	•
1500	GL GOLDWING SE	94 > 97	•
1500	GLX	88 > 96	•



**07H011.18** 84.9 x 42.4 x 7.8  
47.4 x 37 x 10

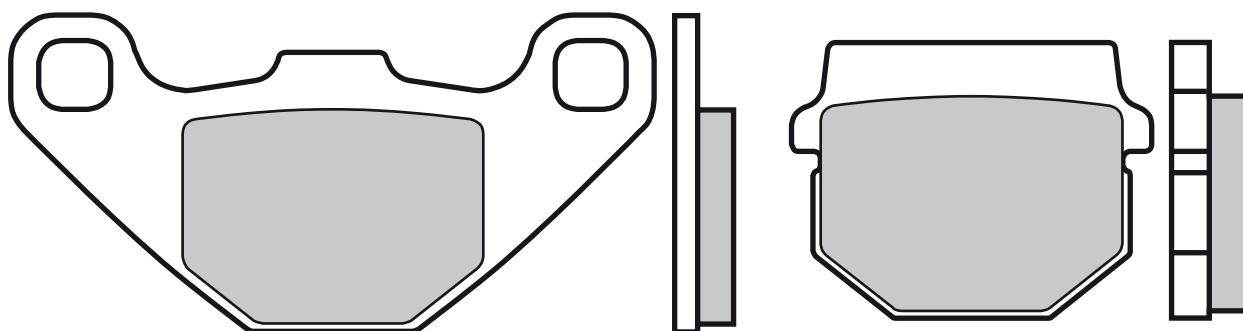

### HM

50	CRE	98 > 05	•
50	CRE BAJA	97 >	• •

### HONDA

80	MB	80 >	•
80	MCX	82 >	•

### KAWASAKI

80	KMX	87 >	•
125	KMX	87 > 90	•

### SUZUKI

80	RM G	86 > 89	•
80	RM L, M, N	90 > 95	•



**07H012.12** 66.9 x 49.1 x 12

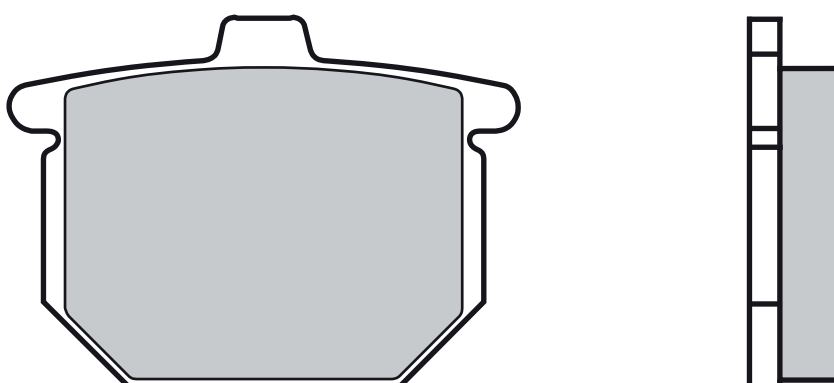

### HONDA

750	CB F2, SS	77 > 79	•
1000	GL K1, K2	75 > 77	•



**07H013.CC** 99.3 x 37.8 x 9.2

**07H013.SP** “ “ “

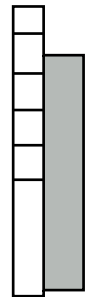
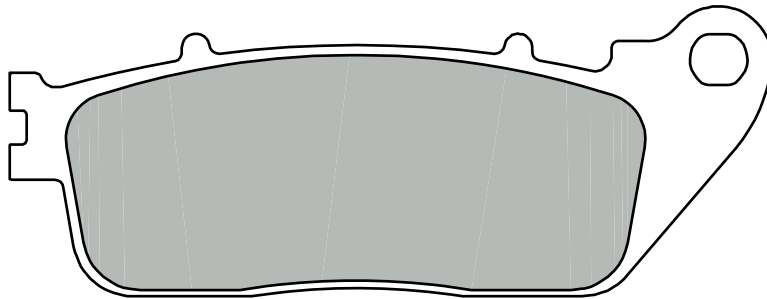
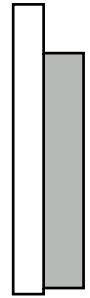
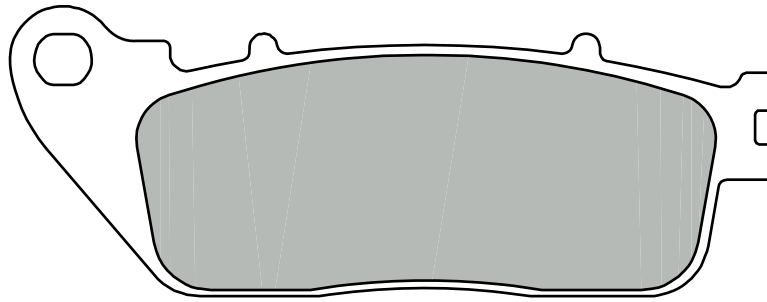

### HONDA

800	CROSSRUNNER	11 >	•
800	CROSSRUNNER	15 >	•
800	VFR F	14 >	•
1000	CB R	08 >	•
1000	CB R ABS	08 > 08	•
1000	CB R ABS	09 > 14	•



**07H014.06** 91.7 x 53.2 x 8

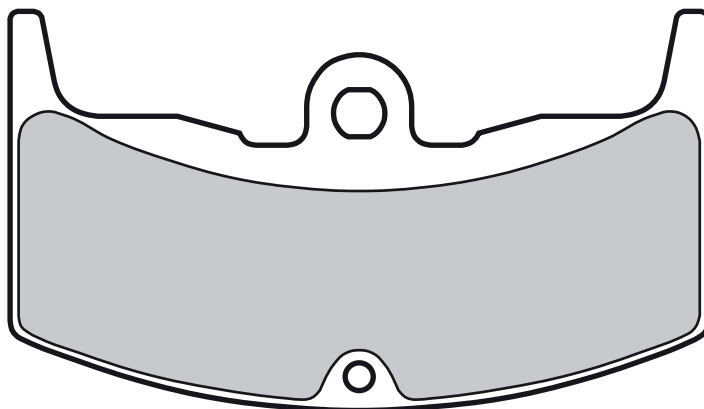

**HONDA**

250 VT E, FD

83 > •

250 VT F

83 > 87 •

250 VTR

88 > 89 •

400 CBX F, F2, F2C

82 > •

400 VF F

85 > •

400 VF FD

83 > •

400 VT E

83 > •

400 VT FD

83 > •

500 VT E

83 > •

500 VT ED

82 > • •

550 CBX F, F2, FC, F2C

82 > •

650 CBX E

83 > • •

900 CB FC, F2C

82 > •



**07H015.05** 80.9 x 41.7 x 7.3

**07H015.SD** “ “ “

**07H015.SX** “ “ “

**07H015.TT** “ “ “

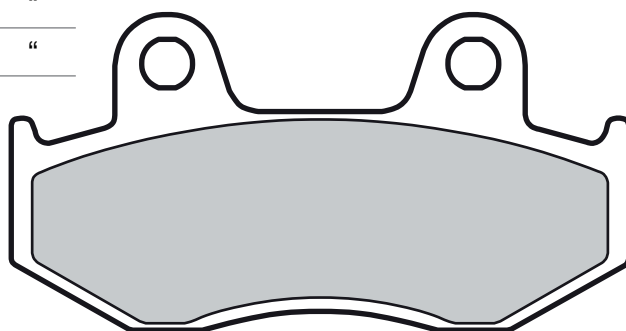

**HONDA**

80 MBX

86 > •

80 MTX R

87 > •

125 CR R

84 > 86 •

125 MTX

90 > •

125 MTX R

84 > 85 •

125 XL R

86 > •

200 ATC R

85 > • •

200 MTX R

86 > •

250 ATC R

85 > 86 • •

250 ATC X

85 > •

250 CB RS

86 > •

250 CR R

84 > 86 •

250 FTR

86 > • •

250 TRX R

86 > 89 •

250 TRX X FOURTRAX

87 > •

250 XL R

84 > 87 •

250 XLR R

88 > •

250 XR RE

84 > 87 •

350 ATC X

85 > 85 •

350 XL R

84 > 86 •

350 XL R ND 03

84 > •

350 XR R

84 > 85 •

500 CR R

84 > 86 •

500 XL R

83 > 84 •

500 XR R

83 > 86 •

600 XL R

83 > •

600 XL R, RD, LD

83 > •

600 XLM LM

87 > •

600 XR R

83 > 87 •





**07H016.09** 89.9 x 51.1 x 9.9

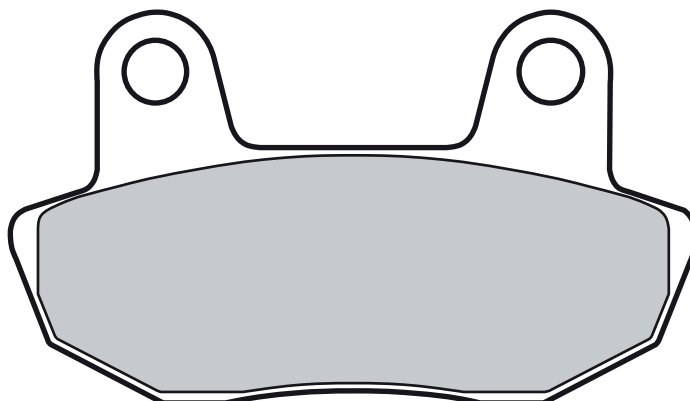

**HONDA**

450 CB N 84 > 85 •

450 CB SC NIGHTHAWK 82 > •

650 CB SCC NIGHTHAWK 82 > •

82 > •

700 VT C, SHADOW 84 > 86 •

750 VT C 83 > 85 •

84 > 86 •

83 > 85 •



**07H017.08** 91.7 x 53.2 x 9.5

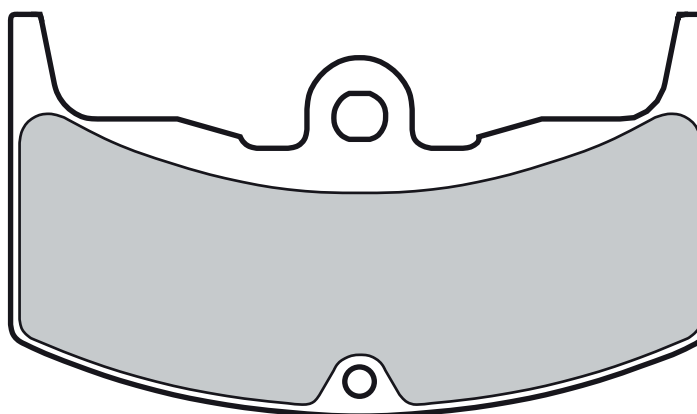

**HONDA**

400 CBX CUSTOM 88 > •

400 CBX F 85 > • •

400 CBX F, F2, F2C 82 > •

400 NV CUSTOM 88 > •

400 VF F 85 > •

400 VF FD 83 > •

82 > •

88 > •

85 > •

83 > •

400 VT E 83 > •

400 VT FD 83 > •

550 CBX F, F2, FC, F2C 82 > •

900 CB FC, F2C 82 > •

83 > •

83 > •

82 > •

82 > •



**07H018.07** 89.9 x 49 x 9

**07H018.SP** “ “ “

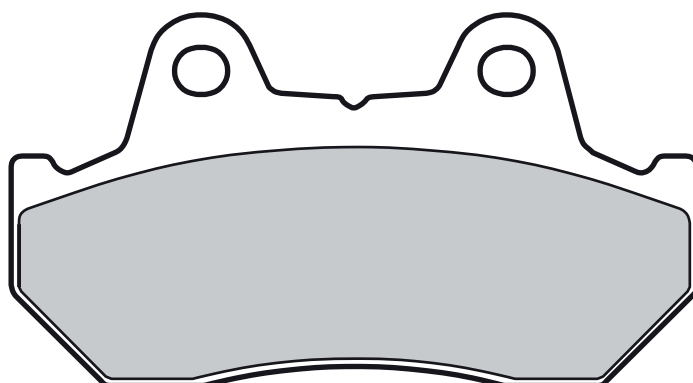

**HONDA**

125 CB T, SUPERDREAM	82 > •	400 NSR	85 > 86 •	500 VF 2	83 > •
125 CBX F	88 > •	400 VF INTEGRA	86 > • •	650 CX E	83 > •
250 CBX RSE	84 > •	450 CB SC NIGHTHAWK	83 > 86 •	700 VF F INTERCEPTOR	84 > 85 •
250 CBX S	88 > •	500 CB EC	83 > • •	700 VFC MAGNA	85 > 86 •
250 NS R	85 > •	500 CX EURO	82 > •	750 XLV R	86 > •
		500 CX TURBO	81 > 83 •	1000 CBX	81 > 82 •
		500 GL	81 > 82 •	1100 VF C, S	83 > •

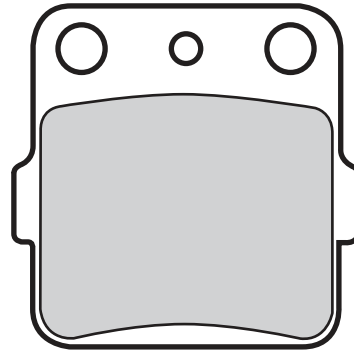

<b>07H020.SD</b>	45.9 x 45 x 6.5/7.5
<b>07H020.SX</b>	“ “ “
<b>07H020.TT</b>	“ “ “

**HM**

150 CRF R	07 > 09	•
-----------	---------	---

**HONDA**

200 ATC X	83 > 85	•
-----------	---------	---

200 ATC XD	83 >	•
------------	------	---

250 ATC R	82 > 84	•
-----------	---------	---

250 ATC X	85 >	•
-----------	------	---

350 ATC X	85 > 85	•
-----------	---------	---

350 ATC X	86 >	•
-----------	------	---

83 >	•
------	---

82 > 84	•
---------	---

85 >	•
------	---

85 > 85	•
---------	---

86 >	•
------	---

**SUZUKI**

230 LT SG	86 >	•
-----------	------	---

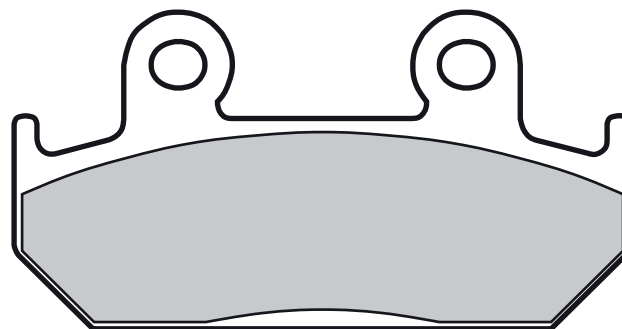

<b>07H021.07</b>	81.1 x 42.1 x 8.9
<b>07H021.SA</b>	“ “ “
<b>07H021.SC</b>	“ “ “

**HONDA**

250 CBR F	86 >	•
-----------	------	---

250 CBR HURRICANE	87 >	•
-------------------	------	---

250 NSR R	87 >	•
-----------	------	---

250 VT F	88 >	•
----------	------	---

250 VTR	90 > 97	•
---------	---------	---

250 VTZ	88 >	•
---------	------	---

350 CB S G	87 >	•
------------	------	---

350 NX	92 >	•
--------	------	---

400 CB N	86 >	•
----------	------	---

400 CBR F	92 >	•
-----------	------	---

400 CBR R	87 >	•
-----------	------	---

400 VFR R	86 > 87	• •
-----------	---------	-----

400 VFR R	88 > 88	• •
-----------	---------	-----

400 VFR Z	88 >	•
-----------	------	---

450 CB S	86 >	•
----------	------	---

600 CBR F	87 > 90	•
-----------	---------	---

600 CBR F, SUPER SPORT	91 > 94	•
------------------------	---------	---

600 NTV REVERE	88 >	•
----------------	------	---

600 VT SHADOW CUSTOM	89 > 91	•
----------------------	---------	---

750 XRV AFRICA TWIN	90 > 92	•
---------------------	---------	---



**07H022.05** 45.9 x 45 x 6.5

**07H022.SD** “ “ “

**07H022.SX** “ “ “

**07H022.TT** “ “ “

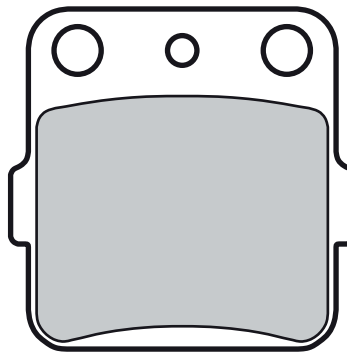

### HONDA

75	CRM	92 >	•
80	CR	03 >	•
80	CR R, RB	96 > 02	•
80	CRM	89 >	•
200	ATC XD	83 >	•
250	ATC R	82 > 84	•

### SUZUKI

125	RM H	87 > 88	•
230	LT EH, S	86 > 93	•
230	LT SF-SJ	85 > 88	•
250	LT RF-RH	85 > 87	•
250	RM H	87 > 88	•

### YAMAHA

125	YZ	89 > 89	•
250	YZ	89 > 89	•
300	YFM WARRIOR	89 >	•
350	YFM XT	87 > 88	•
360	YZ	89 >	•



**07H023.07** 88.2 x 46.1 x 8.4

**07H023.SA** “ “ “

**07H023.SP** “ “ “

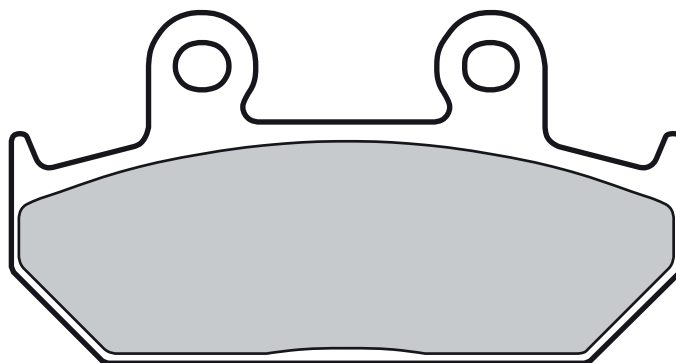

### HONDA

125	RS (GP)	88 > 90	•
250	CB	88 > 91	•
250	CD	88 >	•

400	STEED	88 > 91	•
600	NV C	88 >	•
600	NX DOMINATOR	93 >	•
600	STEED	88 > 91	•
650	NX DOMINATOR	93 > 96	•

700	VFR F, F2	86 > 87	•
750	CBR HURRICANE	87 >	•
750	VFR FJ, F	86 > 87	•
1000	CBR F	87 > 88	•



**07H024.08** 54.9 x 52.4 x 9.4

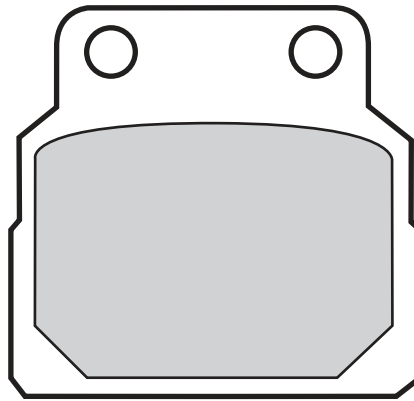

**HONDA**

450 CB DX	89 >	• •
450 CB N	86 >	•



**07H025.06** 94 x 31.9 x 7.4

**07H025.SD** “ “ “

**07H025.SX** “ “ “

**07H025.TT** “ “ “

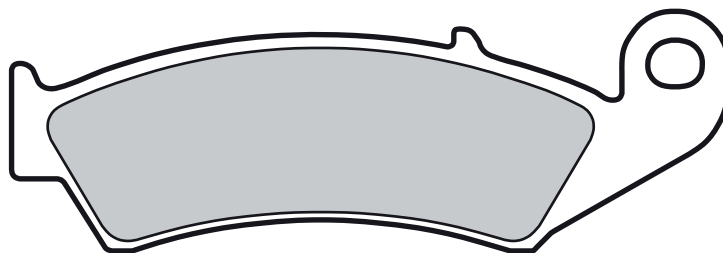

**HONDA**

125 CR R, RK	87 > 94	•	250 NX	88 > 90	•	350 ATC X	86 >	•
250 AX-1	88 > 89	•	250 TRX R	86 > 89	•	500 CR	87 > 94	•
250 AX-1	90 >	•	250 TRX X FOURTRAX	87 >	•	600 XR R	88 > 90	•
250 CR R	87 > 94	•	250 XL DEGREE	91 >	•	600 XR R	91 > 92	•
250 CRM	90 >	•	250 XLR BAJA	88 > 90	•	600 XR R DAKAR	89 > 90	•
			250 XR R	88 > 89	•	600 XR R DAKAR	91 > 92	•
			250 XR R, L	90 > 93	•			



**07H026.08** 74.9 x 36.1 x 9.5

**07H026.SD** “ “ “

**07H026.SX** “ “ “

**07H026.TT** “ “ “

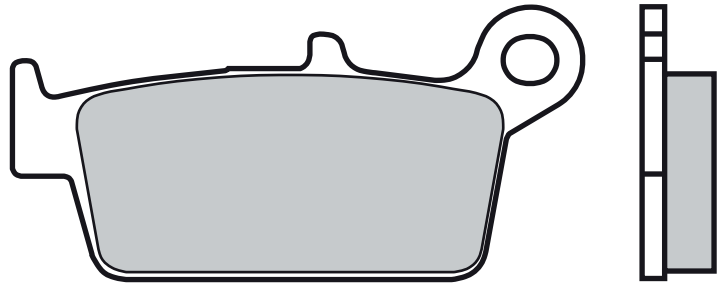

### BIMOTA

508 BBX ENDURO 12 > •

### FANTIC MOTOR

50 MX REGOLARITÀ  
COMPETIZIONE 08 > •

65 MX REGOLARITÀ  
COMPETIZIONE 08 > •

85 MX REGOLARITÀ  
COMPETIZIONE 08 > •

### GAS GAS

125 EC 00 > •

125 MC 03 > •

125 SM 02 > •

200 EC 00 > •

200 HOBBY 07 > •

250 EC 00 > 11 •

250 MC 00 > •

250 SM 02 > •

300 EC 00 > 11 •

400 EC 02 > •

400 FSE SM 02 > •

400 PAMPERA 06 > •

450 EC 03 > •

450 FSE EC 03 > •

450 FSE SM 03 > 06 •

450 FSR 07 > •

450 SM FSR 07 > •

500 FSE EC 06 > •

515 FSR 08 > •

### HM

50 CRE 06 > •

125 CRE ENDURO 95 > 01 •

125 CRE SUPERMOTARD 03 > •

125 SUPERMOTARD 00 > •

250 CRE ENDURO 95 > 01 •

250 CRE SUPERMOTARD 03 > 03 •

250 CRE SUPERMOTARD 04 > •

250 SUPERMOTARD 00 > •

### HONDA

50 CB REPLICIA 99 > •

80 MB 80 > •

80 MCX 82 > •

80 MCX S 82 > •

80 MTX R 87 > •

125 CA REBEL 95 > 96 •

125 CR R, RK 87 > 94 •

125 CR RK 95 > 01 •

230 CRF 04 > •

230 SL 97 > •

250 AX-1 88 > 89 •

250 CR R 87 > 94 •

250 CR R 95 > 01 •

250 XLR BAJA 88 > 90 •

250 XLR R, SPL 94 > •

250 XR R, L 90 > 93 •

250 XR R, L, S 94 > •

300 XR 10 > •

400 XR 96 > •

400 XR SUPERMOTARD 00 > •

440 XR R 00 > •

500 CR 87 > 94 •

500 CR 95 > 01 •

600 XR R 91 > 92 •

600 XR R 93 > •

600 XR R DAKAR 91 > 92 •

600 XR R DAKAR 93 > •

650 BROS 88 > •

650 NTV HAWK 89 > 91 •

650 XR L 93 > •

650 XR R 00 > •

### HYOSUNG

400 XRV 05 > •

### KAWASAKI

125 KX 95 > •

250 KLX 98 > •

250 KLX 250 09 > •

250 KLX S, SF 09 > •

250 KX 95 > •

300 KLX 97 > •

400 KLX R/SR 03 > •

500 KX 96 > •

650 KLX R 96 > 98 •

### SHERCO

450 ENDURO 04 > 04 •

### SUZUKI

125 RM T 96 > 05 •

250 DR Z 01 > •

250 RM T 96 > 05 •

250 RMX 99 > •

400 DRZ E 00 > 04 •

400 DRZ S 00 > 04 •

### TM

85 85 01 > 12 •

125 125 01 > 04 •

125 ENDURO 01 > 04 •

125 SMR 05 > •

125 SMX 06 > •

250 250 01 > 04 •

250 250 4-STROKE 01 > •

250 E 01 > •

250 E 4-STROKE 01 > 04 •

300 300 01 > •

300 E 01 > 04 •

400 4T 01 > •

400 E 4 STROKE 01 > •

400 SMR F 02 > 02 •

400 SMR F 03 > •

450 4T 02 > 04 •

450 ENDURO 4 STROKE 02 > 04 •

450 SMR F 04 > •

450 SMX F 03 > •

530 4T 01 > 04 •

530 E 4 STROKE 01 > 04 •

530 SMR F 03 > •

530 SMR F ES 03 > •

600 SMX F 03 > •

660 SMX F 05 > •

### YAMAHA

125 WR 98 > 08 •

125 YZ 98 > 02 •

250 WR 98 > 02 •

250 WR F 01 > 02 •

250 YZ 98 > 02 •

250 YZ F 01 > 02 •

400 WR F 99 > 00 •

400 YZ F 99 > 02 •

426 WR F 01 > 02 •

426 YZ F 00 > 02 •



**07H027.11** 86.1 x 39.9 x 10.7

**07H027.SP** “ “ “

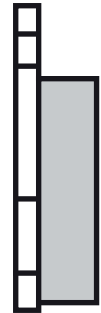
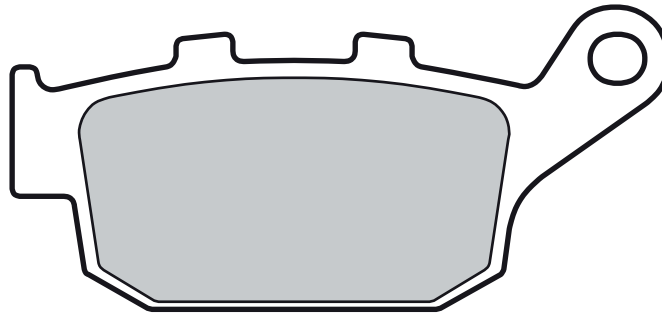

### BUELL

500	BLAST	01 >	•
984	XB9R FIREBOLT	02 >	•
984	XB9S LIGHTNING	03 >	•
984	XB9SX CITY X	05 >	•
1200	M2	98 > 02	•
1200	M2 CYCLONE	98 > 02	•
1200	RS X1	98 >	•
1200	S1 LIGHTNING	98 > 02	•
1200	S1 WHITELIGHTNING	98 > 02	•
1200	S3 THUNDERBOLT	98 > 02	•
1200	S3T THUNDERBOLT	98 > 02	•
1200	X1	01 > 02	•
1200	XB12 R	04 >	•
1200	XB12 R FIREBOLT	09 >	•
1200	XB12 S LIGHTNING	04 > 08	•
1200	XB12 S LIGHTNING	09 >	•
1200	XB12 SCG LIGHTNING	04 > 08	•
1200	XB12 SCG LIGHTNING	09 >	•
1200	XB12 STT SUPER TT	07 >	•
1200	XB12 X ULYSSES	06 >	•

### HONDA

250	CBR HURRICANE	87 >	•
250	CBR R, RR	90 >	•
250	CBR RJ	88 >	•
250	NSR RJ, R, SP	88 >	•
250	RS R	91 > 92	•
250	VT SPADA	89 >	•
250	VTR	98 >	•
400	BROS 2	88 >	•
400	CB FK	90 >	•
400	CB SUPER FOUR	92 > 95	•

400	CB-1	89 > 90	•
400	CBR RR	88 > 94	•
400	VFR Z	88 >	•
400	VRX T ROADSTER	95 >	•
600	NTV BROS 1	88 >	•
600	NTV REVERE	88 >	•
600	NX DOMINATOR	93 >	•
600	XL V TRANSALP	91 > 93	•
600	XL V TRANSALP	94 > 96	•
600	XL V TRANSALP	97 > 99	•
600	XL V TRANSALP VR/VT	94 > 96	•
650	FMX	05 >	•
650	NTV	94 >	•
650	NTV DEAUVILLE	98 > 00	•
650	NTV REVERE	88 > 93	•
650	NTX BROS	90 >	•
650	NX DOMINATOR	88 > 92	•
650	NX DOMINATOR	93 > 96	•
650	XL V TRANSALP	00 >	•
650	XRV AFRICA TWIN	88 >	•
700	VF FR INTERCEPTOR	88 > 89	•
700	X	12 >	•
700	XL TRANSALP	08 >	•
750	CB NIGHTHAWK	91 >	•
750	XRV AFRICA TWIN	90 > 92	•
750	XRV AFRICA TWIN	93 >	•

### PEUGEOT

250	SATELIS RS	11 >	•
-----	------------	------	---

### SUZUKI

650	XF FREEWIND	97 >	•
-----	-------------	------	---

### TRIUMPH

600	DAYTONA	04 >	•
600	SPEED FOUR	03 >	•
600	TT	00 > 03	•
650	DAYTONA	05 >	•
675	DAYTONA	06 > 08	•
675	DAYTONA R TRIPLE	11 > 12	•
675	DAYTONA TRIPLE	09 >	•
675	STREET TRIPLE	08 >	•
675	STREET TRIPLE R	09 >	•
800	TIGER	11 >	•
800	TIGER XC	11 >	•
800	TIGER XC ABS	12 >	•
800	TIGER XCA	15 >	•
800	TIGER XCR	15 >	•
800	TIGER XR	15 >	•
800	TIGER XRT	15 >	•
800	TIGER XRx	15 >	•
1215	TIGER EXPLORER XC	16 >	•
1215	TIGER EXPLORER XCa	16 >	•
1215	TIGER EXPLORER XCx	16 >	•
1215	TIGER EXPLORER XR	16 >	•
1215	TIGER EXPLORER XRt	16 >	•
1215	TIGER EXPLORER XRx	16 >	•

### YAMAHA

600	FZ 6R	09 >	•
600	XJ 6	09 >	•
600	XJ S F DIVERSION	10 > 11	•
600	XJ S FA DIVERSION ABS	11 > 11	•



**07H028.07** 67.8 x 53.7 x 8.1

**07H028.SA** “ “ “

**07H028.SC** “ “ “

**07H028.RC** “ “ “

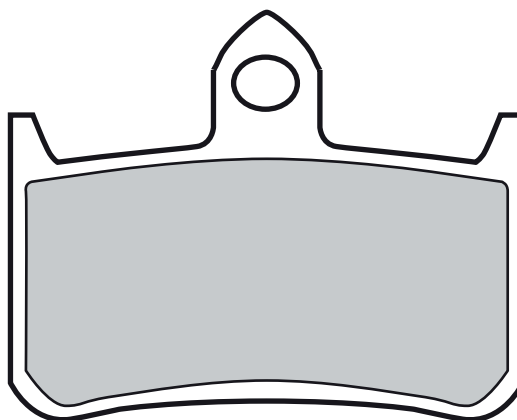

**HONDA**

125 NS	89 >	•
250 NS	89 >	•
250 NSR RJ, R, SP	88 >	•
250 RS R	91 > 92	•
400 BROS 2	88 >	•

400 RVF RR	90 >	•
400 VFR R	89 > 92	•
400 VTR R	90 >	•
600 NTV BROS 1	88 >	•
650 BROS	88 >	•
650 NTX BROS	90 >	•
750 NR	92 >	•

90 >	•
89 > 92	•
90 >	•
88 >	•
88 >	•
90 >	•
92 >	•

750 RVF (RC 45)	94 >	•
750 VFR R (RC 30)	88 > 93	•
900 CBR RR	92 > 97	•
900 HORNET	02 >	•
1000 CB BIG ONE	93 > 95	•
1000 VTR F	97 >	•
1300 CB X-4	97 >	•

94 >	•
88 > 93	•
92 > 97	•
02 >	•
93 > 95	•
97 >	•
97 >	•



**07H029.11** 94 x 31.9 x 8.4

**07H029.SP** “ “ “

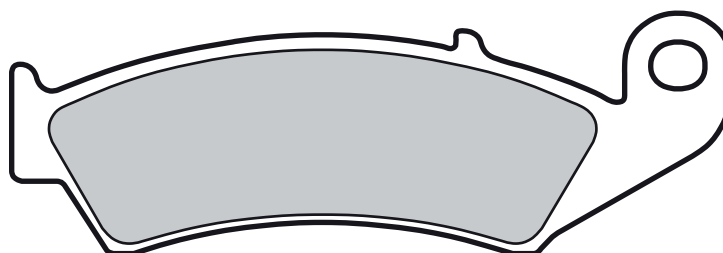

**HONDA**

400 RVF RR	90 >	•
400 VFR R	89 > 92	•
400 VTR R	90 >	•
750 RVF (RC 45)	94 >	•
750 VFR R (RC 30)	88 > 93	•





**07H030.05** 102.1 x 38.9 x 8.1

**07H030.SA** “ “ “

**07H030.SC** “ “ “

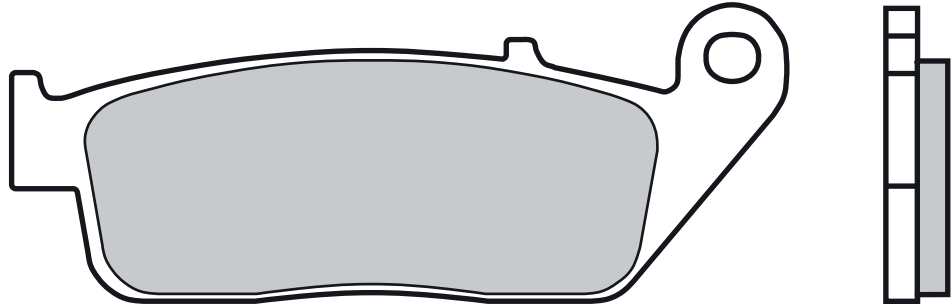

### BUELL

500 BLAST 01 > •

### CAGIVA

900 GRAN CANYON 99 > •

1000 NAVIGATOR 00 > •

### HONDA

125 RS (GP) 91 > 94 •

125 XLR R 98 > •

125 XR L 03 > •

250 CB 92 > •

250 CBR NIGHTHAWK 92 > •

250 CBR R 11 > •

250 CBR R, RR 90 > •

250 CBR RJ 88 > •

250 STEED 93 > •

250 VT SPADA 89 > •

400 CB FK 90 > •

400 CB-1 89 > 90 •

400 CBR RR 88 > 94 •

400 STEED 92 > •

400 VRX T ROADSTER 95 > •

500 CB 94 > 96 •

600 CBF N 03 > 11 •

600 CBF S 04 > 09 •

600 CBR F 11 > •

600 CBR F SPORT 11 > 12 •

600 CBR F3 95 > 98 •

600 HORNET 98 > 06 •

600 HORNET 07 > •

600 HORNET / S 00 > 06 •

600 STEED 92 > •

600 VT C, SHADOW 93 > •

600 VT CD SHADOW VLX 94 > •

650 FMX 05 > •

650 NTV 94 > •

650 NTV HAWK 89 > 91 •

650 NTV REVERE 88 > 93 •

700 VF FR INTERCEPTOR 88 > 89 •

700 X 12 > •

750 CB N, SEVEN FIFTY 92 > •

750 CB NIGHTHAWK 91 > •

750 VFR F 88 > 89 •

750 VFR F 90 > 97 •

800 PC 89 > 97 •

950 VFR F 92 > •

1000 CBR F, FJ, FK 89 > 92 •

1000 VF R 89 > •

1100 ST PAN EUROPEAN 90 > 02 •

1100 VT C2 Y 00 > •

1100 VT SHADOW 94 > 96 •

1100 VT SHADOW C2 95 > 98 •

1100 VT SHADOW C3 99 > •

1300 FURY 10 > •

1300 VT FURY 10 > •

1300 VTX 03 > •

1300 VTX C 04 > •

1500 GL C VALKIRIA 96 > •

1500 GLX 97 > •

### HYOSUNG

250 AQUILA 00 > •

### KAWASAKI

650 VERSYS 15 > 15 •

650 VERSYS 16 > •

650 VERSYS ABS 16 > •

650 VERSYS LT 15 > •

750 Z 750 07 > •

750 Z 750 ABS 07 > •

800 Z 800 ABS 13 > •

### SUZUKI

250 GSF IMPULSE 95 > •

250 INAZUMA 12 > •

400 GSX IMPULSE 94 > •

400 RF 93 > •

600 GSF BANDIT 95 > 99 •

600 RF R 93 > 96 •

1500 C INTRUDER 13 > •

### SWM

440 GRAN MILANO 15 > •

440 GRAN TURISMO 15 > •

440 SILVER VASE 15 > •

### TRIUMPH

675 STREET TRIPLE 08 > •

800 AMERICA 03 > 06 •

800 BONNEVILLE 01 > 04 •

800 BONNEVILLE AMERICA 02 > •

800 BONNEVILLE BLACK 04 > •

800 BONNEVILLE T100 PAUL SMITH 06 > 08 •

800 SPEEDMASTER 03 > 04 •

800 TIGER 11 > •

800 TIGER XC 11 > •

800 TIGER XCA 15 > •

800 TIGER XCR 15 > •

800 TIGER XR 15 > •

800 TIGER XRT 15 > •

800 TIGER XRx 15 > •

865 BONNEVILLE SE 09 > •

865 BONNEVILLE T100 09 > •

865 NEW BONNEVILLE 09 > •

885 THUNDERBIRD SPORT 04 > •

900 ADVENTURER 96 > •

900 AMERICA 07 > •

900 BONNEVILLE 05 > 08 •

900 BONNEVILLE 09 > •

900 BONNEVILLE 15 > •

900 BONNEVILLE NEWCHURCH 15 > •

900 BONNEVILLE SPIRIT 15 > •

900 BONNEVILLE T100 05 > 08 •

900 BONNEVILLE T100 09 > •

900 BONNEVILLE T100 16 > •

900 BONNEVILLE T214 15 > •

900 LEGEND TT 99 > •

900 SCRAMBLER 06 > •

900 STREET TWIN 16 > •

900 THRUXTON 04 > •

900 THRUXTON ACE 15 > •



900 THUNDERBIRD	96 > 02	•
900 THUNDERBIRD	03 >	•
900 TIGER	99 > 00	•
900 TIGER	01 > 04	• •
955 TIGER	01 > 03	• •
955 TIGER	04 > 06	•
1200 BONNEVILLE T120		
1200 BLACK	16 >	•
1200 THRUXTON	16 >	•

### VOXAN

1000 SCRAMBLER	01 >	•
----------------	------	---

### YAMAHA

125 WR R, XY	09 >	•
250 WR X	08 >	•



**07H031.09** 102.1 x 38.9 x 9.6

**07H031.SP** “ “ “

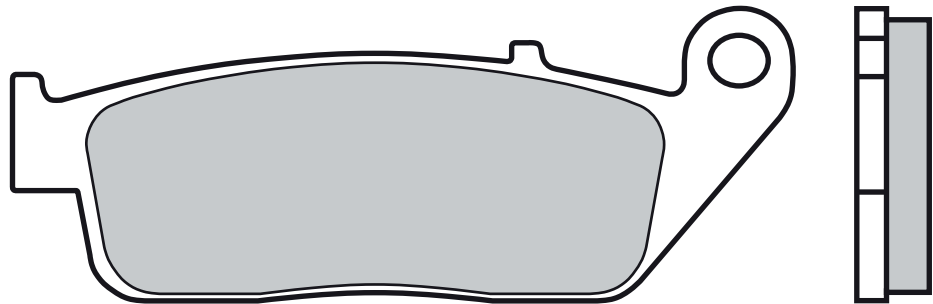

### DAELIM

125 DAYSTAR	00 >	•
125 ROADWIN	04 >	•
125 ROCKET	99 >	•
125 S2	05 >	•
125 VL DAYSTAR	00 >	•
125 VT EVOLUTION	00 >	•
125 VT MAGNA	99 >	•
150 ROADWIN X5	06 >	•
250 ROADWIN	08 >	•
250 S2	06 >	•

### HONDA

680 DN-01	08 >	•
750 VFR F	88 > 89	•
750 VFR F	90 > 97	•
950 VFR F	92 >	•
1000 CBR F, FJ, FK	89 > 92	•
1000 VF R	89 >	•
1500 GL C VALKIRIA	96 >	•
1500 GLX	97 >	•

### INDIAN

1800 CHIEF CLASSIC	14 >	•
1800 CHIEF VINTAGE	14 >	•
1800 CHIEFTAIN	14 >	•
1800 SCOUT	15 >	•

### TRIUMPH

885 THUNDERBIRD SPORT	04 >	•
900 ADVENTURER	96 >	•
900 LEGEND TT	99 >	•
900 THUNDERBIRD	96 > 02	•
900 THUNDERBIRD	03 >	•
900 TIGER	99 > 00	•

### VICTORY

1634 HAMMER	08 >	•
1634 KINGPIN ALL MODELS	08 >	•
1634 VEGAS	08 >	•
1634 VEGAS 8-BALL	08 >	•
1634 VEGAS JACKPOT	08 >	•

1731 BOARDWALK	13 >	•
1731 CROSS COUNTRY	10 >	•
CROSS COUNTRY	14 >	•
8-BALL	14 >	•
1731 CROSS COUNTRY TOUR	12 >	•
1731 CROSS ROADS	10 >	•
1731 CROSS ROADS 8-BALL	14 >	•
1731 CROSS ROADS CLASSI	14 >	•
1731 HAMMER	09 >	•
1731 HAMMER 8-BALL	10 >	•
1731 HAMMER S	09 >	•
1731 HARD-BALL	12 >	•
1731 HIGH-BALL	12 >	•
1731 JACKPOT	10 >	•
1731 JUDGE	13 >	•
1731 KINGPIN	10 >	•
1731 KINGPIN 8-BALL	10 >	•
1731 VEGAS	10 >	•
1731 VEGAS 8-BALL	10 >	•
1731 VEGAS JACKPOT	09 >	•



<b>07H032.SP</b>	45.9 x 45 x 7.5
<b>07H032.SD</b>	“ “ “
<b>07H032.SX</b>	“ “ “

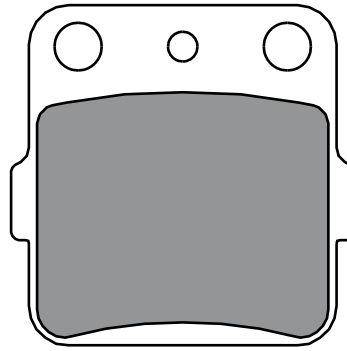

### ARCTIC CAT

400 DVX	04 >	•
---------	------	---

### HONDA

85 CR R, R EXPERT	03 >	•
150 CRF R	07 >	•
200 ATC X	83 > 85	•
250 TRX EX SPORTRAX	01 > 08	•
250 TRX X	08 >	•
250 X 250	08 >	•
300 TRX EX SPORTRAX	01 > 08	• •
300 TRX X	09 >	• •
400 TRX EX SPORTRAX	01 > 08	• •
400 TRX FOURTRAX EX	99 >	• •
400 TRX X	09 >	• •
420 TRX FA / FPA	09 >	•
420 TRX FPE / FPM 4X4	09 >	•
450 TRX EX SPORTRAX	01 >	• •

### KAWASAKI

65 KX	00 >	•
-------	------	---

80 KX L, N, R	88 > 96	•
80 KX R7, T7, W1, W2, Y1, Y2	97 > 00	•
85 KX, II	01 >	•
100 KX	88 > 96	•
100 KX	97 >	•
250 KSF A1-A17 MOJAVE	87 >	•
250 KXF A1, A2 TECATE	87 > 88	•
250 KXT B2 TECATE	87 >	•
300 KEF LAKOTA	95 >	•
450 KFX RIGHT CALIPER	07 >	•

### SUZUKI

65 RM	03 >	•
100 RM	03 >	•
230 LT EH-EP	86 > 93	•
250 LT SK, SL	89 > 90	•
500 RM H	87 >	•
800 DR Z	88 > 90	•

### TM

80 JUNIOR	96 > 00	•
-----------	---------	---

### YAMAHA

80 YZ E, F, G, H1, J1	93 > 01	•
85 YZ	02 >	•
200 YFS R BLASTER	03 >	•
250 YFM RAPTOR left/rear	09 >	•
YFM FXG-FXM		
350 WOLVERINE (4KB/EBE)	95 > 96	•
350 YFM R RAPTOR	04 >	• •
YFM XG, XH WARRIOR		
350 (3GD/EBE)	95 > 96	•
350 YFM XT, XU WARRIOR	87 > 88	•
350 YFZ A-M BANSHEE	90 > 06	•
350 YFZ T-W BANSHEE	87 > 89	•
450 YZF S	04 > 05	•
YFM FWAK-FWAN 4X4		
600 GRIZZLY	98 > 01	•
660 YFM GRIZZLY FWAP 4X4	02 >	•
660 YFM RN RAPTOR	01 >	• •



<b>07H033.CC</b>	39.9 x 56.2 x 9.5
------------------	-------------------

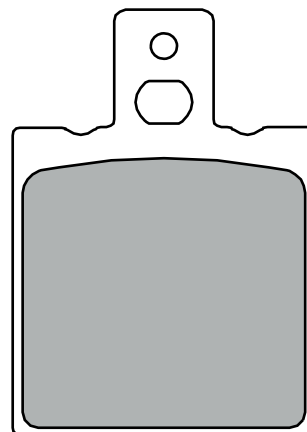

### HONDA

125 CRM	90 > 98	•
125 NSR F	90 > 92	•
125 NSR R, ITALY	89 >	•



**07H034.05** 102.1 x 38.9 x 10.4

**07H034.SP** “ “ “

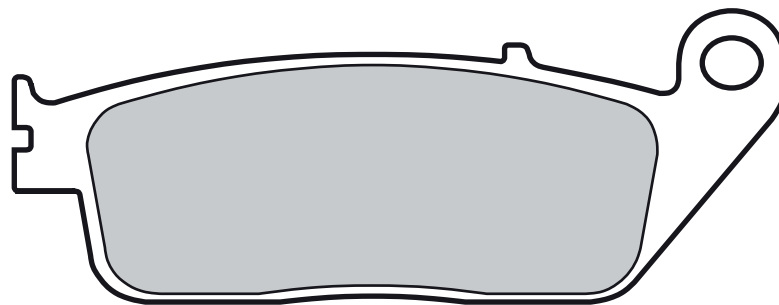

### HONDA

250 VTR	98 >	•
400 CB SUPER FOUR	92 > 95	•
750 VF C	94 >	•
1100 ST ABS-TCS-CBS	92 > 95	•
1100 ST PAN EUROPEAN	90 > 02	•

### KYMCO

250 VENOX	01 >	•
-----------	------	---

### YAMAHA

1700 MT-01	05 >	•
1700 MT-01	07 >	•



**07H035.09** 88.2 x 46.1 x 10.5

**07H035.SA** “ “ “

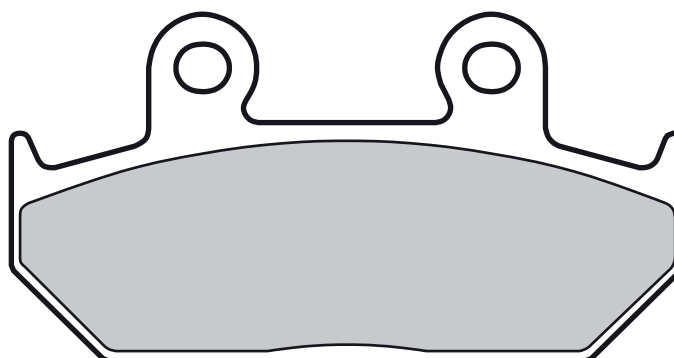

### CAGIVA

500 CANYON	99 >	•
900 CANYON I.E.	97 > 98	•
900 ELEFANT I.E.	90 >	•

### HONDA

125 CB TT	90 >	•
600 VT C, SHADOW	92 > 92	•
600 VT SHADOW CUSTOM	88 >	•
600 XL V TRANSALP	91 > 93	•

650 NX DOMINATOR	88 > 92	•
650 XRV AFRICA TWIN	88 >	•
1500 GL ASPENCADE	94 > 97	•
1500 GL GOLDWING SE	88 >	•
1500 GL GOLDWING SE	94 > 97	•
1500 GLX	88 > 96	•



**07H036.07** 85.7 x 40 x 8.9  
**07H036.SP** “ “ “

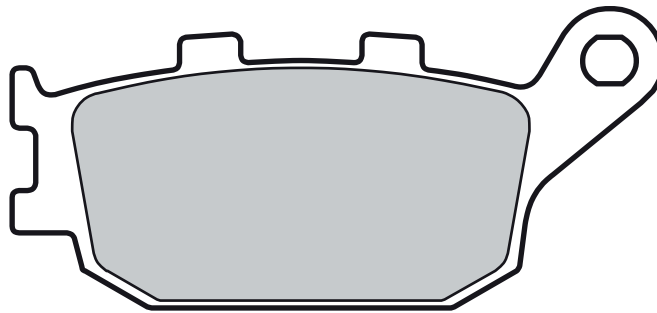

### HONDA

400	CBR F	92 >	•
500	CBF	04 >	•
500	CBF ABS	04 >	•
600	CBF	08 >	•
600	CBF N	03 > 11	•
600	CBF N ABS	08 > 11	•
600	CBF S	04 > 09	•
600	CBF S ABS	08 > 12	•
600	CBR F, SUPER SPORT	91 > 94	•
600	CBR F3	95 > 98	•
600	CBR F4	99 > 02	•
600	CBR RR	03 > 04	•
600	CBR RR	05 > 06	•
600	HORNET	98 > 06	•
600	HORNET / S	00 > 06	•
600	HORNET ABS	07 >	•
650	NTV DEAUVILLE	01 > 02	•
700	NC S	12 >	•
700	NC SA ABS	12 >	•
700	NC SD ABS	12 >	•
700	NC X	12 >	•
700	TRX INTEGRA	12 >	•
700	XA ABS	12 >	•
700	XAD ABS	12 >	•
700	XL TRANSALP ABS	09 >	•
750	CB N, SEVEN FIFTY	92 >	•
750	INTEGRA DCT/DCTS	14 >	•
750	NR	92 >	•
900	CBR RR	92 > 97	•
900	CBR RR	98 > 99	•
900	CBR RR FIREBALDE	02 > 03	•
900	CBR RR FIREBLADE	00 > 01	•
900	HORNET	02 >	•
929	CBR RR	00 > 01	•
954	CBR RR	02 > 03	•
1000	CB BIG ONE	93 > 95	•
1000	CBF	06 >	•
1000	CBF	09 >	•
1000	CBF F ABS	15 >	•

1000	CBF ST ABS	09 >	•
1000	CBF1000ST ABS	09 >	•
1000	CBR RR	04 > 05	•
1000	CRF L AFRICA TWIN	15 >	•
1000	VTR F	97 >	•
1000	VTR SP01	00 >	•
1000	VTR SP02	00 >	•
1100	CB	13 >	•
1100	VT C2 Y	00 >	•
1100	VT SHADOW	94 > 96	•
1100	VT SHADOW C2	95 > 98	•
1100	VT SHADOW C3	99 >	•
1300	CB	11 >	•
1300	CB S	11 >	•
1300	CTX	14 >	•
1300	FURY	10 >	•
1300	VT FURY	10 >	•
1300	VTX	03 >	•

### KAWASAKI

650	VULCAN S	15 >	•
750	Z 750	07 >	•
750	Z 750 ABS	07 >	•
750	Z R	11 >	•
1000	KLV right caliper	04 >	•
1000	VERSYS	12 >	•
1000	VERSYS LT	15 >	•
1000	Z	07 > 09	•

### SUZUKI

250	INAZUMA	12 >	•
650	DL V STROM	04 >	•
650	DL V STROM XT (left/rear)	15 >	•
650	GSF ABS	07 >	•
650	GSF S ABS	07 >	•
650	GSX F	08 >	•
650	SV	03 > 08	•
750	GSR	11 >	•
1000	DL V STROM	02 > 13	•

1000	SV	03 >	•
1000	SV S	03 >	•
1250	GSF ABS	07 >	•
1250	GSF S ABS	07 >	•
1250	GSX F	10 >	•
1250	GSX FA	10 >	•
1300	B-KING	07 >	•

### YAMAHA

600	FZ 6	04 >	•
600	FZ 6 FAZER	04 >	•
600	FZ6 FAZER S2	07 >	•
600	FZ6 FAZER S2 ABS	07 >	•
600	FZ6 S2	07 >	•
600	FZ6 S2 ABS	07 >	•
600	XJ 6 N	13 > 13	•
600	XJ 6 N SP	13 > 13	•
600	XJ 6 NA ABS	13 > 13	•
600	XJ 6 S DIVERSION	13 > 13	•
600	YZF R6	03 >	•
700	MT 07	14 >	•
700	MT 07 MOTOCAGE	15 >	•
700	XSR 700	16 >	•
700	XSR 700 SPEED BLOCK	16 >	•
800	FZ 8	10 >	•
800	FZS FAZER	10 >	•
850	MT 09	14 >	•
850	MT 09 ABS	14 >	•
850	MT 09 SPORT TRACKER	15 >	•
850	MT 09 STREET RALLY	14 >	•
850	MT 09 STREET RALLY ABS	14 >	•
850	MT 09 TRACER	15 >	•
900	XSR 900	16 >	•
900	XSR 900 SPEED BLOCK	16 >	•
1000	FZ1	06 >	•
1000	FZ1 FAZER	06 >	•
1000	YZF R1	04 > 06	•
1000	YZF R1	07 > 14	•
1000	YZF R1 SP	06 >	•



**07H037.SA** 68.9 x 51 x 9  
32.7 x 49.9 x 9

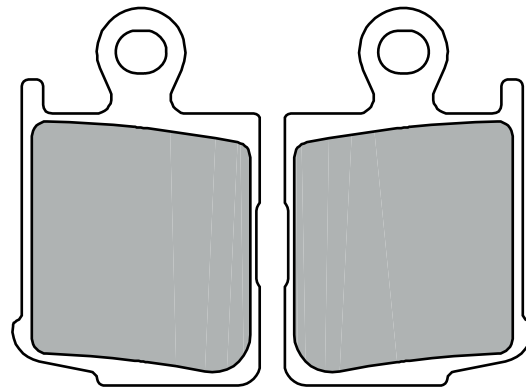
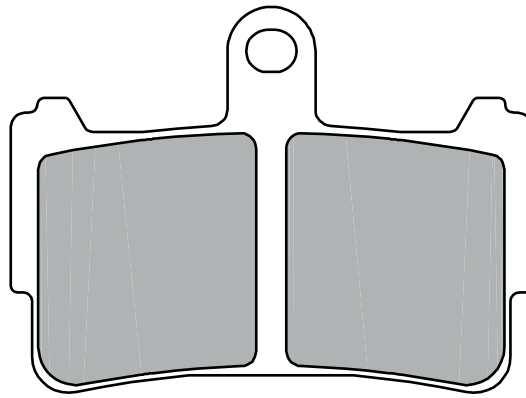

**HONDA**

1200 F W/DCT	10 >	•
1200 VFR F	10 >	•
1200 VFR FW	10 >	•



**07H039.07** 125.5 x 44.3 x 8.7  
**07H039.SA** “ “ “  
**07H039.SP** “ “ “

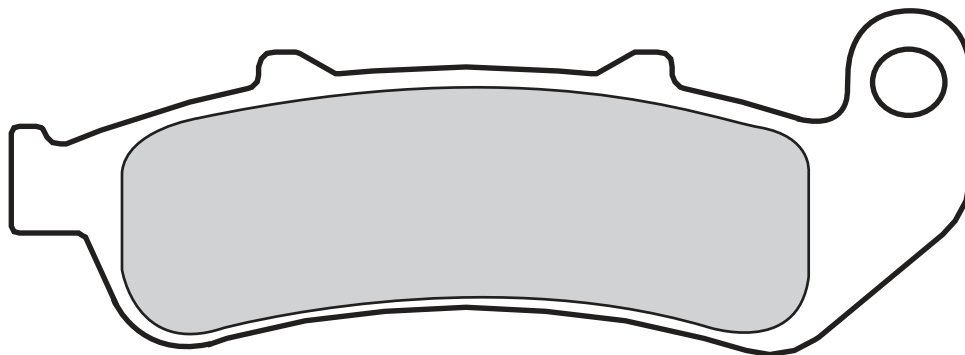

**HONDA**

1000 CBR F, FP	93 > 98	• •
1100 ST ABS-TCS-CBS	92 > 95	•

**07H040.08**

79.9 x 41.9 x 9.2

96.6 x 41.9 x 9.2

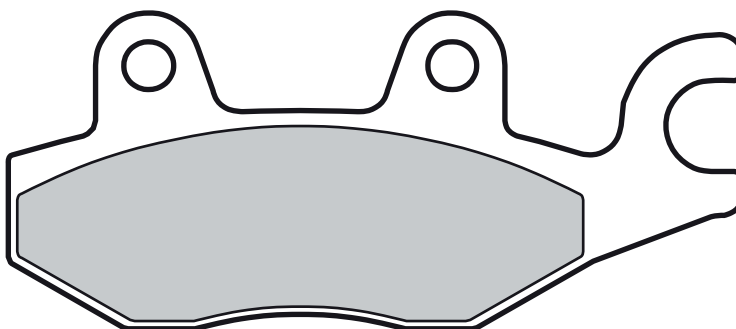
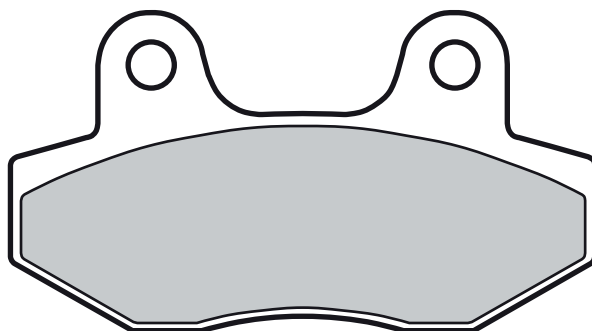
**HONDA**

125 VARADERO	01 >	•
125 VT SHADOW	99 >	•
150 NSR	02 >	•
250 CB F	04 >	•
300 CB	10 >	•

**ITALJET**

50 ROLLERCRAFT	08 >	•
125 TORPEDO	08 >	•
150 TORPEDO	08 >	•

**KYMC0**

125 K-PIPE	13 >	•
------------	------	---





**07H041.08** 102.1 x 38.9 x 9.6

**07H041.SA** “ “ “

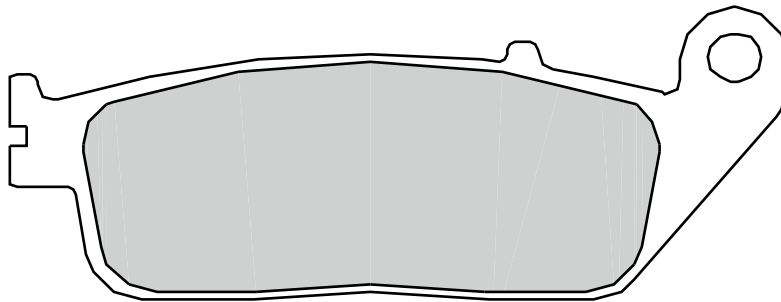
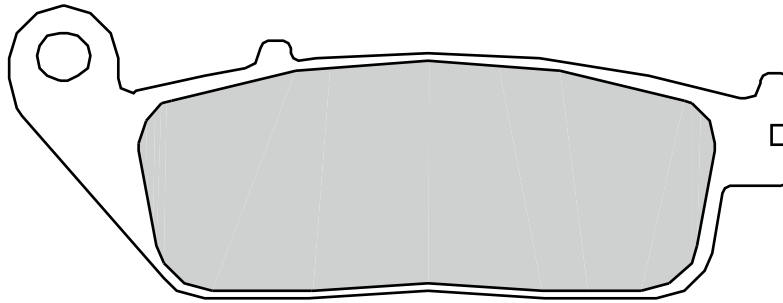

### HONDA

300	CBR F	14 >	•
300	CBR R	15 >	•
500	CB F	13 >	•
500	CB F ABS	13 > 14	•
500	CB X	13 >	•
500	CB X ABS	13 > 14	•
500	CBF	04 >	•
500	CBR R	04 >	•
500	CBR R ABS	13 > 14	•
500	F	13 >	•
500	R	13 >	•
500	X	13 >	•
600	XL V TRANSALP	94 > 96	•
600	XL V TRANSALP VR/VT	94 > 96	•

650	CB F	14 >	•
650	CBR F	14 >	•
700	CTX	14 >	•
700	CTX D ABS W/DCT	14 >	•
700	CTX N	14 >	•
700	CTX ND ABS W/DCT	14 >	•
700	NC X	12 >	•
700	VULTUS ABS w/DCT	15 >	•
750	BLACK WIDOW	01 >	•
750	INTEGRA	14 >	•
750	INTEGRA DCT/DCTS	14 >	•
750	NC S	14 >	•
750	NC S ABS	14 >	•
750	NC S DCT	14 >	•
750	NC X	14 >	•

750	NC X ABS	14 >	•
750	NC X ABS DCT	14 >	•
750	SHADOW	04 >	•
750	VT C 2B	11 >	•
750	VT C, SHADOW	97 > 03	•
750	VT RS, S	11 >	•
750	VT SHADOW SPIRIT	07 >	•
750	VULTUS ABS w/DCT	15 >	•
1000	CBF	06 >	•
1000	CBF	09 >	•

### TRIUMPH

900	ADVENTURER	95 > 95	•
900	THUNDERBIRD	95 > 95	•



**07H042.06** 115 x 40.1 x 8.3

**07H042.SA** " " "

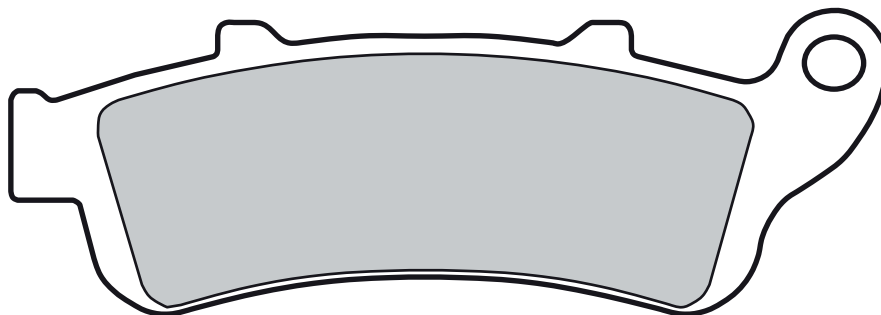

**HONDA**

650 NTV DEAUVILLE	03 >	•
800 VFR FI	98 > 01	•
800 VFR V-TEC ABS	02 > 05	•
1000 CBR XX	96 >	•
1000 VARADERO ABS	04 >	•
1000 XL VARADERO	99 > 03	•

1000 XL VARADERO (LINKED BRAKE SYSTEM)	00 >	•
1100 CB HORNET	99 >	•
1100 CB X 11	00 >	•
1100 CBR XX	96 >	•
1100 ST	96 >	•
1300 STX PAN EUROPEAN	02 >	•

1800 GL GOLDWING	01 >	•
1800 GL GOLDWING F6B	13 >	•
1800 VTX	01 >	•

**KAWASAKI**

650 VULCAN S	15 >	•
--------------	------	---



**07H043.08** 115 x 40.1 x 8.3

**07H043.SP** " " "

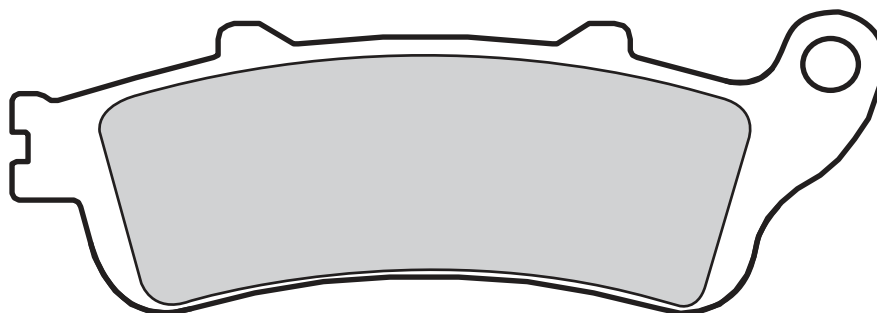

**HONDA**

650 NTV DEAUVILLE	03 >	•
700 NT DEAUVILLE ABS	06 >	•
700 NT VARADERO ABS	10 >	•
800 VFR FI	98 > 01	•
800 VFR V-TEC ABS	02 > 05	•
800 VFR V-TEC ABS	06 >	•

1000 CBR XX	96 >	•
1000 VARADERO ABS	04 >	•
1000 XL VARADERO	99 > 03	•
1000 XL VARADERO (LINKED BRAKE SYSTEM)	00 >	•
1000 XLV VARADERO ABS	04 >	•
1000 XLV VARADERO TRAVEL ABS	04 >	•

1100 CB HORNET	99 >	•
1100 CB X 11	00 >	•
1100 CBR XX	96 >	•
1100 ST	96 >	•
1300 FURY ABS	10 >	•
1300 STX PAN EUROPEAN	02 >	•
1300 VTX C	04 >	•
1800 VTX	01 >	•



**07H044.CC** 115 x 40.1 x 7.6

**07H044.SA** " " "

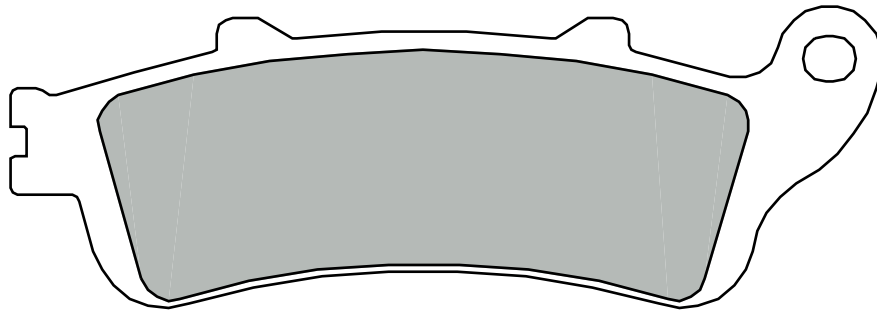
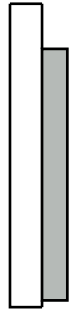
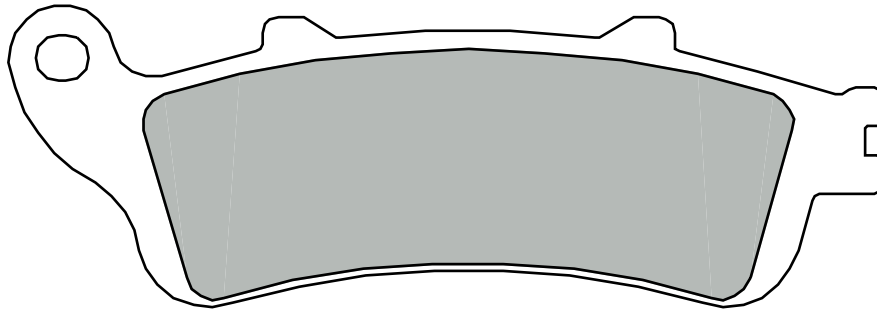

**HONDA**

1100 ST A6 ABS-TCS-CBS 96 > •



0821 000 555

0821 000 777



**DOM TOM**



+33 3 89 70 3000



+33 3 89 70 30 99



**07H045.07** 74.5 x 55.2 x 7.2

**07H045.SA** “ “ “

**07H045.SC** 74.5 x 55.2 x 8

**07H045.RC** “ “ “

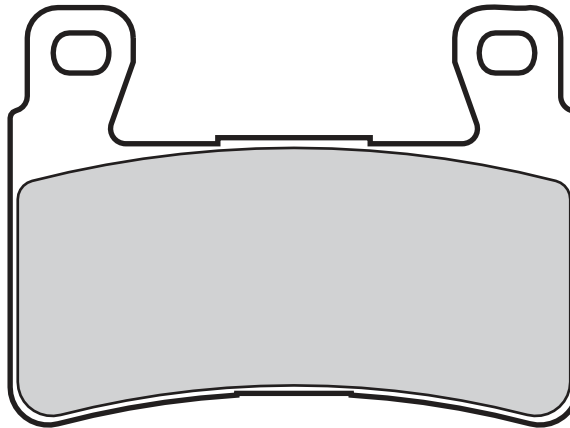

### HONDA

600	CBR F4	99 > 02	•
600	CBR RR	03 > 04	•
900	CBR RR	98 > 99	•
900	CBR RR FIREBALDE	02 > 03	•
900	CBR RR FIREBLADE	00 > 01	•
929	CBR RR	00 > 01	•

954	CBR RR	02 > 03	•
1000	VTR SP01	00 >	•
1000	VTR SP02	00 >	•
1300	CB R	02 >	•

### HYOSUNG

125	GD EXIV	12 >	•
-----	---------	------	---

250	GD EXIV-R	15 >	•
250	GT IR	15 >	•
650	GT I	13 >	•
650	GT IR	13 >	•
650	i NAKED	15 >	•
650	LR	15 >	•



**07H046.07** 75.1 x 42 x 8.1

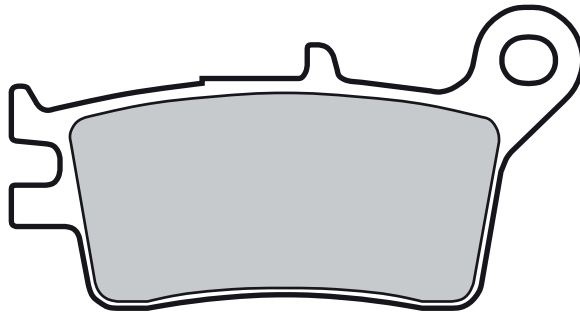
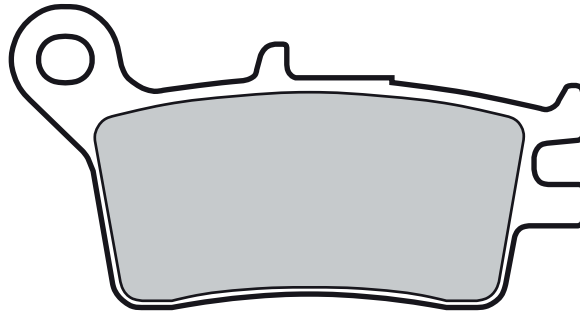

**HONDA**

220	TLM	89 >	•
260	TLM R	90 >	•



**07H047.CC** 74.9 x 55.5 x 7.6

**07H047.SA** “ “ “

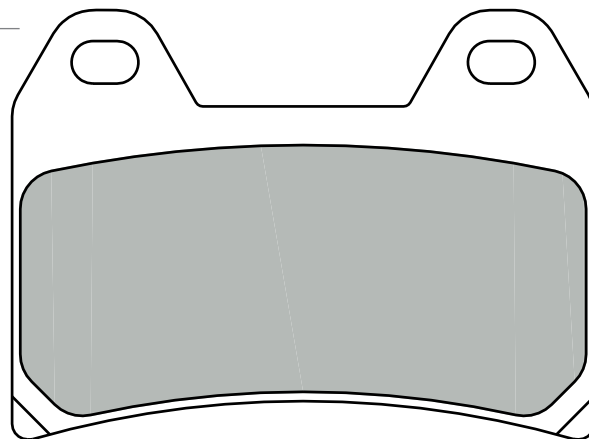

**HONDA**

400	CB SUPER FOUR S	97 >	•
-----	-----------------	------	---



**07H048.SD** 59.7 x 43.7 x 9.5

**07H048.SX** “ “ “

**07H048.TT** “ “ “

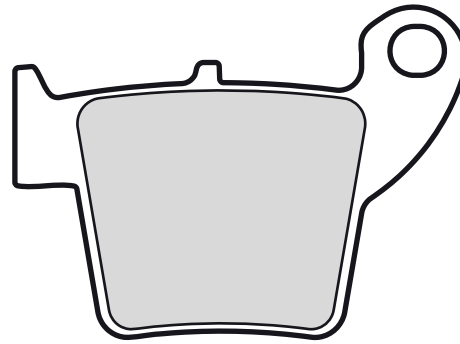
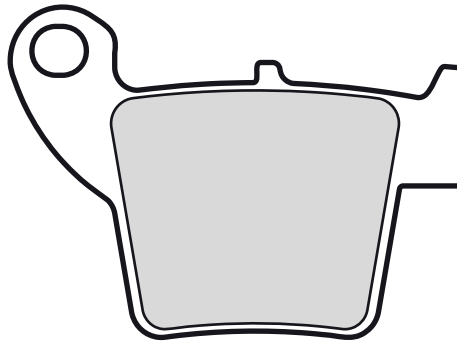

### FANTIC MOTOR

125	CABALLERO ENDURO	12 >	•
125	CABALLERO MOTARD	10 >	•
125	CABALLERO REGOLARITÀ	10 >	•
200	CABALLERO MOTARD	10 >	•
200	CABALLERO REGOLARITÀ	10 >	•

### HM

50	CRE BAJA RR	07 > 09	•
50	CRE SIX COMPETITION	07 > 08	•
50	CRE SIX COMPETITION	09 >	•
50	CRM DERAPAGE	09 >	•
125	CR SUPERMOTARD	04 >	•
125	CRE BAJA	11 >	•
125	CRE R ENDURO	02 > 03	•
125	CRE SIX COMPETITION	11 >	•
125	CRM DERAPAGE	11 >	•
125	CRM X SUPERMOTARD	07 > 07	•

150	CRF R	07 > 09	•
250	CRE F ENDURO	04 >	•
250	CRE FX	08 > 11	•
250	CRE R ENDURO	02 >	•
250	CRE X	04 >	•
250	CRE X ENDURO	04 > 09	•
250	CRF X SUPERMOTARD	04 >	•
250	CRM X SUPERMOTARD	07 >	•
450	CRE F ENDURO	02 >	•
450	CRE X ENDURO	04 >	•
450	CRF F SUPERMOTARD	04 >	•
450	CRF R	04 > 09	•
450	CRF SUPERMOTARD	02 >	•
450	CRF X SUPERMOTARD	04 >	•
450	CRM X SUPERMOTARD	07 >	•
490	CRE FX	07 >	•
490	CRM F SUPERMOTO	07 > 07	•
500	CRM F SUPERMOTO	11 >	•
500	CRM X SUPERMOTARD	07 > 09	•

### HONDA

125	CR E	02 >	•
125	CR R	02 >	•
150	CRF R	07 >	•
250	CR E	02 >	•
250	CR R	02 >	•
250	CRE F	04 >	•
250	CRE X	04 >	•
250	CRF R	04 >	•
250	CRF R	14 >	•
450	CRE F	02 >	•
450	CRF R	09 >	•
450	CRF X	05 >	•
450	CRF, E	02 >	•
450	CRF, EFI	13 >	•
450	TRX X	04 >	•

### TM

85	85	13 >	•
----	----	------	---



**07H049.05** 106.7 x 42.4 x 10  
91.4 x 39.8 x 10

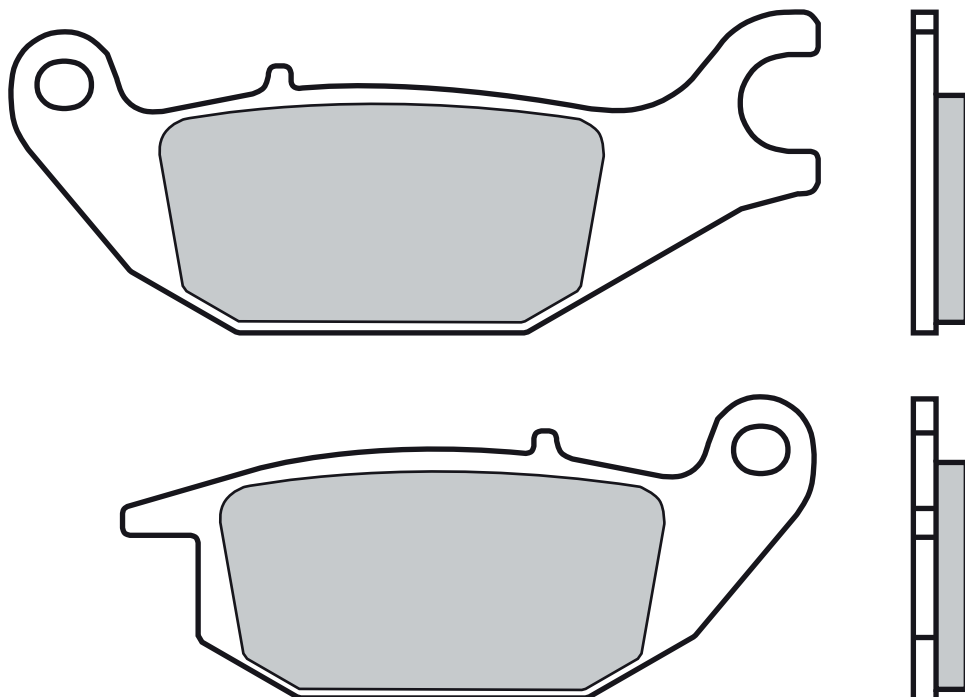

**HONDA**

125	CBR R	04 >	•
125	VARADERO	01 >	•
150	CBR R	00 >	•



**07H050.SA** 74.1 x 46.7 x 8  
**07H050.SC** 74.1 x 46.7 x 9  
**07H050.RC** “ “ “

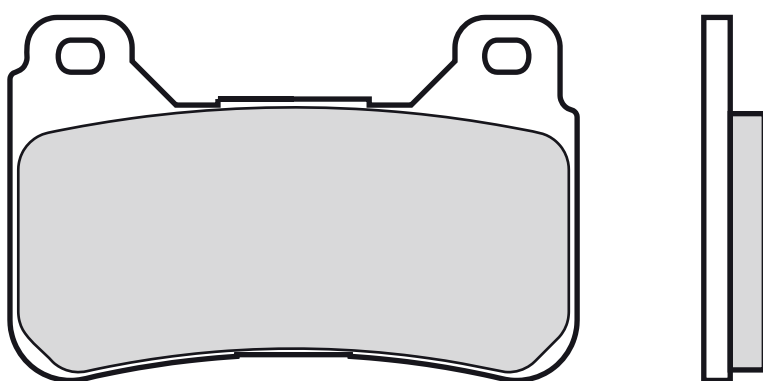

**HONDA**

600	CBR RR	05 > 06	•
600	CBR RR	07 >	•
600	CBR RR	09 >	•
600	CBR RR ABS	09 > 12	•

800	CROSSRUNNER	15 >	•
	ADVENTURE		
800	VFR F	14 >	•
1000	CB R	08 >	•
1000	CB R ABS	09 > 14	•

1000	CBR RR	04 > 05	•
1000	CBR RR	06 >	•
1000	CBR RR ABS	09 >	•
1000	CBR RR FIREBLADE	09 >	•
1000	CBR RR FIREBLADE ABS	09 >	•



**07H052.SP** 115 x 40.1 x 10.3

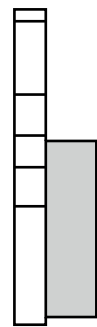
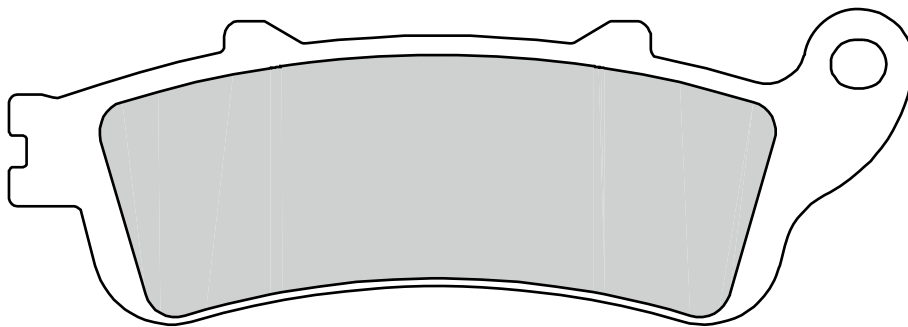
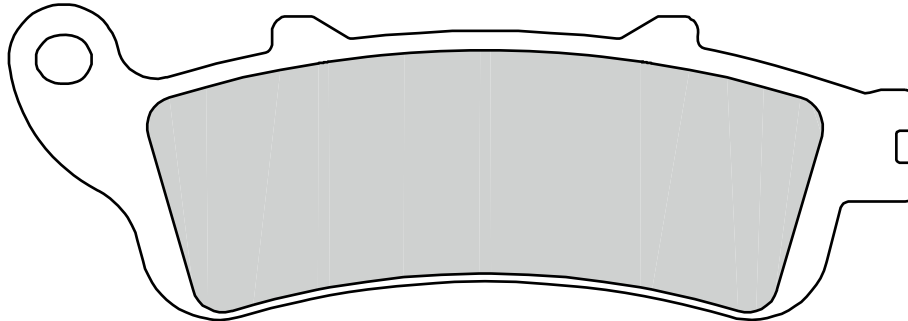

**HONDA**

1800 GL GOLDWING	01 >	•
1800 GL GOLDWING F6B	13 >	•



0821 000 555



0821 000 777



**DOM  
TOM**



+33 3 89 70 3000



+33 3 89 70 30 99





**07H053.CC**

86.1 x 39.9 x 9

**07H053.SP**

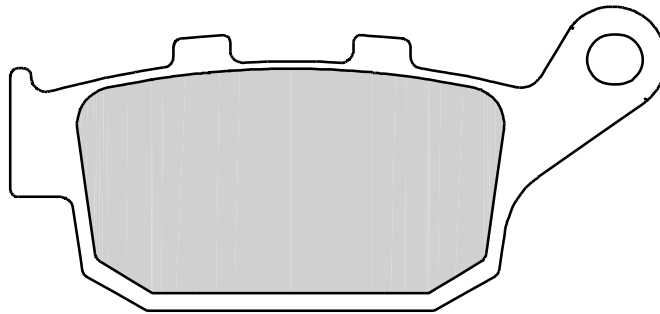
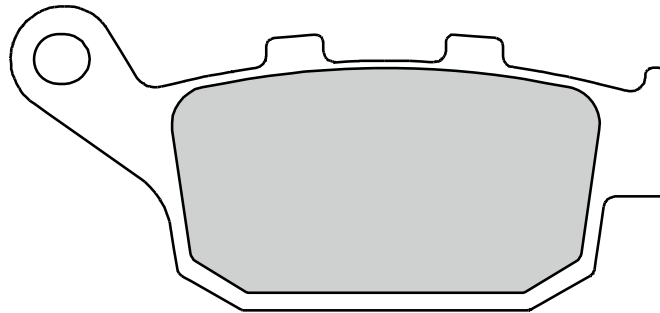
“ “ “

**HONDA**

250 CBR R	11 >	•
250 CBR R ABS	11 >	•
300 CBR F	14 >	•
300 CBR R	15 >	•
500 CB F	13 >	•
500 CB F ABS	13 > 14	•
500 CB X	13 >	•
500 CB X ABS	13 > 14	•
500 CBR R	04 >	•
500 CBR R ABS	13 > 14	•
650 CB F	14 >	•
650 CBR F	14 >	•
700 CTX	14 >	•
700 CTX D ABS W/DCT	14 >	•

700 CTX N	14 >	•
700 CTX ND ABS W/DCT	14 >	•
700 VULTUS ABS w/DCT	15 >	•
750 INTEGRA	14 >	•
750 NC S	14 >	•
750 NC S ABS	14 >	•
750 NC S DCT	14 >	•
750 NC X	14 >	•
750 NC X ABS	14 >	•
750 NC X ABS DCT	14 >	•
750 VULTUS ABS w/DCT	15 >	•

**KAWASAKI**

650 VERSYS	15 > 15	•
650 VERSYS	16 >	•

650 VERSYS ABS	16 >	•
650 VERSYS LT	15 >	•
750 Z 750 R	11 >	•
750 Z 750 R ABS	11 > 12	•
800 Z 800	13 >	•
800 Z 800 ABS	13 >	•
800 Z 800 E	13 >	•
800 Z e ABS	13 >	•
800 Z800 SUGOMI EDITION	16 >	•

**SUZUKI**

650 GLADIUS	09 >	•
-------------	------	---



**07H055.SD** 75.3 x 39.4 x 9.7

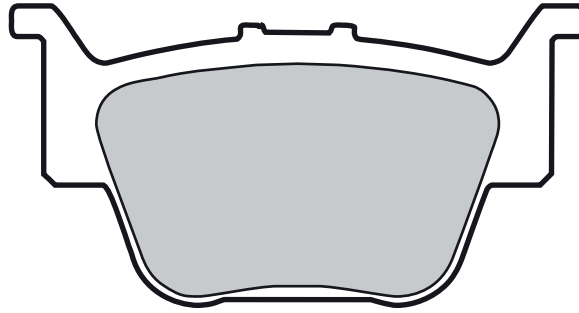

**HONDA**

420	TRX FA / FPA	09 >	•
450	TRX R	04 >	•
650	TRX FA RINCON	03 > 05	•
650	TRX FGA RINCON	04 > 05	•
680	TRX FA6 RINCON	06 >	•
680	TRX FGA6 RINCON	06 >	•



**07H056.06** 110.8 x 35.7 x 7.6  
98.1 x 32.7 x 7.6

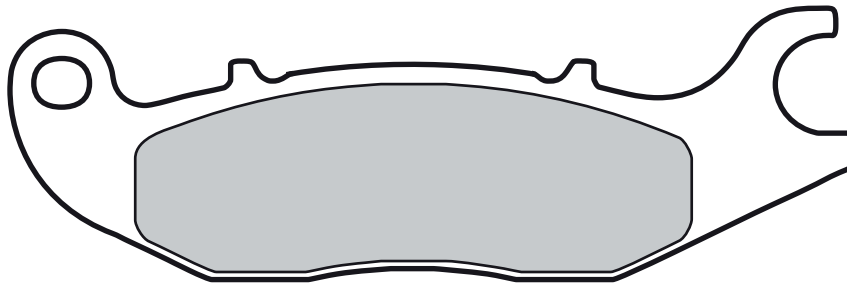
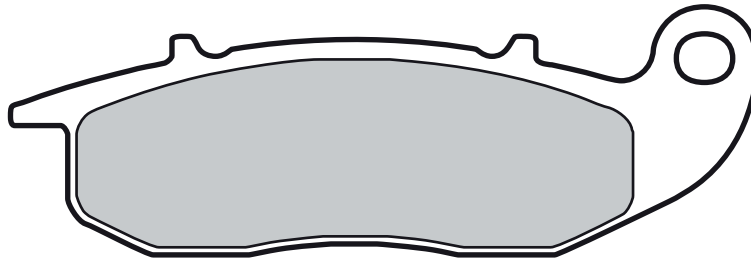

### HONDA

125 ANF INNOVA	03 >	•
125 CBF	09 >	•
125 CBR	12 >	•
125 CBR R	04 >	•
125 MSX	14 >	•
125 MSX GROM	14 >	•
150 CBR R	00 >	•



### PIAGGIO

125 MEDLEY	16 >	•
150 MEDLEY	16 >	•



### RIEJU

50 RS2 NKD	06 >	•
50 RS2 PRO	10 >	•
50 RS3	10 >	•
125 RS2 NKD	06 >	•



**07H057.SA** 117.6 x 44.9 x 8.8

**07H057.SP** “ “ “

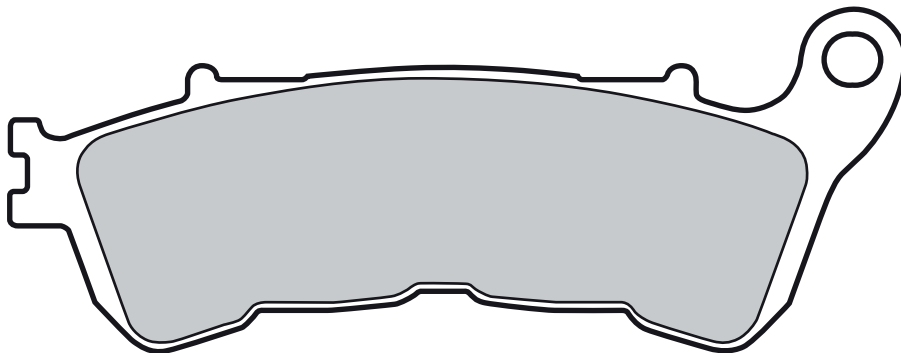
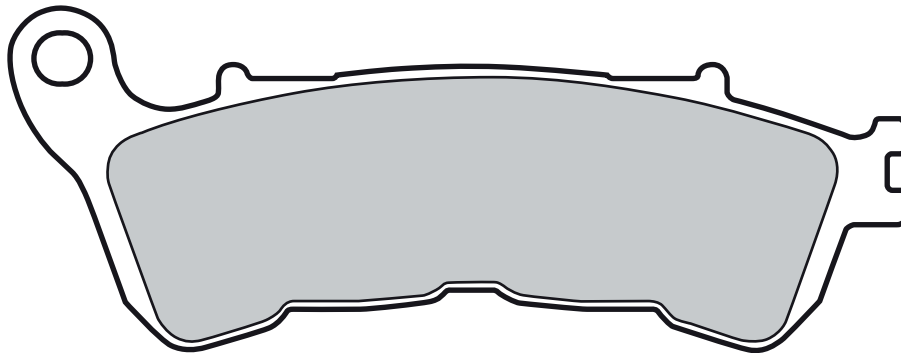

### HONDA

250	CBR R ABS	11 >	•
500	CBF ABS	04 >	•
600	CBF	08 >	•
600	CBF N ABS	08 > 11	•
600	CBF S ABS	08 > 12	•
600	CBR F ABS	11 >	•
600	HORNET ABS	07 >	•
680	DN-01	08 >	•
700	NC S	12 >	•
700	NC SA ABS	12 >	•
700	NC SD ABS	12 >	•
700	NT DEAUVILLE ABS	06 >	•

700	NT VARADERO ABS	10 >	•
700	TRX INTEGRA	12 >	•
700	XA ABS	12 >	•
700	XAD ABS	12 >	•
700	XL TRANSALP ABS	09 >	•
800	CROSSRUNNER	11 >	•
800	VFR V-TEC ABS	06 >	•
1000	CB R ABS	08 > 08	•
1000	CB R ABS	15 >	•
1000	CBF ABS	06 >	• •
1000	CBF F ABS	15 >	•
1000	CBF ST ABS	09 >	•
1000	CBF1000ST ABS	09 >	•

1000	XLV VARADERO ABS	04 >	•
1000	XLV VARADERO TRAVEL ABS	04 >	•
1100	CB	13 >	•
1200	CROSSTOURER	12 >	•
1237	VFR X CROSSTOURER	16 >	•
1300	CB	11 >	•
1300	CB S	11 >	•
1300	CTX	14 >	•
1300	FURY ABS	10 >	•

### SUZUKI

1800	C R INTRUDER	08 >	•
------	--------------	------	---



**07H058.SD** 81.4 x 38.9 x 10.1

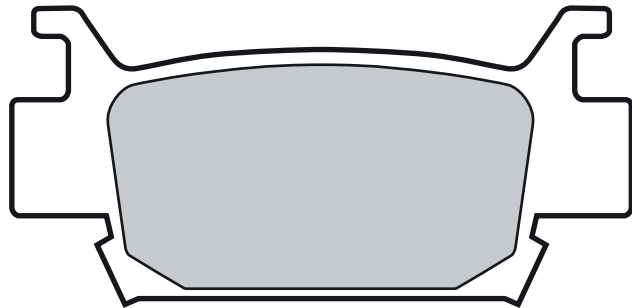

**HONDA**

500 TRX	05 >	•
700 TRX XX	08 >	•



**07H059.07** 77.2 x 41.7 x 8.9

**07H059.SP** “ “ “

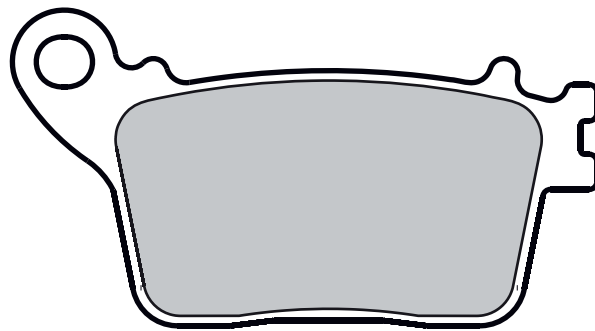

**HONDA**

600 CBR F	11 >	•
600 CBR F ABS	11 >	•
600 CBR F SPORT	11 > 12	•
600 CBR RR	07 >	•
600 CBR RR	09 >	•
600 CBR RR ABS	09 > 12	•
600 HORNET	07 >	•
1000 CBR RR	06 >	•
1000 CBR RR ABS	09 >	•
1000 CBR RR FIREBLADE	09 >	•
1000 CBR RR FIREBLADE ABS	09 >	•

1000 CBR RR SP

14 >



**KAWASAKI**

636 ZX-6R ABS	13 >	•
1000 ZX 10 R	11 > 15	•
1000 ZX 10 R	16 >	•
1000 ZX 10 R (ABS)	11 > 15	•
1000 ZX 10 R WINTER EDITION	16 >	•

**SUZUKI**

600 GSX-R	11 >	•
-----------	------	---

750 GSX-R

11 >



1000 GSX R

09 > 11



1000 GSX S 1000 F ABS

15 >



1000 GSX S ABS

15 >



**YAMAHA**

1000 MT-10	16 >	•
1000 YZF R1	15 >	•
1000 YZF R1M 60th ANNIVERSARY	16 >	•
1000 YZF R1M SPECIAL EDITION	15 >	•



**07H060.SP** 101.6 x 39.9 x 9.4

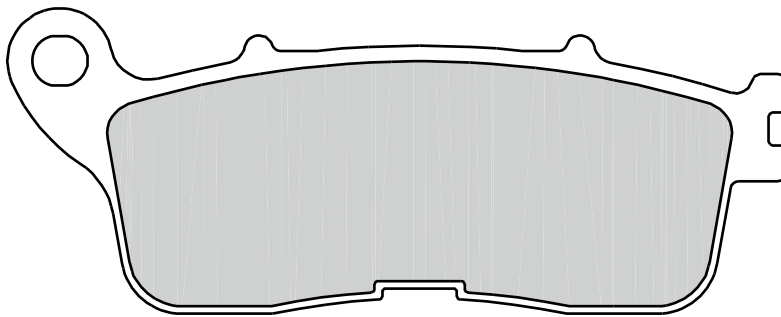
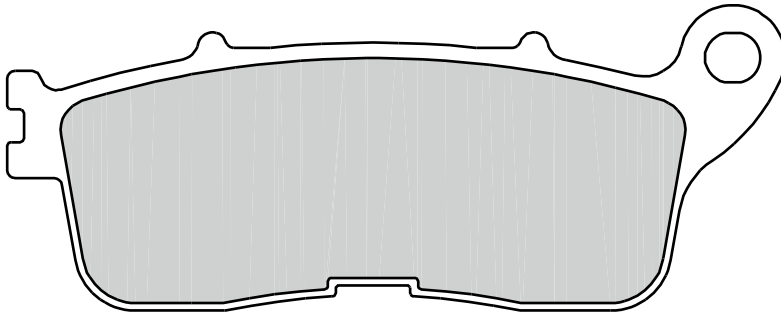

**HONDA**

1200 CROSSTOURER	12 >	•
1200 F W/DCT	10 >	•
1200 VFR FW	10 >	•
1237 VFR X CROSSTOURER	16 >	•





<b>07H061.CC</b>	88 x 40 x 10
<b>07H061.SD</b>	“ “ “
<b>07H061.SX</b>	“ “ “

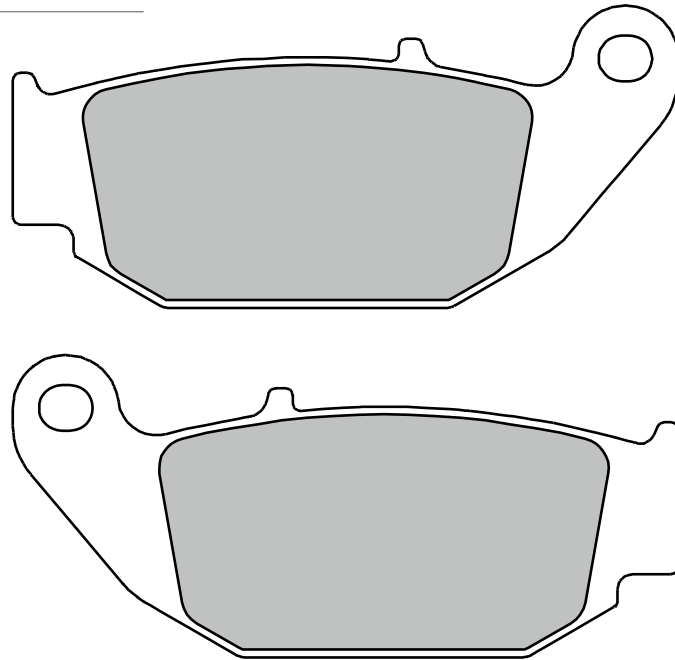

**HONDA**

125 CBR	12 >	•
125 MSX	14 >	•
125 MSX GROM	14 >	•
250 CRF L	14 >	•



<b>07H062.SA</b>	82.8 x 39.6 x 7.9
------------------	-------------------

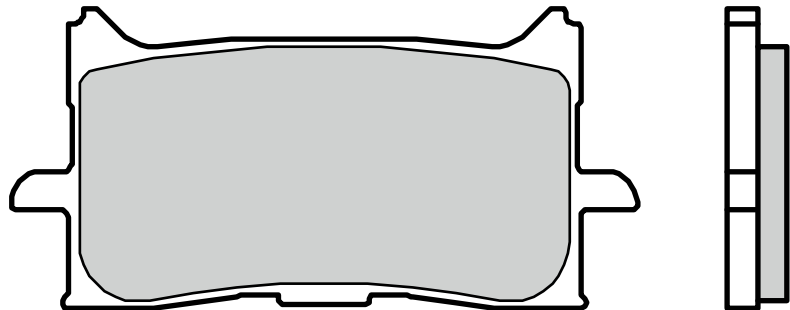

**HONDA**

1000 CRF L AFRICA TWIN	15 >	•
------------------------	------	---



**07KA01.22** 51 x 54.5 x 12.3  
50.5 x 42.6 x 12.5

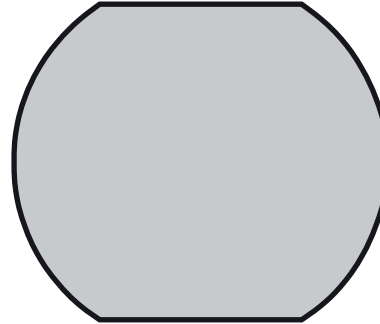
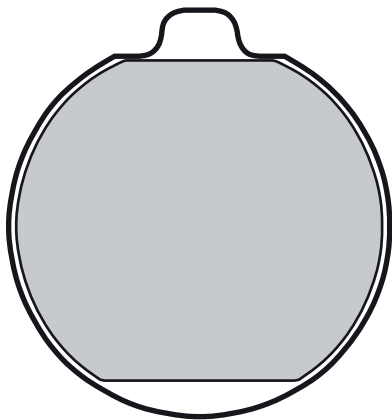

### KAWASAKI

250	KH A1, 2, B4, 5	76 > 80	•
400	KH	76 > 78	•
400	KZ	74 > 77	•
400	Z B1, B2	78 > 79	•
400	Z C1	80 >	•
400	Z E, GL, H, H1	79 >	•
440	KZ	80 > 82	•
440	Z C	80 > 82	•
440	Z C, LTD	80 > 81	•

500	KH A, B	76 > 79	•
500	Z B1, B2	79 > 80	•
550	KZ A1	80 >	•
650	Z	77 > 79	•
650	Z B1, B2, B3	77 > 79	•
650	Z C	78 > 80	•
650	Z C1, C2, C3	78 > 79	•
650	Z D1, D1A, D2, D3	78 > 82	•
650	Z E1, F1 LTD	80 >	•
750	Z B1	76 > 79	•
750	Z LTD	80 > 81	•

900	KZ A4, A5	76 >	•
900	KZ B1, LTD	76 >	•
900	Z A	76 > 77	•
1000	Z A1, A2, A3, A4	77 > 80	•
1000	Z B1, B2, B3, LTD	77 > 79	•
1000	Z C1, C2, C3, C4	78 > 81	•
1000	Z D1, D2, D3, Z1R	78 > 80	•
1000	Z GL	80 >	•
1000	Z R	76 > 79	•
1000	Z, H1	80 >	•





**07KA02.23**

51 x 54.5 x 12.3  
50.6 x 45 x 12.6

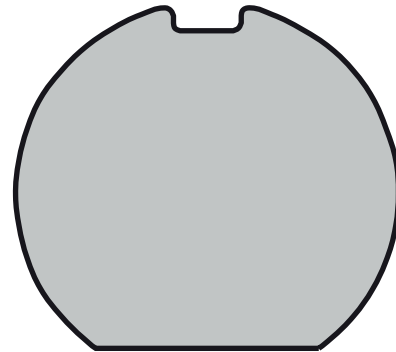
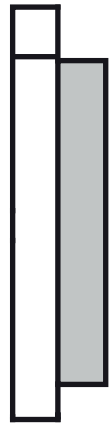
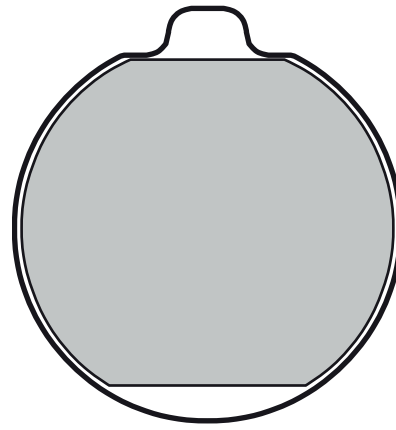

**KAWASAKI**

650	Z C1, C2, C3	78 > 79	•
750	Z B1	76 > 79	•
900	KZ B1, LTD	76 >	•
1000	Z B1, B2, B3, LTD	77 > 79	•



**07KA03.28**

51.6 x 50.7 x 16  
51.6 x 50.7 x 13.4

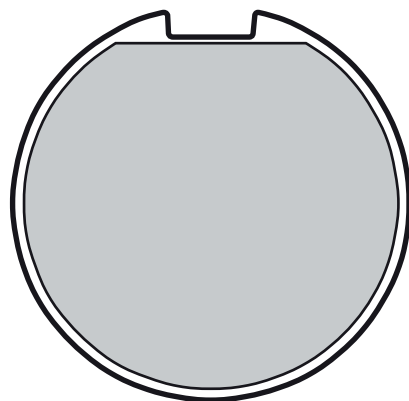

**KAWASAKI**

400	Z D,S	76 > 77	•
-----	-------	---------	---



**07KA04.14** 51 x 54.5 x 11

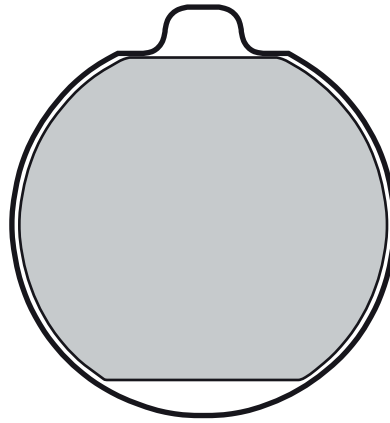

**KAWASAKI**

1300 Z	79 > 81	•
1300 ZA4, SPORTS	79 > 81	•
1300 Z DF1	84 >	•



**07KA05.06** 67.7 x 40.6 x 8

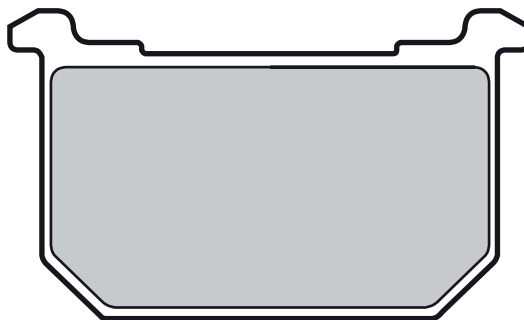

**KAWASAKI**

400 GPX	83 > 84	•
400 Z J	81 >	•
400 Z T	83 >	•
440 Z H	82 >	•
500 Z B3	81 > 83	•
550 Z C1, C2, LTD	80 > 81	•
550 Z D1, E, GP, LTD	81 >	•
550 Z LTD	81 >	•
650 Z D4, F2, F3, F4	81 > 83	•

650 Z F	81 >	•
700 ZA1, A1L	83 >	•
750 GPZ	81 > 82	•
750 ZA1, A1L	84 >	•
750 Z E	80 > 81	•
750 Z H1, H2, LTD	80 > 81	•
750 Z L	80 >	•
750 Z LTD	82 >	•
750 Z Y1, LTD	82 >	•
1000 KZ	87 > 01	•
1000 Z F1	80 >	•

1000 Z J	79 > 80	•
1000 Z J	81 >	•
1000 Z K, CSR, M, LTD	81 >	•
1000 Z MK2	79 >	•
1000 Z P1, P2, POLICE	82 > 84	•
1100 GPZ	81 > 86	•
1100 ZA1, B1, GP	81 >	•
1100 Z D1, D2, SPECTRE	82 > 83	•
1100 Z L1, LTD	83 >	•
1100 Z ST	81 >	•
1300 ZA4, SPORTS	82 >	•



**07KA06.08** 67.7 x 40.6 x 9.5

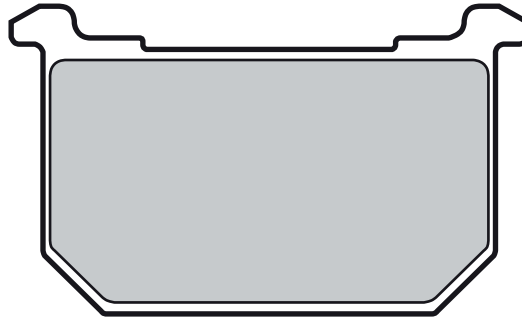

### KAWASAKI

250 Z	78 > 80	•	550 Z D1, E, GP, LTD	81 >	•	750 Z M1	82 >	•
250 Z J	81 >	•	550 Z F1, F2, F2L	83 > 84	•	750 Z R1	82 >	• •
305 KZ	81 > 88	•	550 Z GT, LTD	82 >	•	750 Z Y1, LTD	82 >	•
305 Z	81 >	•	550 Z M1, LTD	83 >	•	1000 KZ	87 > 01	•
305 Z A1, A2, B1, B2, B3	81 > 82	•	650 Z H1, H2, H3, CSR	81 > 82	•	1000 Z J	79 > 80	•
400 GPX	83 > 84	•	700 Z A1, A1L	83 >	•	1000 Z J	81 >	•
440 KZ	83 >	•	750 GPZ	81 > 82	•	1000 Z K, CSR, M, LTD	81 >	•
440 Z A4, A5, LTD	83 >	•	750 Z A1, A1L	84 >	•	1000 Z P1, P2, POLICE	82 > 84	•
440 Z H	82 >	•	750 Z E	80 > 81	•	1000 Z R1, R2	82 >	• •
440 Z LTD	83 >	•	750 Z GT, GPZ	82 >	• •	1100 GPZ	81 > 86	•
440 Z TWIN	81 >	•	750 Z H1, H2, LTD	80 > 81	•	1100 Z A1, B1, GP	81 >	•
500 Z B3	81 > 83	•	750 Z L	80 >	•	1100 Z B2, GP	82 >	•
550 Z A2, C3, LTD	81 > 82	•	750 Z L	84 >	• •	1100 Z D1, D2, SPECTRE	82 > 83	•
			750 Z L3	83 >	• •	1100 Z L1, LTD	83 >	•
			750 Z LTD	82 >	•	1300 Z A4, SPORTS	82 >	•



**07KA07.17** 84.9 x 42.4 x 7

47.4 x 37 x 9

**07KA07.SD** “ “ “

**07KA07.SX** “ “ “

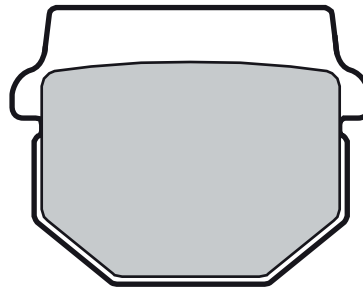
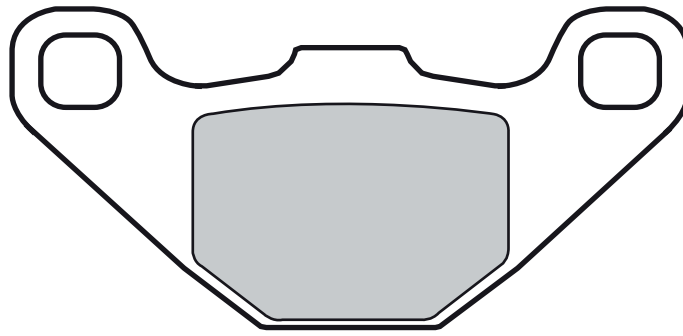

### ADLY

150 ATV	05 >	• •
150 INTERCEPTOR	05 >	• •
300 ATV	05 >	• •

### AEON

100 REVO 2	04 >	•
------------	------	---

### APRILIA

125 RS-4	12 >	•
125 RX ENDURO	08 >	•
125 RX SUPERMOTARD	08 >	•

### BOMBARDIER-CAN AM

90 DS X	08 >	• •
200 RALLY 2X4	03 > 04	•
200 RALLY 2X4	05 > 06	•

### CPI

250 XS QUAD	06 >	•
-------------	------	---

### DAELIM

250 ST SECTOR QUAD	05 > 06	•
--------------------	---------	---

### E-TON

250 ST VECTOR	06 >	•
250 VXL VECTOR	06 >	•
300 ST VORTEX	07 >	•
300 VTX VORTEX	07 >	•
VXL VECTOR, ST VECTOR	07 >	•

### FANTIC MOTOR

125 CABALLERO MOTARD AIRCOOLED	10 >	•
--------------------------------	------	---

### HERCULES

300 ATV SPORT	07 >	• •
---------------	------	-----

### HYOSUNG

110 KR MASTER	04 >	•
---------------	------	---

### KAWASAKI

50 AR	81 > 83	•
50 KMX	88 >	•
50 KSR I	90 >	• •
80 AR	81 > 83	•
80 KD	88 > 90	•
80 KSR II	90 >	• •
80 KX E, G, H, J	84 > 87	•
80 KX L, N, R	88 > 96	•
100 KX	88 > 96	•
125 KDX	90 >	•
125 KMX	86 > 86	•
125 KX	82 > 82	•
125 ZL ELIMINATOR	97 >	•
200 KMX	88 > 90	•
250 KXT A1 TECATE	84 >	•
570 KLR	88 >	•

### MALAGUTI

50 CENTRO 4T	11 >	•
--------------	------	---

### PETERSON

50 HURRICANE	95 >	•
50 SR	95 >	•
80 80 SR	95 >	•
80 HURRICANE	95 >	•

### PGO

50 BIG MAX	03 >	•
50 X-RIDER	03 >	•

125 X-RIDER	03 >	•
150 X-RIDER	03 >	•

### POLARIS

200 SAWTOOTH	06 >	• •
--------------	------	-----

### RIEJU

50 RS2 NKD	06 >	•
50 RS2 PRO	10 >	•
50 RS3	10 >	•
125 RS2 NKD	06 >	•
125 RS2 PRO	08 >	•

### SUZUKI

80 RM L, M, N	90 > 95	•
80 RM T	96 >	•
85 RM	02 > 04	•
110 ADDRESS	15 >	•
125 UE	01 >	•
500 LT R	88 >	•

### TGB

50 101 R	05 >	•
50 BULLET	09 >	•
50 RX	06 >	•

### TM

80 JUNIOR	96 > 00	•
-----------	---------	---

### ZERO

6 ZF DS	10 > 12	•
6 ZF S	10 > 12	•
9 ZF DS	10 > 12	•



**07KA08.08** 110.7 x 50.9 x 9.4  
68.7 x 43.3 x 9.8

**07KA08.SA** “ “ “

**07KA08.SP** “ “ “

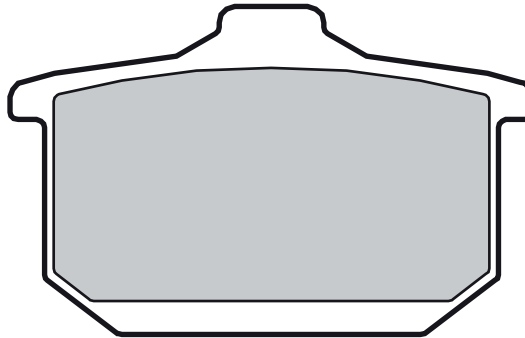
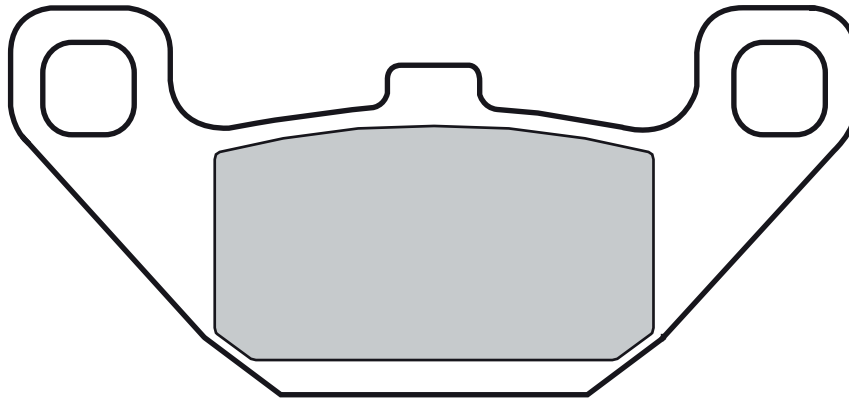

### HYOSUNG

300 GA 98 > •

### KAWASAKI

250 BR 86 > •  
250 CS 86 > •  
250 EL ELIMINATOR 88 > 94 •  
250 EX R NINJA 86 > 87 • •  
250 GPZ 83 > •  
250 GPZ R 86 > • •  
250 KR 85 > •  
250 LX ELIMINATOR 90 > •  
250 Z ELIMINATOR 88 > •  
252 EL 97 > 00 •  
305 EX 83 > •  
305 GPZ 83 > •  
400 ELIMINATOR 94 > •  
400 EN TWIN 85 > •  
400 FX R 86 > •  
400 GPX 85 > 86 •  
400 KLE VULCAN 90 > •  
400 Z ELIMINATOR 88 > • •  
400 ZX 85 > 85 • •  
400 ZX 86 > • •

450 EN 85 > 90 •  
450 Z 84 > •  
500 EN 90 > 98 •  
500 GPZ S 87 > 87 •  
500 GPZ S 88 > 92 •  
550 GPZ 84 > • •  
550 GT 85 > 89 •  
550 KZ A1, A1L 84 > • •  
550 Z F 85 > •  
550 ZX 84 > • •  
600 GPZ 83 > 93 • •  
600 GPZ R 85 > • •  
600 ZL 86 > •  
600 ZX NINJA 85 > 87 • •  
700 ZN A1, A1L 84 > • •  
750 GPZ 83 > 87 • •  
750 GT 86 > • •  
750 VN TWIN 88 > •  
750 VN VULCAN 86 > 96 •  
750 VULCAN 93 > •  
750 Z E1, E1L, TURBO 84 > • •  
750 Z ELIMINATOR 88 > • •  
750 Z K1, K2 83 > 84 • •  
750 Z LTD, K1, TWIN 83 > • •  
750 ZX A1, GP, E 83 > 85 • •

800 VN 95 > 95 •  
900 GPZ R 84 > 89 • •  
900 Z GPR 84 > • •  
900 ZL ELIMINATOR 85 > • •  
900 ZX A1, A1L 83 > 84 • •  
1000 GPZ RX 86 > • •  
1000 GTR 86 > 93 • •  
1000 Z R NINJA 86 > • •  
1000 ZG CONCOUR 86 > • •  
1000 ZL 86 > • •  
1100 GPZ 87 > 94 • •  
1100 Z GP 83 > • •  
1100 Z R, LTD 84 > • •  
1100 ZN B1, B1L, LTD 84 > • •  
1100 ZX A1, GP 83 > • •  
1200 ZG 87 > 96 • •  
1300 Z 85 > • •  
1300 Z 6 85 > • •  
1300 ZN A1, A2, A2L 83 > 84 • •  
1300 ZN VOYAGER 85 > • •  
1500 VN CLASSIC 97 > •  
1500 VN D1 VULCAN 87 > 96 • •  
1500 VN SE 91 > • •  
1500 VN SUMO 88 > • •



**07KA09.33** 141 x 41.7 x 8.5

95.2 x 34.6 x 9

**07KA09.SA** “ “ “

**07KA09.SP** “ “ “

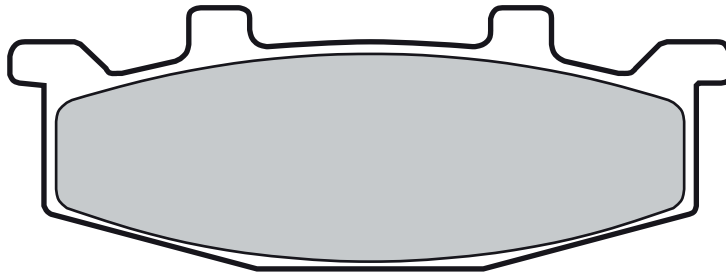
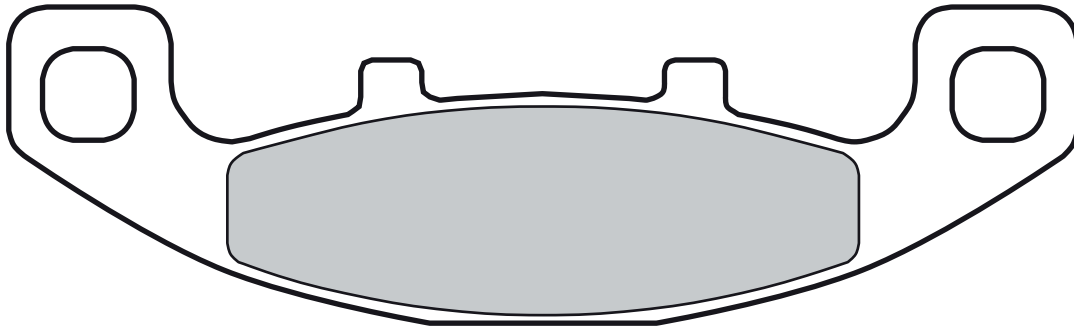

### HYOSUNG

250 GT COMET	02 > 02	•
600 COMET	02 > 02	•

### KAWASAKI

250 250 BALIUS	91 >	•
250 EX R NINJA	88 > 07	•
250 GPX R	88 >	•
250 ZZR R	90 >	•
400 ELIMINATOR	94 >	•
400 EX-4	95 >	•
400 GPX	87 > 88	•
400 GPX	89 >	•
400 GPZ S	88 >	•
400 KLE	91 >	•
400 LX ELIMINATOR	94 >	•
400 ZZ R	90 >	•
500 ER 5	97 > 00	•
500 EX	87 > 93	•
500 EX	94 > 96	•

500 KLE	91 > 98	•
550 ZR ZEPHYR	90 > 92	•
550 ZR ZEPHYR	93 > 95	•
600 GPX R	88 > 90	• •
600 GPZ	94 >	• •
600 ZL ELIMINATOR	95 > 98	•
600 ZX NINJA	88 > 95	• •
600 ZX-6	90 > 93	•
600 ZZR	90 > 92	•
650 KLR TENGAI	89 > 92	•
650 TENGAI	89 > 91	•
750 GPX R	86 > 87	• •
750 ZEPHYR	91 >	•
750 ZR ZEPHYR	91 > 95	•
750 ZR ZEPHYR left caliper	96 >	•
750 ZX 7 R	93 > 95	•
900 GPZ R	90 >	•
1000 GTR	94 > 97	• •
1000 GTR	98 >	•
1000 ZX 10	88 >	• •



1100 ZEPHYR left caliper	91 >	•
1100 ZR ZEPHYR	92 > 96	•
1100 ZZR	90 > 93	•

### SUZUKI

50 LIDO	91 >	•
125 RG WOLF	92 >	•
200 WOLF	92 >	•
250 ACROSS	90 >	•
250 DJEBEL	93 >	•
250 GSF BANDIT	90 > 93	•
250 GSX S, KATANA	91 >	•
250 SW1	92 >	•
400 GSF BANDIT	91 > 92	•
450 GS	90 >	• •
500 GS E	89 > 96	•
800 DR BIG	91 > 95	•
800 DR S	91 > 95	•
800 VX	90 > 93	•
1100 GSX G	94 > 95	•





**07KA10.TT**

73.4 x 49 x 6.7  
60.9 x 62.9 x 9

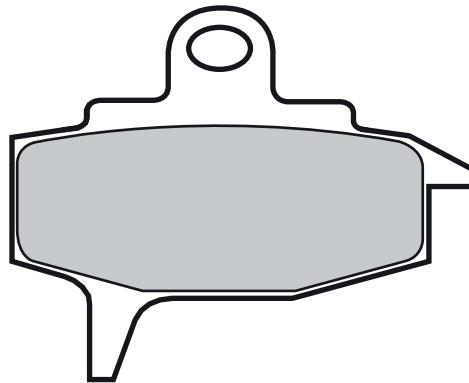
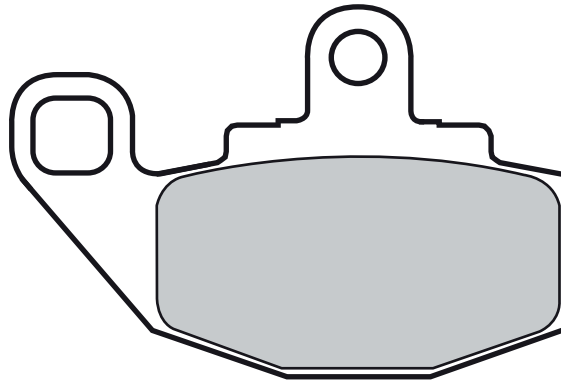

**KAWASAKI**

125 KX	87 > 88	•
250 KX	87 > 88	•
500 KX	87 > 88	•
650 KLR	87 > 89	•



**07KA11.17** 106.1 x 38.7 x 7.6  
76.2 x 27 x 9.6

**07KA11.SA** “ “ “

**07KA11.SP** “ “ “

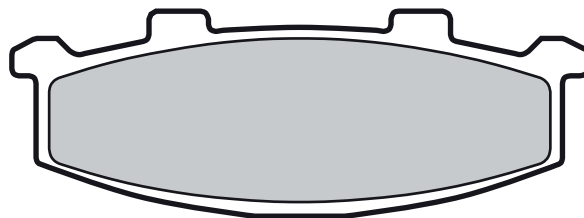
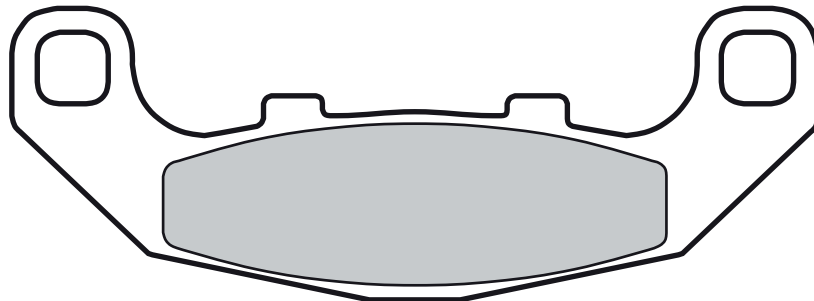

### KAWASAKI

250	EX R NINJA	88 > 07	•
250	GPX R	88 >	•
250	KR-1	88 > 89	• •
250	KR-1 S	90 >	•
250	ZZR R	89 > 89	• •
400	GPX	87 > 88	•
400	GPX	89 >	•

400 XANTHUS

92 > •

400 ZX 4

88 > 89 • •

500 EX E1-E3

94 > 96 •

500 GPZ S

97 > •

550 ZR ZEPHYR

90 > 92 •

750 ZR ZEPHYR

91 > 95 •

### SUZUKI

250	RGV GAMMA	91 > 92	•
1100	GSX G	94 > 95	•





<b>07KA12.SD</b>	62 x 40.7 x 8.7
<b>07KA12.SX</b>	“ “ “
<b>07KA12.TT</b>	“ “ “

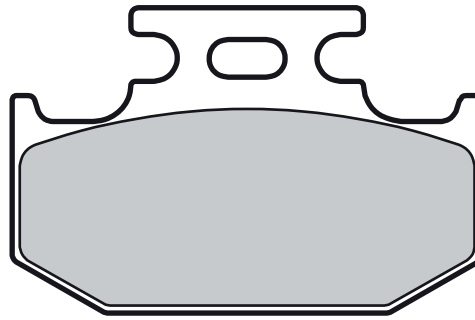

### CANNONDALE

400 MX	00 >	•
--------	------	---

### KAWASAKI

125 KDX	90 >	•
125 KX	89 > 93	•
125 KX	94 > 94	•
200 KDX	93 > 93	•
200 KDX	94 > 97	•
200 KDX SR	89 > 92	•
220 KDX	97 >	•
250 KDX D, SR	91 > 94	•
250 KLX	93 > 96	•
250 KX	89 > 93	•
250 KX	94 > 94	•

500 KX	89 > 93	•
500 KX	94 > 95	•
650 KLX R	93 > 95	•

### SUZUKI

125 RM X	89 > 90	•
125 TS R	89 >	•
200 TS R	90 >	•
250 DR S	90 > 95	•
250 RM	89 > 90	•
250 RM	91 > 95	•
350 DR, S	92 >	•

### YAMAHA

50 FZR	92 >	•
--------	------	---

80 YD	89 >	•
125 DT X SUPERMOTARD	05 >	•
125 WR	91 > 97	•
125 YZ	90 > 95	•
200 DT WR	91 >	•
200 WR	91 > 94	•
250 TRICKER	05 >	•
250 TT R	93 >	•
250 TY Z	96 >	•
250 WR	90 > 90	•
250 WR	92 > 97	•
250 YZ	90 > 91	•
350 TT	95 >	•
500 WR	92 > 93	•
600 TT	93 >	•



**07KA13.06** 69.7 x 46.2 x 8.1

**07KA13.SA** “ “ “

**07KA13.SC** “ “ “

**07KA13.RC** “ “ “

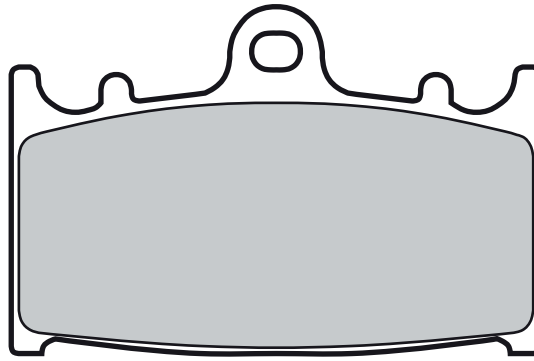

### HUSABERG

400 FS SUPERMOTARD	01 >	•
450 FSC SUPERMOTARD	03 >	•
450 FSE SUPERMOTARD	03 >	•
650 FSC SUPERMOTARD	01 >	•
650 FSE SUPERMOTARD	01 >	•

### KAWASAKI

250 KR-1 S	90 >	•
400 ZX 4	90 >	•
400 ZXR	89 > 90	•
400 ZZ R	90 >	•
500 GPZ S	93 > 94	•
600 GPZ NINJA	89 > 93	•
600 GPZ R	89 > 93	•
600 ZX-6	90 > 93	•
600 ZX-6R	93 > 97	•
600 ZZR	90 > 92	•
600 ZZR	93 >	•
750 ZX 7 R	93 > 95	•
750 ZX-7 NINJA	89 > 94	•

750 ZXR	89 > 92	•
750 ZXR R	93 > 95	•
900 GPZ R	90 >	•
900 ZX 9R	94 > 95	•
1000 VERSYS	12 >	•
1000 VERSYS LT	15 >	•
1100 ZR ZEPHYR	92 > 96	•
1100 ZX 11 R	93 > 96	•
1100 ZZR	90 > 93	•
1100 ZZR	94 > 01	•
1200 ZZR	02 >	•
1700 VN 1700 VOYAGER	09 >	•
2000 VN	04 >	•
2000 VN VULCAN	04 >	•

### SUZUKI

125 RG	92 >	•
125 RG F	92 >	•
125 RG GAMMA	92 >	•
200 RG GAMMA	91 >	•
250 COBRA	90 >	•
250 GSX-R S	89 >	•

250 RGV GAMMA	91 > 92	•
250 RGV GAMMA	93 >	•
250 RGV K	89 > 90	•
250 TV J	88 >	•
350 GOOSE	92 >	•
400 GSF BANDIT	93 > 93	•
400 GSX S, KATANA	92 >	•
400 GSX-R	88 > 89	•
400 SE	92 >	•
600 GSR	06 >	•
600 GSX-R	97 > 03	•
650 GSF ABS	07 >	•
650 GSF S ABS	07 >	•
650 GSX F	08 >	•
750 GSX-R	00 > 03	•
1000 SV	03 >	•
1000 SV S	03 >	•
1000 TL S	97 >	•
1250 GSF ABS	07 >	•
1250 GSF S ABS	07 >	•
1250 GSX F	10 >	•
1250 GSX FA	10 >	•



**07KA14.06** 58.9 x 43.6 x 7.9

**07KA14.SA** “ “ “

**07KA14.SC** “ “ “

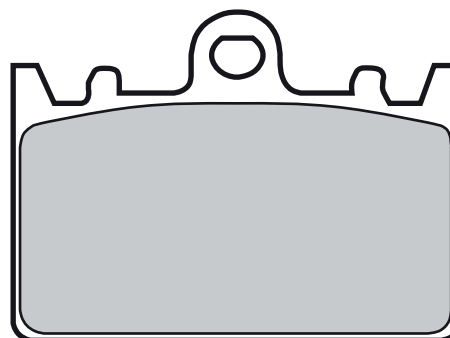

### KAWASAKI

400 ZXR R	91 > 02	•
-----------	---------	---



**07KA15.CC** 133.5 x 37.4 x 10.9  
109.2 x 44.4 x 10.9

**07KA15.SP** “ “ “

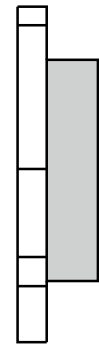
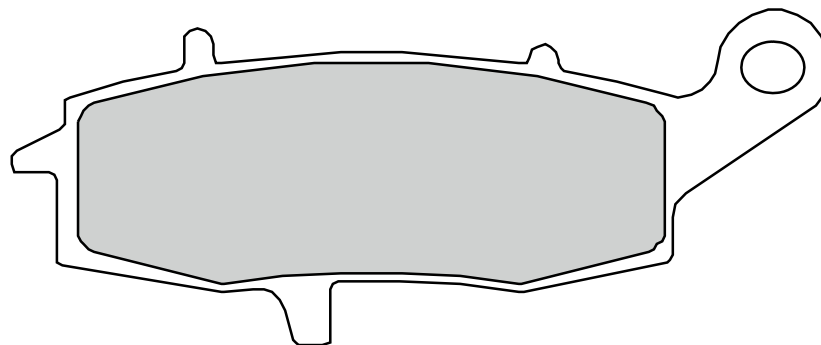
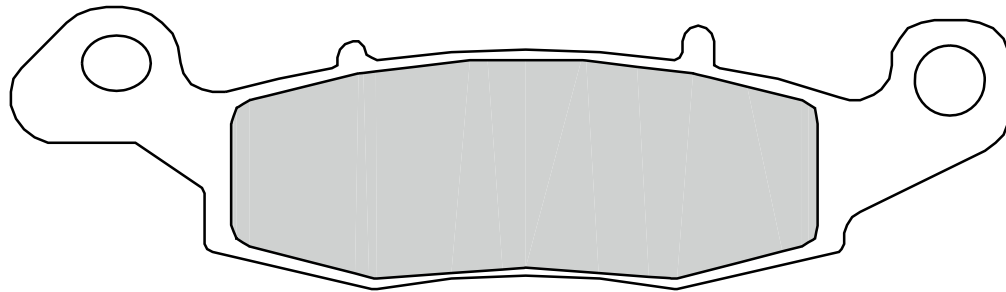

### KAWASAKI

900 CLASSIC SE	11 >	•
900 VN CLASSIC	06 >	•
900 VN CUSTOM	07 >	•
1500 VN CLASSIC FI	00 >	•
1500 VN CLASSIC TOURER FI left caliper	00 >	•
1500 VN DRIFTER	99 >	•

1500 VN MEAN STREAK	02 > 03	•
1600 VN CLASSIC left caliper	03 >	•
1600 VN MEAN STREAK	04 >	•
1600 VN MEAN STREAK	05 >	•
1700 VN 1700 VOYAGER	09 >	•
1700 VN CLASSIC left/rear	09 >	•
1700 VN CLASSIC TOURER left/rear	09 >	•

2000 VN	04 >	•
2000 VN VULCAN	04 >	•

### SUZUKI

1500 C INTRUDER	13 >	•
1500 INTRUDER M ()	09 > 12	•
1600 M INTRUDER	05 >	•
1600 VZ MARAUDER	04 >	•



**07KA16.17** 89.5 x 51.2 x 8.9  
68 x 52.6 x 9.9

**07KA16.SP** “ “ “

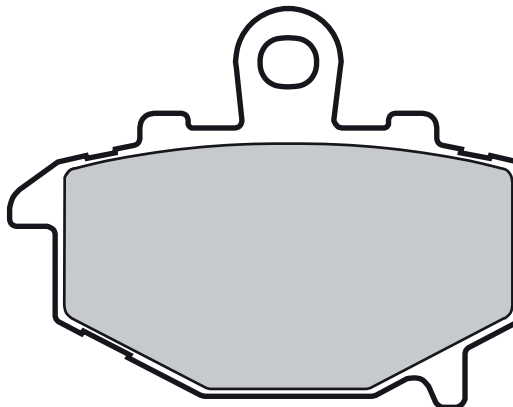
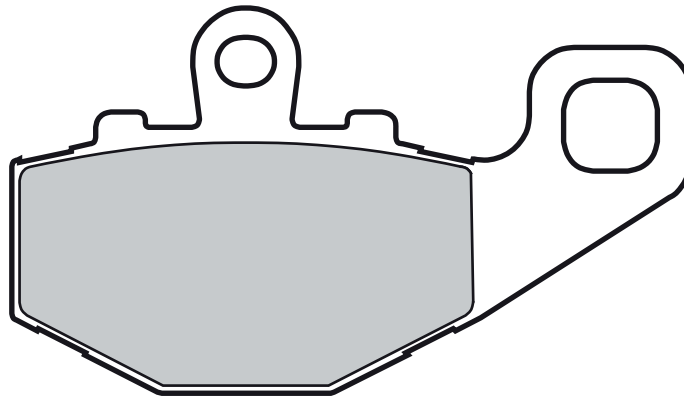

### KAWASAKI

400 NINJA R RIGHT CALIPER	11 >	•
550 ZR ZEPHYR	93 > 95	•
600 ZX-6R	93 > 97	•
600 ZX-6R	98 > 02	•
600 ZX-6R	03 > 04	•
600 ZX-6R	07 >	•
600 ZX-6R	09 >	•
600 ZX-6RR	05 > 06	•
600 ZZR	93 >	•
636 ZX-6R	05 > 06	•
636 ZX-6R	13 >	•
636 ZX-6RR	02 >	•

636 ZX-6RR	03 > 04	•
650 ER-6F ABS left/rear	16 >	•
650 ER-6F left/rear	06 > 15	•
650 ER-6N ABS left/rear	16 >	•
650 ER-6N left/rear	06 > 15	•
650 R NINJA LEFT CALIPER	06 >	•
650 VERSYS ABS	07 >	•
650 VERSYS LEFT CALIPER	07 >	•
750 Z 750 left caliper	04 > 06	•
750 Z 750 S left caliper	04 >	•
900 ZX 9R	94 > 95	•
900 ZX 9R	96 > 97	•
900 ZX 9R	98 > 98	•
900 ZX 9R	99 > 01	•

900 ZX 9R	02 >	•
1000 GTR	98 >	•
1000 Z	03 > 06	•
1000 Z	10 >	•
1000 Z SX	11 >	•
1000 Z SX ABS	11 >	•
1000 Z1000 SUGOMI EDITION	16 >	•
1000 ZX 10 R	04 > 07	•
1000 ZX 10 R	08 > 10	•
1000 ZX 10 R (ABS)	08 > 10	•
1100 GPZ ABS left caliper	97 >	•
1100 GPZ left caliper	95 > 96	•
1100 ZEPHYR left caliper	97 >	•
1100 ZR ZEPHYR left caliper	97 >	•



<b>07KA17.05</b>	94.2 x 34.2 x 7.2
<b>07KA17.SD</b>	“ “ “
<b>07KA17.SX</b>	“ “ “
<b>07KA17.TT</b>	“ “ “

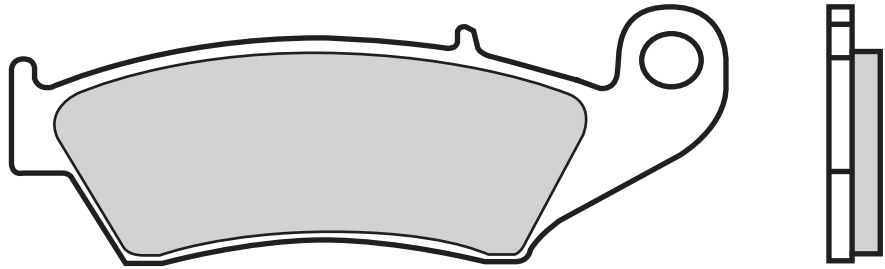

### APRILIA

450 MX V	09 >	•
450 RXV	06 >	•
550 RXV	06 >	•

### BETA

250 RR	05 >	•
250 RR ENDURO	05 >	•
300 RR CROSTRAINER	15 >	•
300 RR EFI	15 >	•
300 RR EFI RACING	15 >	•
300 RR ENDURO	13 >	•
350 RR ENDURO	12 >	•
390 RR	15 >	•
400 RR	05 >	•
400 RR ENDURO	05 >	•
430 RR	15 >	•
430 RR RACING	15 >	•
450 RR	05 >	•
450 RR CROSS COUNTRY	12 >	•
450 RR ENDURO	05 >	•
480 RR	15 >	•
480 RR RACING	15 >	•
498 RR ENDURO	12 >	•
525 RR	05 > 09	•
525 RR ENDURO	05 >	•

### BIMOTA

300 BBX ENDURO	12 >	•
508 BBX ENDURO	12 >	•

### CANNONDALE

400 MX	00 >	•
--------	------	---

### FANTIC MOTOR

50 MX REGOLARITÀ CASA	08 >	•
50 MX REGOLARITÀ COMPETIZIONE	08 >	•
50 SUPERSEI MOTARD	08 >	•



65 MX REGOLARITÀ COMPETIZIONE	08 >	•
85 MX REGOLARITÀ COMPETIZIONE	08 >	•
125 CABALLERO ENDURO	12 >	•
125 MX REGOLARITÀ CASA	08 >	•
125 SUPERSEI MOTARD	08 >	•

### GAS GAS

125 EC	00 >	•
125 MC	03 >	•
200 EC	00 >	•
200 HOBBY	07 >	•
250 EC	00 > 11	•
250 EC	12 >	•
250 MC	00 >	•
300 EC	00 > 11	•
300 EC	12 >	•
400 EC	02 >	•
400 PAMPERA	06 >	•
450 EC	03 >	•
450 FSE EC	03 >	•
450 FSR	07 >	•
500 FSE EC	06 >	•
515 FSR	08 >	•

### HM

125 CR SUPERMOTARD	04 >	•
125 CRE ENDURO	95 > 01	•
125 CRE R ENDURO	02 > 03	•
125 CRE SIX COMPETITION	11 >	•
125 CRE SUPERMOTARD	03 >	•
125 SUPERMOTARD	00 >	•
250 CRE ENDURO	95 > 01	•
250 CRE F ENDURO	04 >	•
250 CRE FX	08 > 11	•
250 CRE R ENDURO	02 >	•
250 CRE SUPERMOTARD	03 > 03	•
250 CRE SUPERMOTARD	04 >	•
250 CRE X	04 >	•



250 CRE X ENDURO	04 > 09	•
250 CRF X SUPERMOTARD	04 >	•
250 SUPERMOTARD	00 >	•
450 CRE F ENDURO	02 >	•
450 CRE X ENDURO	04 >	•
450 CRF F SUPERMOTARD	04 >	•
450 CRF R	04 > 09	•
450 CRF SUPERMOTARD	02 >	•
450 CRF X SUPERMOTARD	04 >	•
490 CRM F SUPERMOTO	07 > 07	•

### HONDA

125 CR E	02 >	•
125 CR R	02 >	•
125 CR RK	95 > 01	•
150 CRF	03 >	•
200 CTX	04 >	•
230 CRF	04 >	•
230 SL	97 >	•
250 CR E	02 >	•
250 CR R	95 > 01	•
250 CR R	02 >	•
250 CRE F	04 >	•
250 CRE X	04 >	•
250 CRF R	04 >	•
250 CRF R	14 >	•
250 XLR R, SPL	94 >	•
250 XR R, L, S	94 >	•
300 XR	10 >	•
400 XR	96 >	•
400 XR SUPERMOTARD	00 >	•
440 XR R	00 >	•
450 CRE F	02 >	•
450 CRF R	09 >	•
450 CRF X	05 >	•
450 CRF, E	02 >	•
450 TRX X	04 >	•
500 CR	95 > 01	•
600 XL V TRANSALP	97 > 99	•
600 XR R	93 >	•
600 XR R DAKAR	93 >	•



650 XL V TRANSALP	00 > •
650 XR L	93 > •
650 XR R	00 > •
700 TRX XX	08 > •
700 XL TRANSALP	08 > •
750 XRV AFRICA TWIN	93 > •

**KAWASAKI**

125 KX	94 > 94 •
125 KX	95 > •
200 KDX	94 > 97 •
220 KDX	97 > •
250 KLX	93 > 96 •
250 KLX	98 > •
250 KX	94 > 94 •
250 KX	95 > •
250 KX F	04 > •
300 KLX	97 > •
400 KLX R/SR	03 > •
450 KLX R	07 > •
450 KX F	06 > •
450 KX F	09 > •
500 KX	94 > 95 •
500 KX	96 > •
650 KLX R	93 > 95 •
650 KLX R	96 > 98 •

**SUZUKI**

125 DR SM	08 > •
125 RM T	96 > 05 •
250 DR Z	01 > •
250 RM T	96 > 05 •
250 RM Z	04 > •
250 RMX	99 > •
250 RMX T	96 > 98 •
350 DR V, M, X	97 > •
400 DRZ E	00 > 04 •
400 DRZ S	00 > 04 •
400 DRZ SM	05 > •
450 RM-Z	05 > •
450 RM-Z EFI	08 > •
450 RMX Z	10 > •
650 DR SE T-W	96 > 98 •

**YAMAHA**

125 WR	98 > 08 •
125 YZ	98 > 02 •
125 YZ	03 > 07 •
250 WR	98 > 02 •
250 WR F	01 > 02 •
250 WR F	03 > •
250 WR R	08 > •
250 YZ	98 > 02 •
250 YZ	03 > 07 •
250 YZ F	01 > 02 •

250 YZ F	03 > 06 •
400 WR F	98 > 98 •
400 WR F	99 > 00 •
400 YZ F	98 > 98 •
400 YZ F	99 > 02 •
426 WR F	01 > 02 •
426 YZ F	00 > 02 •
450 WR F	03 > •
450 YZ F	03 > 07 •

**ZERO**

2.8 ZF FX	13 > 13 •
2.8 ZF FX	14 > 14 •
2.8 ZF MX	13 > 13 •
2.8 ZF XU	13 > 13 •
5.7 ZF FX	13 > 13 •
5.7 ZF FX	14 > 14 •
5.7 ZF MX	13 > 13 •
5.7 ZF XU	13 > 13 •
8.5 ZF DS	13 > 13 •
8.5 ZF DS	14 > 14 •
8.5 ZF S	13 > 13 •
8.5 ZF S	14 > 14 •
11.4 ZF DS	13 > 13 •
11.4 ZF DS	14 > 14 •
11.4 ZF S	13 > 13 •
11.4 ZF S	14 > 14 •
11.4 ZF SR	14 > 14 •



**07KA18.07** 133.5 x 37.4 x 8.3  
109.2 x 44.4 x 8.3

**07KA18.SA** “ “ “

**07KA18.SP** “ “ “

**07KA18.SC** “ “ “

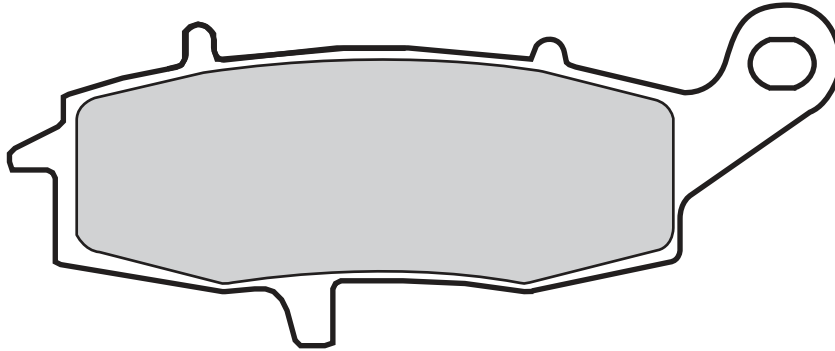
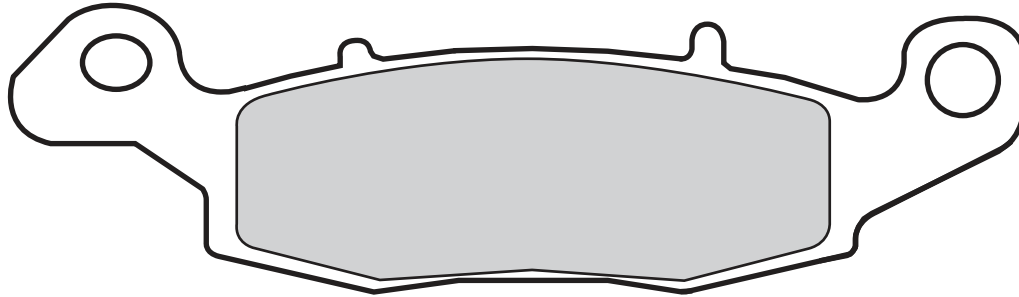

### KAWASAKI

400 NINJA R RIGHT CALIPER	11 >	•
650 ER-6F ABS right	16 >	•
650 ER-6F right	06 > 15	•
650 ER-6N ABS right	16 >	•
650 ER-6N right	06 >	•
650 R NINJA RIGHT CALIPER	06 >	•
650 VERSYS ABS	07 >	•
650 VERSYS RIGHT CALIPER	07 >	•
650 W	99 >	•
750 Z 750 right caliper	04 > 06	•
750 Z 750 S right caliper	04 >	•
750 ZR 7 right caliper	99 >	•
750 ZR 7S right caliper	01 >	•
750 ZR ZEPHYR right caliper	96 >	•
800 VN	96 > 97	•
800 VN DRIFTER	99 > 02	•
800 W	11 >	•
1000 KLV right caliper	04 >	•
1100 GPZ ABS right caliper	97 >	•
1100 GPZ right caliper	95 > 96	•
1100 ZEPHYR right caliper	97 >	•

1100 ZR ZEPHYR right caliper	97 >	•
1500 VN	02 >	•
VN CLASSIC TOURER FI right caliper	00 >	•
VN CLASSIC TOURER left caliper	98 >	•
VN CLASSIC TOURER right caliper	98 >	•
1500 VN NOMAD left/rear	00 >	•
1500 VN NOMAD right	00 >	•
1600 VN	04 >	•
VN CLASSIC right caliper	03 >	•
1600 VN CLASSIC TOURER	05 >	•
1700 VN CLASSIC right	09 >	•
VN CLASSIC TOURER right	09 >	•

### SUZUKI

125 VAN VAN	03 >	•
500 GS	04 >	•
500 GS E	96 > 03	•

500 GS F	04 >	•
600 GSF BANDIT S	00 > 04	•
600 GSX BANDIT	00 >	•
600 GSX FW	98 >	•
650 DL V STROM	04 >	•
650 DL V STROM XT (right)	15 >	•
650 GLADIUS	09 >	•
650 GSF BANDIT	05 >	•
650 GSF BANDIT S	05 >	•
650 SV	03 > 08	•
650 SV S	99 > 02	•
650 XF FREEWIND	97 >	•
750 GSR	11 >	•
750 GSX FW	98 > 02	•
800 INTRUDER M, C	05 >	•
800 VL INTRUDER	01 > 04	•
800 VZ MARAUDER	97 > 04	•
1000 DL V STROM	02 > 13	•
1100 GSX G	96 >	•
1500 C INTRUDER	05 >	•
1500 VL INTRUDER	02 >	•
1600 M95 BOULEVARD	05 >	•
1800 VRZ INTRUDER	06 >	•



**07KA19.07** 133.5 x 37.4 x 8.3  
109.2 x 44.4 x 8.3

**07KA19.SA** “ “ “

**07KA19.SC** “ “ “

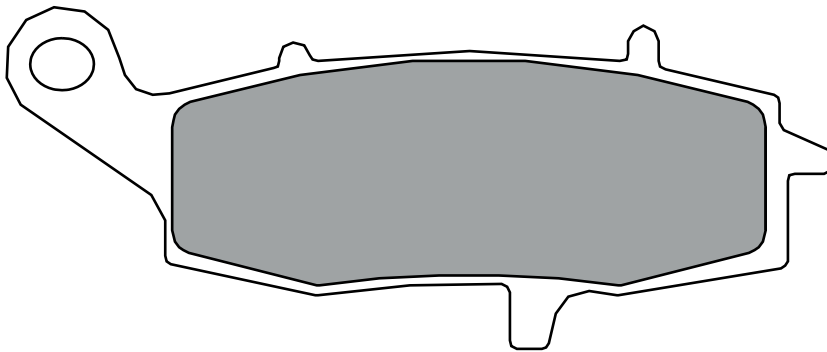
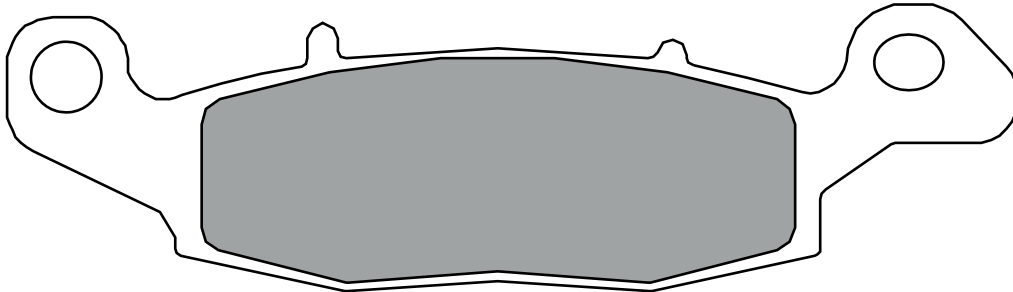

### KAWASAKI

400 NINJA R RIGHT CALIPER	11 >	•
500 ER 5	01 >	•
650 ER-6F ABS left/rear	16 >	•
650 ER-6F left/rear	06 > 15	•
650 ER-6N ABS left/rear	16 >	•
650 ER-6N left/rear	06 > 15	•
650 KLR	95 > 04	•
650 R NINJA LEFT CALIPER	06 >	•
650 VERSYS ABS	07 >	•
650 VERSYS LEFT CALIPER	07 >	•
750 Z 750 left caliper	04 > 06	•
750 Z 750 S left caliper	04 >	•
750 ZR 7 left caliper	99 >	•
750 ZR 7S left caliper	01 >	•
750 ZR ZEPHYR left caliper	96 >	•
800 VN CLASSIC	98 >	•
800 VN DRIFTER	99 > 02	•
900 CLASSIC SE	11 >	•
900 VN CLASSIC	06 >	•
900 VN CUSTOM	07 >	•

1000 KLV left caliper	04 >	•
1100 GPZ ABS left caliper	97 >	•
1100 GPZ left caliper	95 > 96	•
1100 ZEPHYR	97 >	•
1100 ZR ZEPHYR left caliper	97 >	•
1500 VN CLASSIC	97 >	•
1500 VN CLASSIC FI	00 >	•
1500 VN CLASSIC TOURER FI left caliper	00 >	•
1500 VN CLASSIC TOURER left caliper	98 >	•
1500 VN DRIFTER	99 >	•
1500 VN NOMAD left/rear	00 >	•
1600 VN CLASSIC left caliper	03 >	•
1700 VN CLASSIC left/rear	09 >	•
1700 VN CLASSIC TOURER left/rear	09 >	•

### SUZUKI

200 VAN VAN	16 >	•
250 GSF BANDIT	95 >	•

400 GSF BANDIT	94 >	•
600 GSF BANDIT S	00 > 04	•
600 GSX BANDIT	00 >	•
600 GSX FW	98 >	•
650 DL V STROM	04 >	•
650 DL V STROM XT (left/rear)	15 >	•
650 GLADIUS	09 >	•
650 GSF BANDIT	05 >	•
650 GSF BANDIT S	05 >	•
650 SV	03 > 08	•
650 SV S	99 > 02	•
750 GSR	11 >	•
750 GSX FW	98 > 02	•
800 DR ST BIG	96 >	•
1000 DL V STROM	02 > 13	•
1100 GSX G	96 >	•
1500 C INTRUDER (LET CALIPER)	05 >	•
1500 INTRUDER M ()	09 > 12	•
1500 INTRUDER M (RIGHT)	09 > 12	•
1500 VL INTRUDER	02 >	•





<b>07KA20.09</b>	91.6 x 51.4 x 8.2
<b>07KA20.SA</b>	“ “ “
<b>07KA20.SC</b>	“ “ “
<b>07KA20.RC</b>	“ “ “

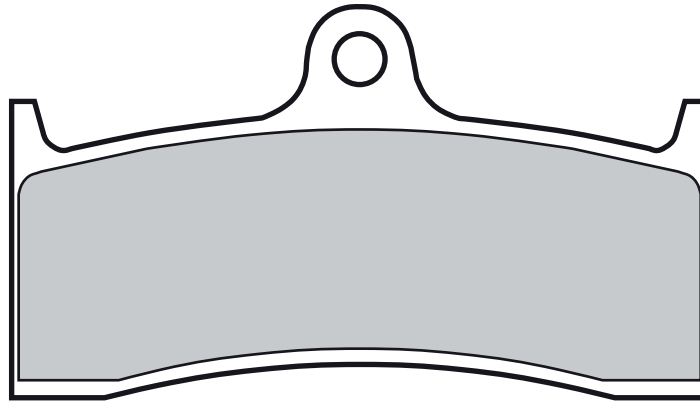

### BUELL

1200 M2	98 > 02	•
1200 M2 CYCLONE	98 > 02	•
1200 RS X1	98 >	•
1200 S1 LIGHTNING	98 > 02	•
1200 S1 WHITELIGHTWING	98 > 02	•
1200 S3 THUNDERBOLT	98 > 02	•
1200 S3T THUNDERBOLT	98 > 02	•
1200 X1	01 > 02	•

### HONDA

1300 CB SF	98 >	•
------------	------	---

### KAWASAKI

750 ZX-7 RR	96 > 02	•
900 ZX 9R	98 > 98	•

### MV AGUSTA

750 BRUTALE	03 >	•
750 BRUTALE AMERICA	04 >	•



750 BRUTALE GLADIO	05 >	•
750 BRUTALE MAMBA	05 >	•
750 BRUTALE ORO	02 >	•
750 BRUTALE S	02 >	•
750 F4	00 > 04	•
750 F4 AGO	03 >	•
750 F4 SPR	03 >	•
910 BRUTALE S	04 >	•
1000 F4 CORSE	05 >	•
1000 F4 MAMBA	03 >	•
1000 F4 S, 1+1	04 >	•
1000 F4 TAMBURINI	04 >	•





**07KA21.07** 59.7 x 57.1 x 8

**07KA21.SP** “ “ “

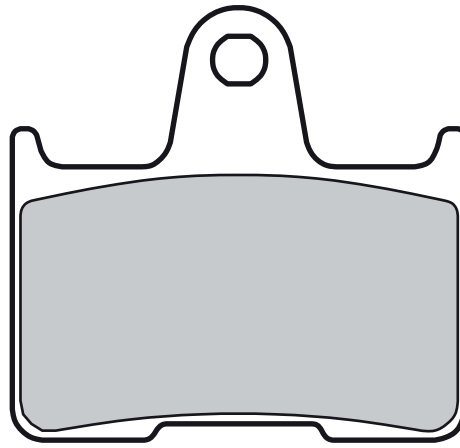

### HARLEY DAVIDSON

883	XL 883 R ROADSTER	14 >	•
883	XL L SUPER LOW	14 >	•
883	XL N IRON	14 >	•
883	XL N IRON DARK CUSTOM	16 >	•
883	XL R ROADSTER	14 >	•
1200	XL C SPORTSTER CUSTOM	14 >	•
1200	XL CA SPORTSTER CUSTOM	14 >	•
1200	XL CB SPORTSTER CUSTOM	14 >	•

1200 XL CP SPORTSTER  
CUSTOM

14 >



1200 XL T SUPER LOW

15 >



1200 XL V SEVENTY-TWO

14 >



1200 XL X FORTY EIGHT

14 >



### HONDA

1300	CB R	02 >	•
1300	CB SF	98 >	•
1300	CB X-4	97 >	•

### KAWASAKI

750	ZX-7 RR	96 >	02	•
1400	GTR	07 >		•
1400	ZZR	06 >		•
1400	ZZR ABS	06 >	15	•
1400	ZZR ABS	16 >		•

### MZ

1000	MUZ S	03 >		•
1000	MUZ SF	05 >		•
1000	MUZ SFX	07 >		•
1000	MUZ SN	05 >		•
1000	MUZ ST	07 >		•



**07KA22.SD** 119.5 x 26.4 x 7.3  
94.5 x 36.2 x 7.3

**07KA22.SX** “ “ “

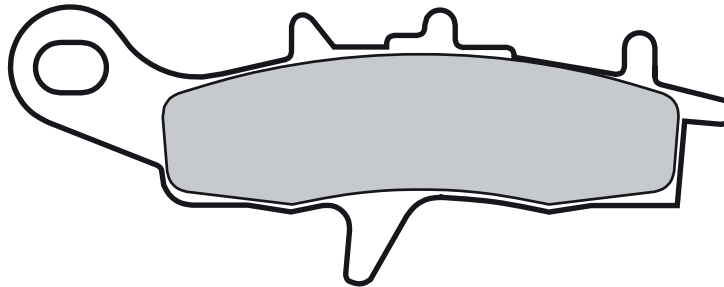
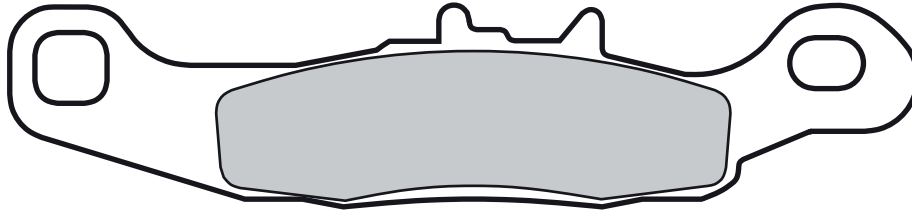

### KAWASAKI

80	KX R7, T7, W1, W2, Y1, Y2	97 > 00	•
85	KX, II	01 >	•
100	KX	97 >	•
250	KL SUPER SHERPA	00 >	•

### SUZUKI

85	RM	05 >	•
100	RM	03 >	•



<b>07KA23.05</b>	69.2 x 49.5 x 7
<b>07KA23.SA</b>	“ “ “
<b>07KA23.SC</b>	“ “ “
<b>07KA23.RC</b>	“ “ “

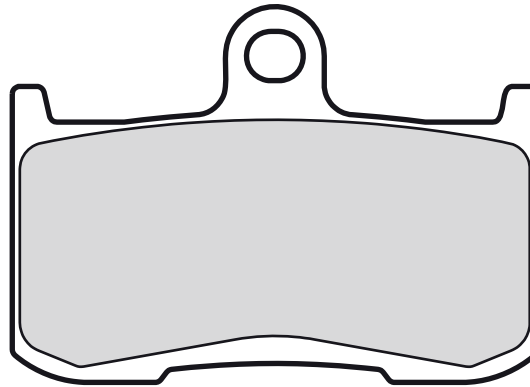

### INDIAN

1800 SCOUT	15 >	•
------------	------	---

### KAWASAKI

800 Z 800	13 >	•
800 Z 800 E	13 >	•
800 Z e ABS	13 >	•
800 Z800 SUGOMI EDITION	16 >	•
900 ZX 9R	02 >	•
1000 Z	03 > 06	•

### SUZUKI

1340 B-KING	08 >	•
-------------	------	---

### TRIUMPH

675 DAYTONA	06 > 08	•
-------------	---------	---

675 STREET TRIPLE R	09 >	•
675 STREET TRIPLE RX	15 >	•
1050 SPEED TRIPLE	05 > 07	•
1050 SPEED TRIPLE S	05 > 07	•
1050 TIGER	07 >	•
1050 TIGER SE	09 >	•
1050 TIGER SPORT	15 >	•

### VICTORY

1634 HAMMER	08 >	•
1634 KINGPIN ALL MODELS	08 >	•
1634 VEGAS	08 >	•
1634 VEGAS 8-BALL	08 >	•
1634 VEGAS JACKPOT	08 >	•
1731 BOARDWALK	13 >	•
1731 CROSS COUNTRY	10 >	•

1731 CROSS COUNTRY 8-BALL	14 >	•
1731 CROSS COUNTRY TOUR	12 >	•
1731 CROSS ROADS	10 >	•
1731 CROSS ROADS 8-BALL	14 >	•
1731 CROSS ROADS CLASSI	14 >	•
1731 HAMMER	09 >	•
1731 HAMMER 8-BALL	10 >	•
1731 HAMMER S	09 >	•
1731 HARD-BALL	12 >	•
1731 HIGH-BALL	12 >	•
1731 JACKPOT	10 >	•
1731 JUDGE	13 >	•
1731 KINGPIN	10 >	•
1731 KINGPIN 8-BALL	10 >	•
1731 VEGAS	10 >	•
1731 VEGAS 8-BALL	10 >	•
1731 VEGAS JACKPOT	09 >	•



**07KA24.SD** 94.4 x 35.8 x 7.4  
119.1 x 26 x 7.1

**07KA24.SX** " " "

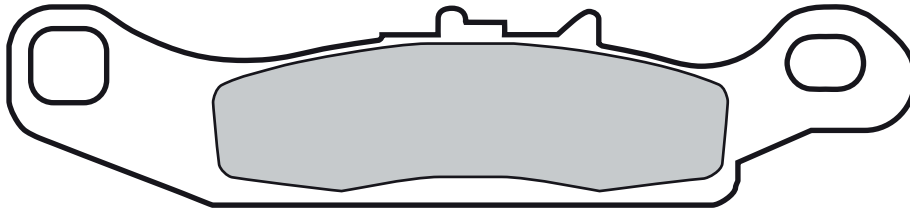
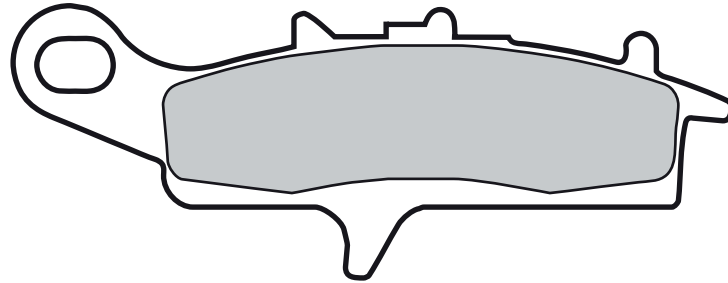

### KAWASAKI

450	KFX RIGHT CALIPER	07 >	•
650	KVX RIGHT CALIPER	01 > 03	•
700	KFX V-FORCE RIGHT CALIPER	04 >	•



700	KSV V-FORCE	04 >	•
700	KVF PRAIRIE right caliper	04 >	•
700	KVX RIGHT CALIPER	04 >	•



### SUZUKI

700	LT-V QUADRUNNER TWIN PEAKS	04 >	•
-----	----------------------------	------	---



**07KA25.SD** 94.4 x 35.8 x 7.4

119.1 x 26 x 7.1

**07KA25.SX** “ “ “

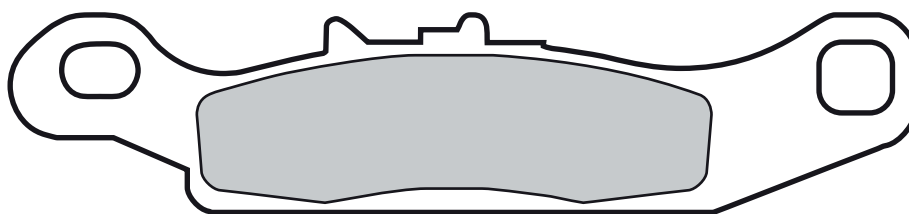
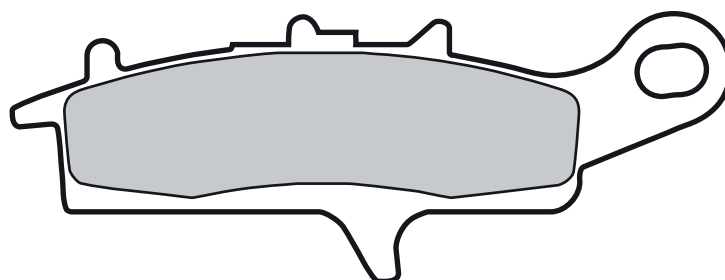

### KAWASAKI

450	KFX RIGHT CALIPER	07 >	•
650	KVX LEFT CALIPER	01 > 03	•
700	KFX V-FORCE LEFT CALIPER	04 >	•

700 KFX V-FORCE RIGHT CALIPER

04 > •

700 KVF PRAIRIE left caliper

04 > •

700 KVX LEFT CALIPER

04 > •

### SUZUKI

700	LT-V QUADRUNNER TWIN PEAKS	04 >	•
-----	----------------------------	------	---



**07KA26.SA** 81 x 45.9 x 7.7

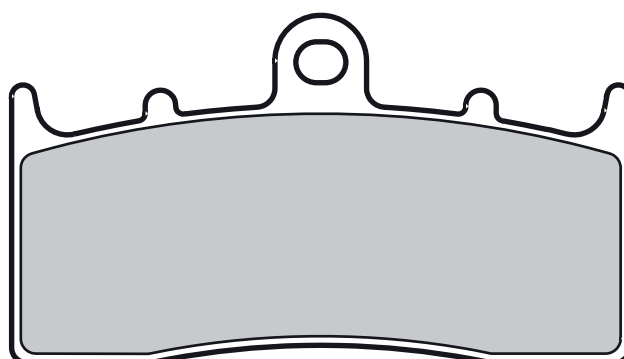

### KAWASAKI

400	ZRX	98 >	•
-----	-----	------	---



<b>07KA27.SD</b>	51.6 x 39.9 x 7.6
	67.5 x 36.5 x 7.6
<b>07KA27.SX</b>	“ “ “

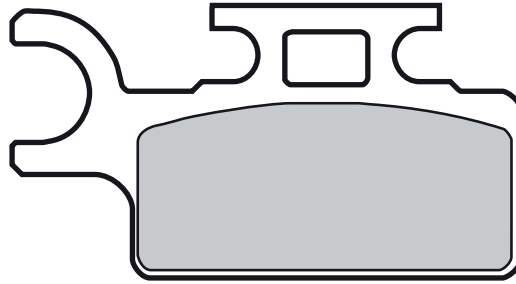
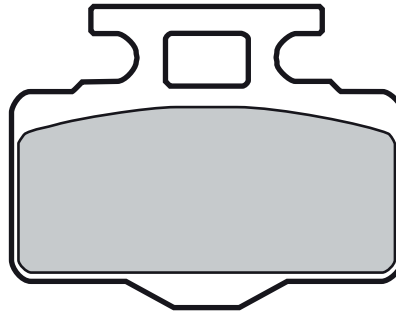

**KAWASAKI**

65	KX	00 >	•
----	----	------	---

**SUZUKI**

65	RM	03 >	•
----	----	------	---



<b>07KA28.SA</b>	37.4 x 49.5 x 7.8
<b>07KA28.SC</b>	“ “ “
<b>07KA28.RC</b>	“ “ “

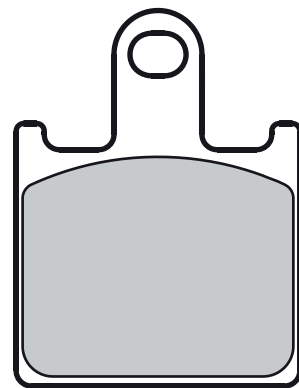

**KAWASAKI**

600	ZX-6R	07 >	•
600	ZX-6R	09 >	•
750	Z 750 R	11 >	•

750 Z 750 R ABS

1000	Z	11 > 12	•
		07 > 09	•
1400	GTR	07 >	•
1400	ZZR	06 >	•

1400 ZZR ABS

		06 > 15	•
--	--	---------	---

**SUZUKI**

1300	B-KING	07 >	•
------	--------	------	---



<b>07KA29.SA</b>	74.5 x 55.2 x 7.4
<b>07KA29.SC</b>	“ “ “
<b>07KA29.RC</b>	“ “ “

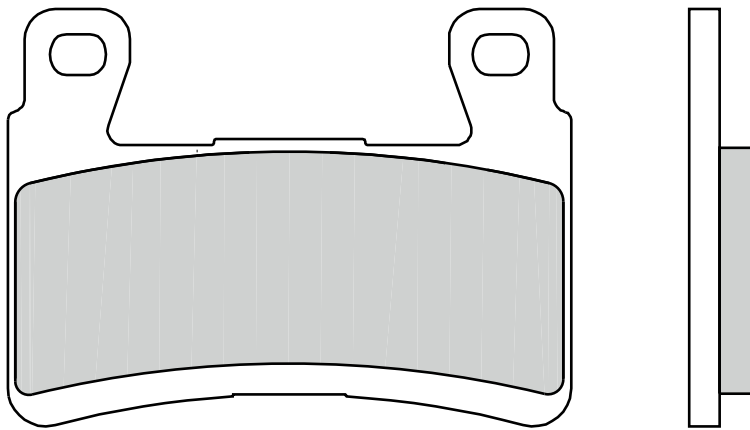

### KAWASAKI

636 ZX-6R	13 >	•
636 ZX-6R ABS	13 >	•



<b>07KS01.24</b>	50.3 x 50.3 x 12.5
	49.5 x 49.5 x 10

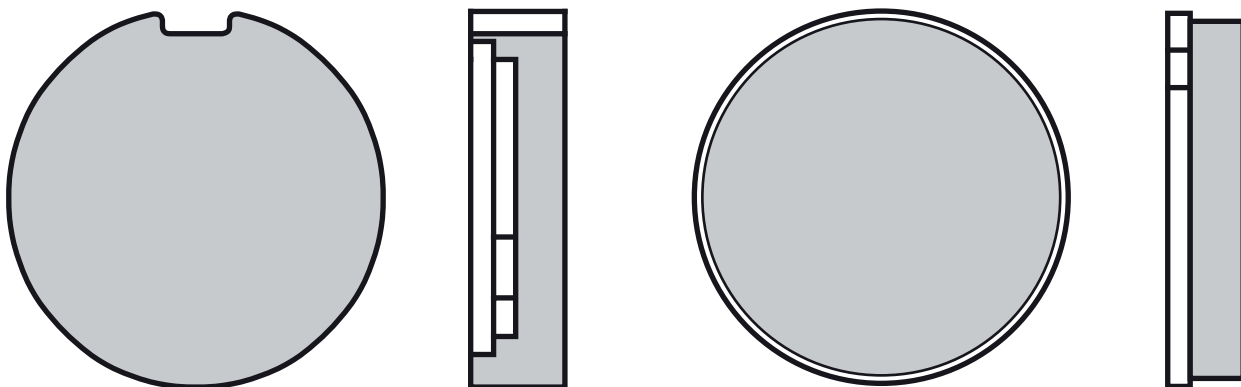

### KAWASAKI

400 S3, S3A	74 > 75	•
750 Z H2, H2A	72 > 73	•
900 Z Z1, Z11A, Z1B	73 > 75	•

### SUZUKI

RE 5 M, A	75 >	•
50 RM M, A	75 > 76	•
100 GT	78 >	•
125 GT A, B, C, L, M	75 > 78	•
185 GT	75 > 77	•

185 RG	75 > 77	•
250 GT	73 > 77	•
380 GT A, B, K, L, M	73 > 77	•
500 GT A, B	75 > 77	•
550 GT A, K, L, M	73 > 77	•
750 GT A, K, L, M	73 > 77	•





**07KS02.07** 58.1 x 53.9 x 9

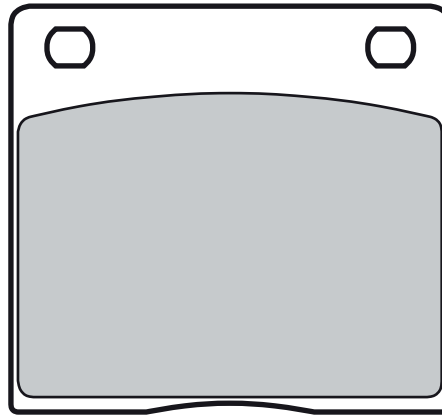

### KAWASAKI

500 Z B1, B2	79 > 80	•
650 Z D1, D1A, D2, D3	78 > 82	•
1000 Z A1, A2, A3, A4	77 > 80	•
1000 Z C1, C2, C3, C4	78 > 81	•
1000 Z D1, D2, D3, Z1R	78 > 80	•
1000 Z F1	80 >	•
1000 Z MK2	79 >	•
1000 Z R	76 > 79	•
1000 Z, H1	80 >	•
1100 Z ST	81 >	•
1300 Z	79 > 81	•
1300 Z DF1	84 >	•

### SUZUKI

250 GSX E, ET	80 > 81	•
250 GSX S	86 >	•
400 GSX ET, X, ST, SX	80 >	•
400 GSX F	81 >	•
400 GSX FOUR	81 >	•
400 GSX FWS	86 >	•
400 GSX FX	81 > 82	•
450 GS S	86 >	•
500 GS MX	81 >	•
550 GS DB	77 > 78	•
550 GS E	78 > 79	•
550 GS E, L, T, LX, LT, TX	80 >	•
550 GS EC	78 >	•

550 GS EM	81 > 84	•
550 GS EN, LN	79 >	•
550 GS ET, LT	80 > 81	•
550 GS LZ, MZ	82 >	•
550 GS ME, KATANA	81 >	•
650 GR E	83 >	•
650 GS EX, GLX, X, GX	81 >	•
650 GS EZ, GZ, GLZ	82 >	•
650 GS GD, G, MD, KATANA	83 >	•
650 GS GT	81 >	•
650 GS L	81 >	•
650 GS TURBO, XN	83 >	•
750 GS	76 > 77	•
750 GS B, C, EC	77 >	•
750 GS DB, EX, EN	77 >	•
750 GS ED, ESD	83 >	•
750 GS ET, LT, T	80 >	•
750 GS EX, LX, X	81 >	•
750 GS KATANA	85 >	•
750 GS L, N, LN	79 >	•
750 GS SD	83 >	•
750 GSX E	82 > 83	•
750 GSX E, EF, ET, EZ, EX, L, LT, LX	80 > 82	•
750 GSX ES	83 >	•
750 GSX ES, EF, STS	86 >	•
750 GSX KATANA	82 > 85	•
750 GSX KATANA	86 >	•
750 GSX S	82 > 85	•

750 GSX S	86 >	•
850 GS E, G, GT, GX, GLX, L	80 >	•
850 GS GD, GLD, TD	83 >	•
850 GS GL, GLT	81 >	•
850 GS GN, EN, GT	79 >	•
850 GS GZ, GLZ	82 >	•
850 GSX G	83 >	•
850 XN TURBO	82 >	•
1000 GS G, GLT, LT	80 >	•
1000 GS N, EN, HN, LN, SN	79 >	•
1000 GS S, HC, EC, EN	78 >	•
1000 GSX E, EZ, GKZ, S, SZ, X, KATANA	82 >	•
1000 GSX S, KATANA	82 >	•
1100 GS ED, ESD, GD, GKD, GLD, SD	83 >	•
1100 GS ET, L, LT, ST, T	79 > 80	•
1100 GS EX, LX, TX, X	81 >	•
1100 GS G	86 >	•
1100 GS GD, GKZ, GLD, GLZ, GZ	82 > 83	•
1100 GSX E, L	79 >	•
1100 GSX E, S	82 >	•
1100 GSX ES	82 >	•
1100 GSX ET	79 >	•
1100 GSX Z, ESD	86 >	•
1100 GT ET, T, LT, ST	80 >	•
1200 GV GLG MADURA	86 >	•
1400 GV CAVALCADE	85 >	•



**07KS03.21** 44.5 x 43.8 x 12.2  
43.4 x 43.4 x 9.5

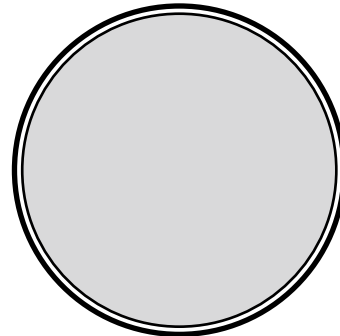
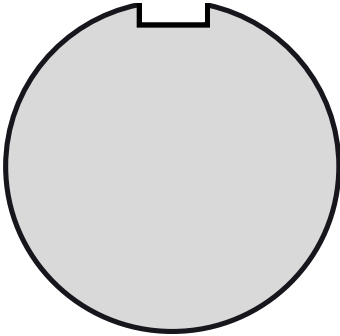

**KAWASAKI**

125 KH	77 > 80	•
200 KZ	78 > 79	•
200 Z	77 > 81	•

**SUZUKI**

50 AC DX	81 >	•
50 AC RG, RZ, Z1	79 >	•
50 GT K	81 >	•



50 GT K, KB	77 >	•
50 X1	79 >	•
50 ZR K	79 >	•



77 >	•
79 >	•
79 >	•



<b>07KS04.32</b>	84.9 x 42.4 x 7.5		
	55.8 x 37 x 9.8		
<b>07KS04.SD</b>	“ “ “		
<b>07KS04.SX</b>	“ “ “		
<b>07KS04.TT</b>	“ “ “		

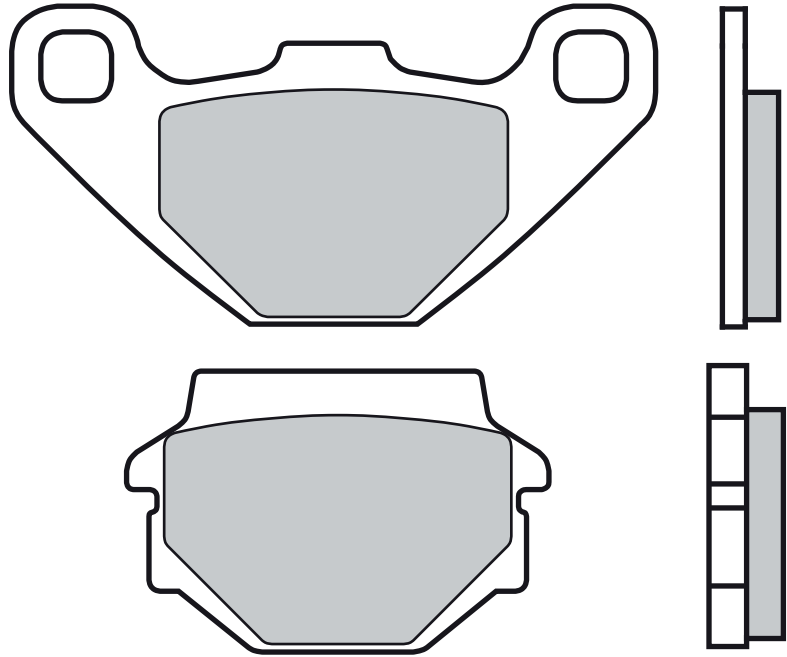

### BOMBARDIER-CAN AM

200 RALLY 2X4	05 > 06	•
---------------	---------	---

### KAWASAKI

100 KH GH, EX	83 >	•
125 AR	82 >	•
125 KE	86 >	•
125 KH	82 > 83	•
125 KMX	86 > 86	•
125 KMX	87 > 90	•
125 KX	83 > 85	•
125 KX	86 > 86	• •
125 KX	87 > 88	•
200 KDX	86 > 88	•
200 KDX SR	89 > 92	•
200 KMX	88 > 90	•
200 Z	83 >	•
250 250 BALIUS	91 >	•
250 ESTRELLA	92 >	• •
250 KL	85 > 97	•
250 KL SUPER SHERPA	00 >	•
250 KLR	84 > 86	•
250 KR	85 >	•
250 KX	83 > 85	•
250 KX	86 > 86	• •
250 KX	87 > 88	•
250 KXT A2, B1 TECATE	85 > 86	•
250 Z SCORPION	89 >	•
250 ZZR R	90 >	•
300 KLF B1-B13 BAYOU	88 >	•
305 GPZ	81 > 82	•
350 350 KLR	85 >	•
400 EX-4	95 >	•
400 FX R	86 >	•

400 GPX	85 > 86	•
400 KLE	91 >	•
400 LX ELIMINATOR	90 > 93	•
400 XANTHUS	92 >	•
400 Z F	84 >	•
400 ZR F, A1	83 > 84	•
400 ZX	85 > 85	•
500 EX	94 > 96	•
500 EX E1-E3	94 > 96	•
500 GPZ S	88 > 92	•
500 GPZ S	93 > 94	•
500 GPZ S	95 > 96	• •
500 GPZ S	97 >	•
500 KLE	91 > 98	•
500 KX	83 > 85	•
500 KX	86 > 86	• •
500 KX	87 > 88	•
500 LX A	83 >	•
500 ZR A1, F	83 >	•
550 550KX A	83 >	•
550 Z F	83 > 84	•
550 Z GT	83 >	•
550 ZR A1, GP	83 >	•
600 KL A1, A1L	84 > 86	•
600 KLR	84 > 86	•
600 KLR E	85 >	•
650 KLR	87 > 89	•
650 KLR	95 > 04	•
650 KLR TENGAI	89 > 92	•
650 TENGAI	89 > 91	•

### KYMC0

125 AGILITY R16	08 >	•
-----------------	------	---

### POLARIS

200 PHOENIX	05 > 09	•
200 PHOENIX	10 >	•

### SUZUKI

50 GSX-R	87 >	•
50 OR E	80 >	•
50 RB H	87 >	•
50 RG GAG	87 >	•
50 RG GAMMA	90 >	•
50 TV WOLF	91 >	•
50 ZR SAPX, SKX, SLK	81 >	•
80 GT L, X3E, EX, LX	81 >	•
80 RG GAMMA	87 > 87	•
118 TRS	82 > 83	•
125 GN	91 > 96	•
125 GS ESZ	82 >	•
125 GT T, ET	80 >	•
125 TR	83 >	•
125 X 3 E	70 >	•
125 X4	70 >	•
230 LT EH, S	86 > 93	•
240 ET	86 >	•
250 LT SF QUADRACER	85 >	•
250 NZ S	86 >	•
400 GSX	83 >	•
400 GSX EFX	82 >	•
400 GSX FD	83 >	•
400 GSX FOUR	81 >	•
400 GSX FX	81 > 82	•
450 GS S	86 >	•



**07KS05.07** 52.5 x 52.9 x 9  
**07KS05.SP** “ “ “

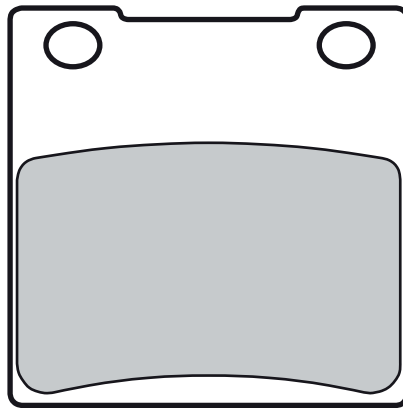

### HYOSUNG

250 GT COMET	02 > 02	•
600 COMET	02 > 02	•

### KAWASAKI

250 Z	78 > 80	•
250 Z J	81 >	•
400 ZX 4	90 >	•
400 ZXR	89 > 90	•
400 ZXR R	91 > 02	•
750 ZX 7 R	96 >	•
750 ZX-7 NINJA	89 > 94	•
750 ZXR	89 > 92	•
750 ZXR R	93 > 95	•
1100 ZRX	96 > 00	•
1100 ZX 11 R	93 > 96	•
1100 ZZR	94 > 01	•
1200 ZRX, R, S	01 >	•
1200 ZX12R NINJA	00 >	•
1200 ZX12R NINJA	04 >	•
1200 ZZR	02 >	•

### SUZUKI

125 RG GAMMA	90 >	•
250 ACROSS	90 >	•
250 COBRA	90 >	•
250 DJEBEL	93 >	•
250 GF S	88 >	•
250 GSF BANDIT	90 > 93	•
250 GSX FWS	85 >	•
250 GSX S, KATANA	91 >	•
250 GSX-R	88 >	•

250 GSX-R S	89 >	•
250 RG	83 >	• •
250 RG GAMMA	83 > 84	• •
250 RG GAMMA	85 > 87	•
250 RG GAMMA	88 >	•
250 RGV K	89 > 90	•
250 TV J	88 >	•
250 WOLF	90 >	•
350 GOOSE	92 >	•
400 GSF BANDIT	91 > 92	•
400 GSF BANDIT	93 > 93	•
400 GSX F	89 >	•
400 GSX IMPULSE	94 >	•
400 GSX S, KATANA	92 >	•
400 GSX SWS	84 >	• •
400 GSX X	86 >	•
400 GSX-R	87 > 87	•
400 GSX-R	88 > 89	•
400 GSX-R F	86 >	• •
400 GSX-R, RR	90 >	•
400 RF	93 >	•
400 SE	92 >	•
500 GS	04 >	•
500 GS E	89 > 96	•
500 GS E	96 > 03	•
500 GS F	04 >	•
500 GSX E	83 >	• •
500 RG GAMMA	85 > 89	•
500 RG RF	85 >	•
550 GS ED,ESD	83 >	• •
550 GS LD	83 >	• •
550 GSX ED	83 > 84	• •
550 GSX ES, EF	84 >	• •

600 GSF BANDIT	95 > 99	•
600 GSF BANDIT S	00 > 04	•
600 GSX BANDIT	00 >	•
600 GSX F	88 > 97	•
600 GSX FW	98 >	•
600 GSX-R	93 > 96	•
600 GSX-R	97 > 03	•
600 RF R	93 > 96	•
650 SV S	99 > 02	•
680 RG	86 > 87	•
750 GS RF	85 >	•
750 GSX F	89 > 95	•
750 GSX FW	98 > 02	•
750 GSX KATANA	89 > 95	•
750 GSX SE	84 > 85	• •
750 GSX-R	85 > 87	•
750 GSX-R	88 > 93	•
750 GSX-R	94 > 99	•
750 GSX-R	00 > 03	•
1000 TL R	98 >	•
1000 TL S	97 >	•
1100 GSX EF ESF	86 >	• •
1100 GSX G	96 >	•
1100 GSX KATANA, F	93 >	•
1100 GSX R	86 > 89	•
1100 GSX R	89 > 92	•
1100 GSX R	93 >	•
1200 GSF BANDIT	95 > 96	•
1200 GSF BANDIT	97 > 00	•
1200 GSF BANDIT	01 >	•
1200 GSF BANDIT S	01 >	•
1200 GSX	99 > 01	•
1300 GSX R HAYABUSA	99 > 07	•



**07P001.06** 96.6 x 39.1 x 7.1

**07P001.SD** “ “ “

**07P001.SX** “ “ “

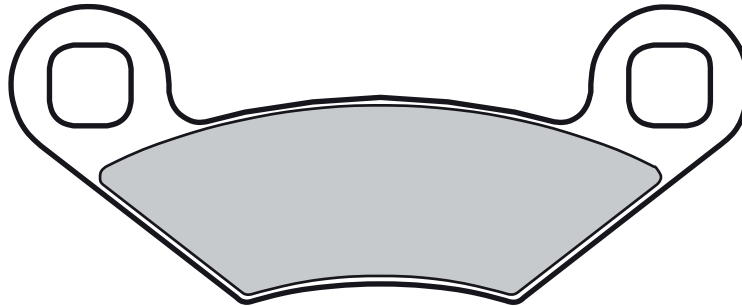

### POLARIS

250 TRAIL BOSS	88 > 90	•	450 OUTLAW S	08 >	•	600 SPORTSMAN	03 >	•
300 SPORTSMAN 4X4	08 >	• •	500 E SCRAMBLER	08 >	•	700 SPORTSMAN	02 >	•
325 XPEDITION	00 > 01	•	500 REVOLVER	06 >	• •	700 SPORTSMAN MV 700	05 >	•
325 XPEDITION	02 >	•	500 SPORTSMAN HO	03 >	•	800 RANGER RZR EFI	08 >	•
330 E TRIAL BLAZER	08 >	•	525 OUTLAW	07 >	•	800 RANGER RZR S EFI	09 >	•
450 OUTLAW MXR	09 >	•	525 OUTLAW IRS	08 >	•	800 RZR	08 >	•
			525 OUTLAW S	08 >	•	800 SPORTSMAN	05 >	•
			570 RANGER RZR EFI	12 >	•			



**07P002.SD** 97 x 39.6 x 7

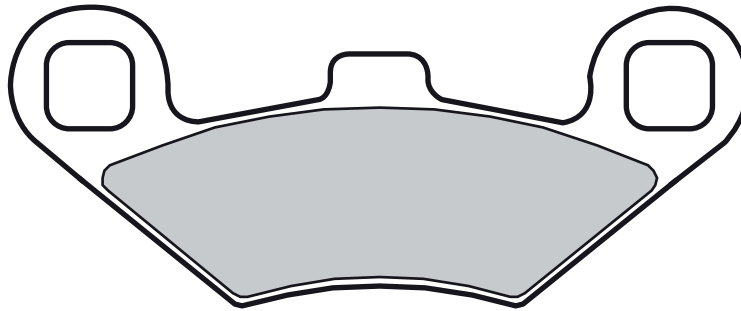

### POLARIS

200	PHOENIX	05 > 09	•
250	2X4, 4X4	90 >	•
250	2X4, 4X4	93 >	•
250	BIG BOSS 4X6, 6X6	89 > 93	•
250	TRAIL BLAZER	94 > 98	•
250	TRAIL BLAZER	99 >	•
250	TRAIL BOSS	91 > 99	•
250	TRAIL BOSS 2X4, 4X4	91 > 92	•
250	XPLORER 4X4	00 >	•
300	2X4, 4X4	94 > 95	•
300	BIG BOSS 6X6	94 >	•
300	HAWKEYE 2X4	06 >	• •
300	HAWKEYE 4X4	06 >	• •
300	XPLORER 4X4	96 >	•
300	XPRESS 2X4	98 >	•
300	XPRESS L	96 > 97	•
325	MAGNUM 2X4, 4X4	00 > 02	•
325	TRAIL BOSS	00 > 02	•
330	ATP	04 > 05	• •
330	ATP	06 >	•
330	MAGNUM 2X4, 4X4	03 >	•
330	TRAIL BOSS	03 >	•

335	SPORTSMAN 4X4	99 >	•
350	BIG BOSS	93 >	•
350	L 2X4, 4X4	90 >	•
350	SPORTSMAN 4X4	93 >	•
350	SPORTSMAN L 4X4	93 >	•
350	TRAIL BOSS L 2X4	91 > 93	•
350	TRAIL BOSS L 4X4	91 >	•
400	BIG BOSS L 6X6	96 >	•
400	L 2X4	94 > 95	•
400	SCRAMBLER 2X4	00 >	•
400	SCRAMBLER 4X4	98 > 98	•
400	SCRAMBLER 4X4	99 >	•
400	SCRAMBLER 4X4	00 >	•
400	SCRAMBLER L 4X4	94 >	•
400	SCRAMBLER L 4X4	95 > 97	•
400	SPORT	99 > 00	•
400	SPORT L	94 > 98	•
400	SPORTSMAN	01 >	•
400	SPORTSMAN L 4X4	94 > 97	•
400	TRAIL BLAZER	03 >	•
400	XPLORER L 4X4	95 > 99	•
400	XPLORER L 4X4	00 >	•
400	XPRESS L	96 > 97	•

425	2X4, 4X4 MAGNUM	95 > 98	•
425	MAGNUM 6X6	96 >	•
425	XPEDITION 4X4	00 >	•
450	SPORTSMAN	06 >	•
455	DIESEL EBS 4X4	99 >	•
500	ATP HO	04 >	• •
500	BIG BOSS 6X6	98 > 99	•
500	MAGNUM 2X4	02 >	•
500	MAGNUM 4X4	00 > 01	•
500	MAGNUM 4X4	02 >	•
500	OUTLAW	06 >	• •
500	PREDATOR	03 >	• •
500	PREDATOR E	06 >	•
500	RANGER 6X6	00 > 02	•
500	SCRAMBLER 2X4	01 >	•
500	SCRAMBLER 4X4	97 > 97	•
500	SCRAMBLER 4X4	98 >	•
500	SPORTSMAN 4X4	96 >	•
500	SPORTSMAN 6X6	00 >	•
500	SPORTSMAN EBS 4X4	98 >	•
500	XPLORER 4X4	97 >	•
800	TRAIL BLAZER	90 > 93	•
800	TRAIL BOSS 2X4, 4X4	88 > 89	•



**07P003.SD** 72.8 x 43.9 x 7  
**07P003.SX** " " "

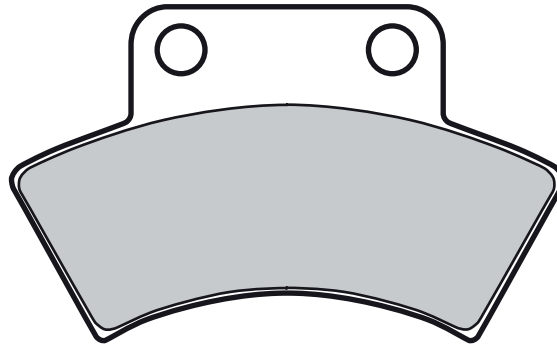

### POLARIS

250	2X4, 4X4	90 >	•
250	2X4, 4X4	93 >	•
250	BIG BOSS 4X6, 6X6	89 > 93	•
250	BIG BOSS 4X6, 6X6 MIDDLE AXLE BRAKE	89 > 93	•
250	TRAIL BLAZER	94 > 98	•
250	TRAIL BOSS	91 > 99	•
250	TRAIL BOSS 2X4, 4X4	91 > 92	•
300	2X4, 4X4	94 > 95	•
300	BIG BOSS 6X6	94 >	•
300	BIG BOSS 6X6 MIDDLE AXLE BRAKE	94 >	•
300	XPLORER 4X4	96 >	•

300	XPRESS 2X4	98 >	•
300	XPRESS L	96 > 97	•
350	BIG BOSS	93 >	•
350	BIG BOSS MIDDLE AXLE BRAKE	93 >	•
350	L 2X4, 4X4	90 >	•
350	SPORTSMAN 4X4	93 >	•
350	SPORTSMAN L 4X4	93 >	•
350	TRAIL BOSS L 2X4	91 > 93	•
350	TRAIL BOSS L 4X4	91 >	•
400	BIG BOSS L 6X6	96 >	•
400	L 2X4	94 > 95	•
400	SCRAMBLER 4X4	98 > 98	•
400	SCRAMBLER L 4X4	94 >	•

400	SCRAMBLER L 4X4	95 > 97	•
400	SPORT L	94 > 98	•
400	SPORTSMAN L 4X4	94 > 97	•
400	XPLORER L 4X4	95 > 99	•
400	XPRESS L	96 > 97	•
425	2X4, 4X4 MAGNUM	95 > 98	•
500	BIG BOSS 6X6	98 > 99	•
500	BIG BOSS 6X6 MIDDLE AXLE BRAKE	98 > 99	•
500	SCRAMBLER 4X4	97 > 97	•
500	SPORTSMAN 4X4	96 >	•
500	XPLORER 4X4	97 >	•
800	TRAIL BLAZER	90 > 93	•
800	TRAIL BOSS 2X4, 4X4	88 > 89	•



**07P004.SD** 73.9 x 53.2 x 6.8  
**07P004.SX** " " "

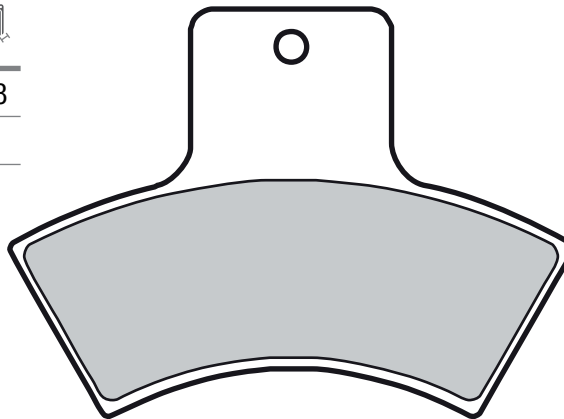

### POLARIS

250	TRAIL BLAZER	99 >	•
250	XPLORER 4X4	00 >	•
325	MAGNUM 2X4, 4X4	00 > 02	•
325	TRAIL BOSS	00 > 02	•
325	XPEDITION	00 > 01	•
330	TRAIL BOSS	03 >	•

335	SPORTSMAN 4X4	99 >	•
400	SCRAMBLER 2X4	00 >	•
400	SCRAMBLER 4X4	99 >	•
400	SCRAMBLER 4X4	00 >	•
400	SPORT	99 > 00	•
400	SPORTSMAN	01 >	•
400	TRAIL BLAZER	03 >	•
400	XPLORER L 4X4	00 >	•

425	MAGNUM 6X6	96 >	•
425	XPEDITION 4X4	00 >	•
455	DIESEL EBS 4X4	99 >	•
500	MAGNUM 4X4	00 > 01	•
500	SCRAMBLER 2X4	01 >	•
500	SCRAMBLER 4X4	98 >	•
500	SPORTSMAN EBS 4X4	98 >	•



**07P005.SX** 123.6 x 54.8 x 9.2

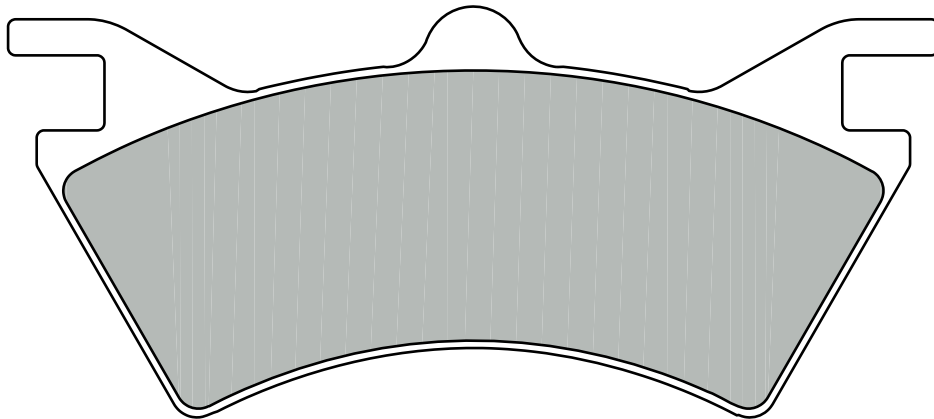

**POLARIS**

500 SPORTSMAN 6X6 00 > •



**07P006.SD** 90.2 x 37.9 x 8

**07P006.SX** “ “ “

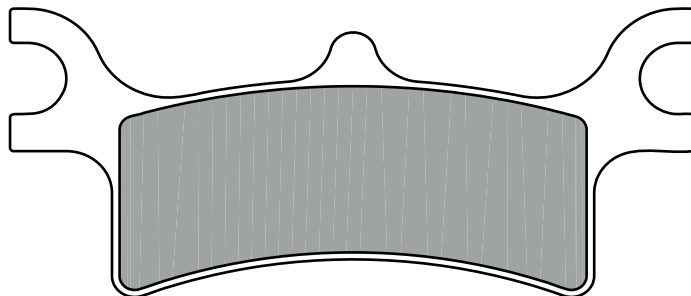

**POLARIS**

325 XPEDITION 02 > •  
 330 ATP 06 > •  
 330 E TRIAL BLAZER 08 > •  
 330 MAGNUM 2X4, 4X4 03 > •

450 SPORTSMAN 06 > •  
 500 E SCRAMBLER 08 > •  
 500 MAGNUM 2X4 02 > •  
 500 MAGNUM 4X4 02 > •  
 500 PREDATOR E 06 > •

500 SPORTSMAN HO 03 > •  
 600 SPORTSMAN 03 > •  
 700 SPORTSMAN 02 > •  
 700 SPORTSMAN MV 700 05 > •  
 800 SPORTSMAN 05 > •





**07P007.SD** 96.6 x 50.5 x 6.8

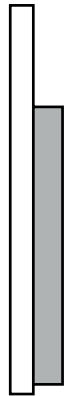
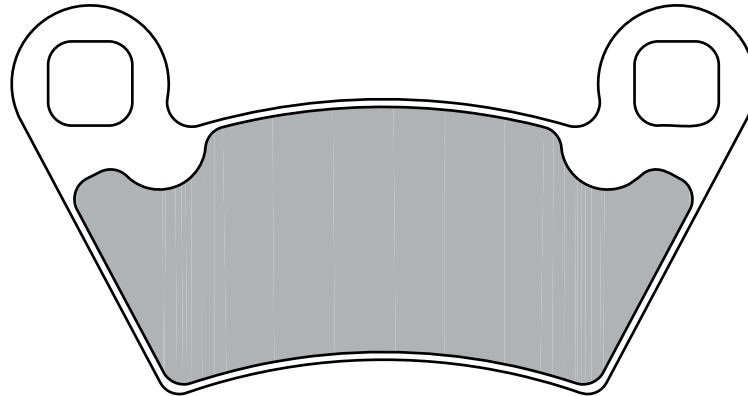

**POL**

700 RANGER 6X6 EFI 12 > •

**POLARIS**

RANGER XP 06 > • •

500 RANGER 2X4 08 > •

500 RANGER 2X4 EFI 08 > •

500 RANGER 4X4 12 > •

800 EV-LSV 10 > •

800 LSV 4X4 11 > •

800 RANGER 2X4, 4X4, 6X6 02 > • •

800 RANGER 48V EV 13 > •

800 RANGER RZR4 EFI 12 > •

800 RANGER XP 12 > •

800 RZR 4 10 > •



**07P008.SD** 50 x 60.4 x 6.8

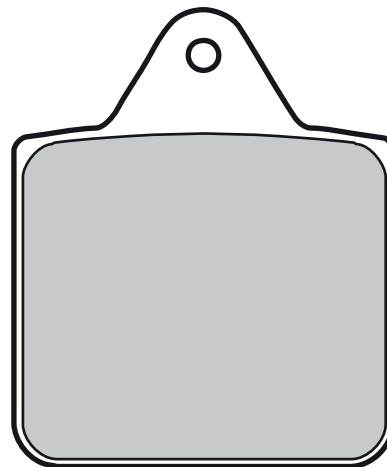

**POLARIS**

400 BIG BOSS L 6X6 MIDDLE AXLE BRAKE 96 > •

425 MAGNUM 6X6 MIDDLE AXLE BRAKE 96 > •



**07P009.SD** 96.2 x 46.8 x 7.6

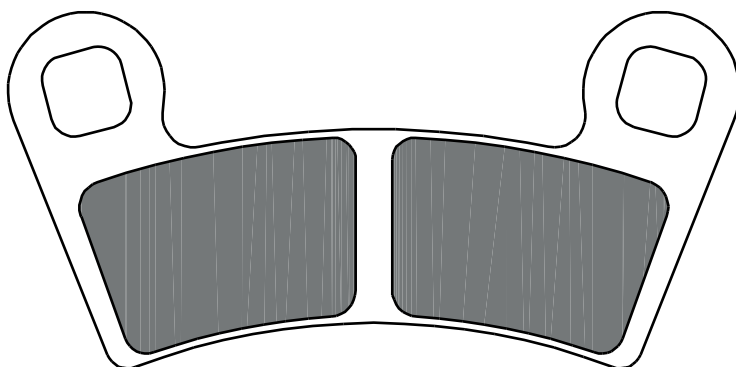

**POLARIS**

450 OUTLAW MXR	09 >	•
450 OUTLAW S	08 >	•

525 OUTLAW	07 >	•
525 OUTLAW IRS	08 >	•
525 OUTLAW S	08 >	•
570 RANGER RZR EFI	12 >	•

800 RANGER RZR EFI	08 >	•
800 RANGER RZR S EFI	09 >	•
800 RZR	08 >	•



**07P010.SD** 120.4 x 57 x 7.6

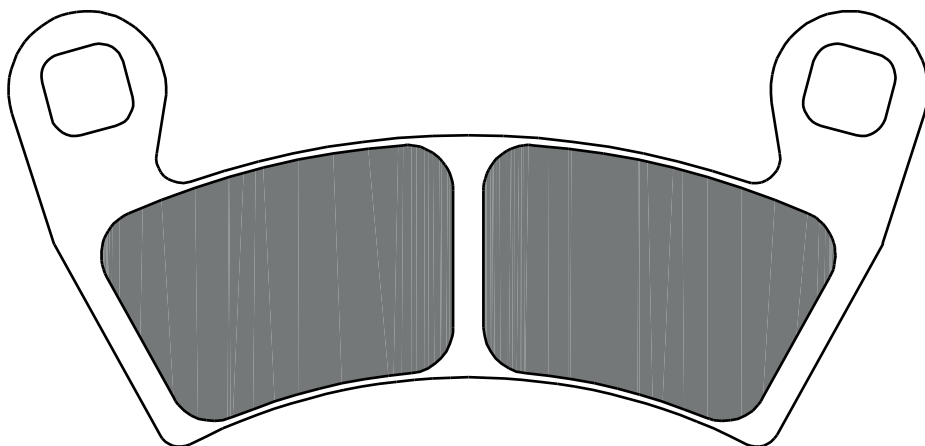

**POL**

700 RANGER 6X6 EFI	12 >	•
--------------------	------	---

700 MVRS 4X4	08 >	• •
700 RANGER 4X4 EFI	08 >	• •
800 EV-LSV	10 >	•
800 LSV 4X4	11 >	•
800 MV DIESEL CREW	13 >	• •
800 MVRS 4X4	08 >	• •
800 RANGER 48V EV	13 >	•
800 RANGER 4X4 EFI	10 >	• •

800 RANGER 6X6 EFI	10 >	• •
800 RANGER CREW	12 >	• •
800 RANGER RZR4 EFI	12 >	•
800 RANGER XP	12 >	•
800 RZR 4	10 >	•
900 RANGER 4X4 DIESEL	10 >	• •
900 RANGER RZR4 XP EFI	12 >	• •
900 RANGER RZR4 XP4 EFI	12 >	• •

**POLARIS**

500 RANGER 2X4	08 >	•
500 RANGER 2X4 EFI	08 >	•
500 RANGER 4X4	12 >	•



**07P011.SD** 96.2 x 43.1 x 7.7

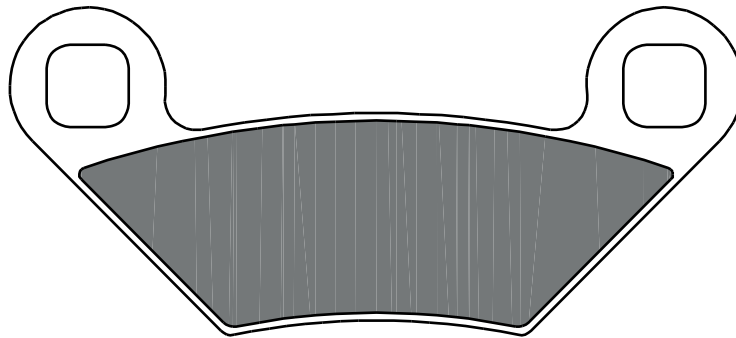

### POLARIS

550	SPORTSMAN	11 >	• •
550	SPORTSMAN EPS	10 >	• •
550	SPORTSMAN EPS X2	14 >	• •
550	SPORTSMAN TOURING EPS	10 >	• •
550	SPORTSMAN X2	10 >	• •
550	SPORTSMAN XP	09 >	• •
550	SPORTSMAN XP EPS	09 >	• •
550	SPORTSMAN XP TOURING EPS	12 >	• •
850	FOREST	15 >	• •
850	SCRAMBLER	15 >	• •

850	SCRAMBLER HO / HO EPS	13 >	• •
850	SCRAMBLER MD	15 >	• •
850	SPORTSMAN	11 >	• •
850	SPORTSMAN MV	12 >	• •
850	SPORTSMAN TOURING	14 >	• •
850	SPORTSMAN TOURING EPS	10 >	• •
850	SPORTSMAN TOURING HO EPS	13 >	• •
850	SPORTSMAN TOURING MD	15 >	• •
850	SPORTSMAN X2	11 >	• •

850	SPORTSMAN XP	09 >	• •
850	SPORTSMAN XP EPS	09 >	• •
850	SPORTSMAN XP HO EPS	13 >	• •
850	SPORTSMAN XP HO EPS MD	15 >	• •
850	SPORTSMAN XP TOURING EPS	15 >	• •
1000	FOREST	15 >	• •
1000	SCRAMBLER MD	15 >	• •
1000	SCRAMBLER XP	15 >	• •
1000	SCRAMBLER XP HO EPS	14 >	• •
1000	SPORTSMAN MD	15 >	• •
1000	SPORTSMAN TOURING	15 >	• •
1000	SPORTSMAN XP	15 >	• •



**07P012.SD** 87 x 42.40 x 7.80

**07P012.SX** “ “ “

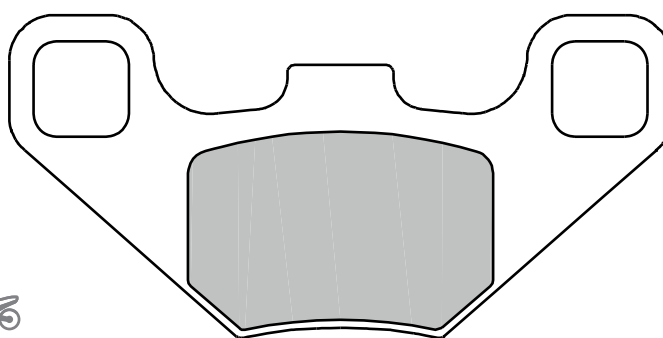
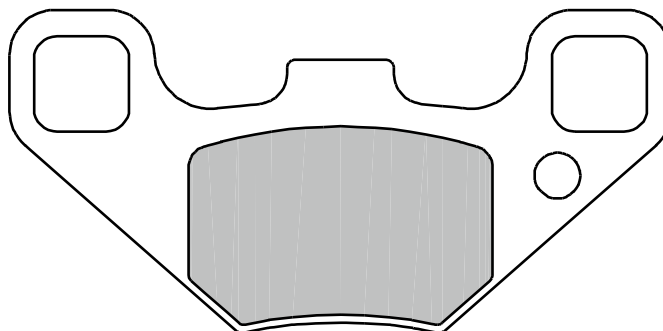

**POLARIS**

170 RANGER RZR	09 >	•
200 PHOENIX	10 >	•



**07P013.SD** 88.70 x 46.70 x 7.20

**07P013.SX** “ “ “

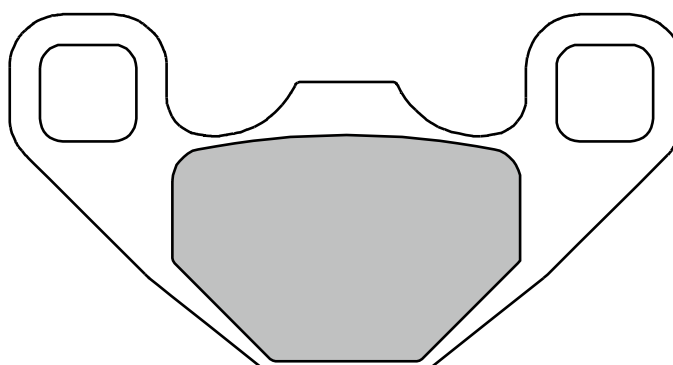

**POLARIS**

170 RANGER RZR	09 >	•
----------------	------	---



**07SU01.25** 50.3 x 50.3 x 12.5  
49.9 x 52.9 x 11

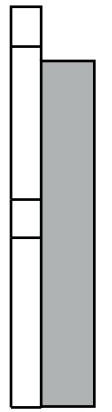
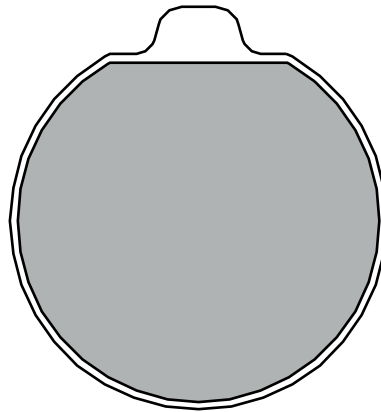
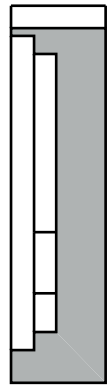
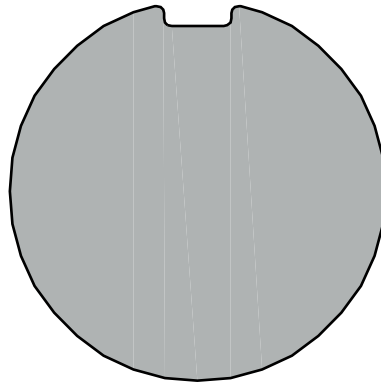

**SUZUKI**

400	GS B,C,	77 > 78	•
425	GS N, EN	79 >	•
750	GS	76 > 77	•
750	GS B, C, EC	77 >	•
750	GS DB, EX, EN	77 >	•
850	GS GN, EN, GT	79 >	•



**07SU02.20** 49.5 x 52.9 x 11.5  
49.7 x 53 x 12.8

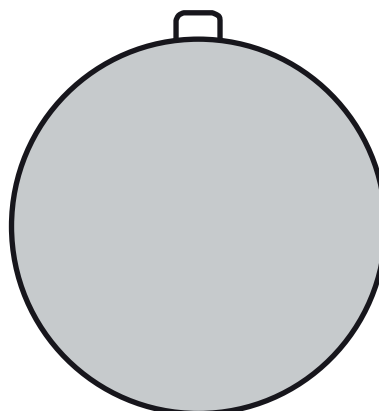
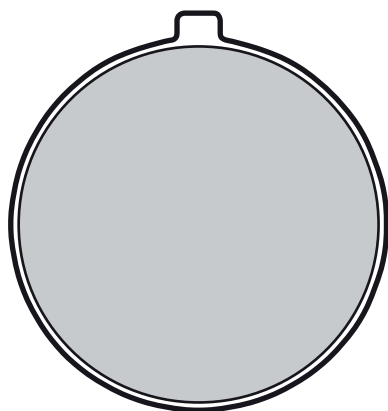

**SUZUKI**

125 GT C, EC, N, E	78 > •	400 GS L	79 > •	550 GS EC	78 > •
125 RG	79 > 91 •	400 GS T	81 > •	550 GS EN, LN	79 > •
250 GT B6, B7, X7	78 > •	425 GS LN	80 > •	550 GT A, B	78 > •
250 RG E	78 > •	500 GT K, L, M	73 > 75 •	750 GS L, N, LN	79 > •
400 GS	78 > •	550 GS B	77 > •	1000 GS N, EN, HN, LN, SN	79 > •
		550 GS DB	77 > 78 •	1000 GS S, HC, EC, EN	78 > •
		550 GS E	78 > 79 •		



**07SU03.12** 75.6 x 49.4 x 11

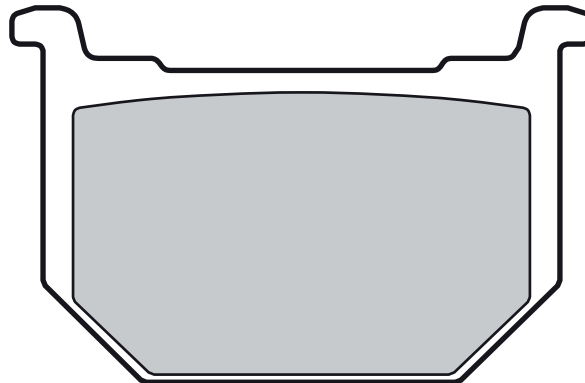

### SUZUKI

250 GN	86 > 92	•	400 GSX F	81 >	•	750 GSX E, EF, ET, EZ, EX, L, LT, LX	80 > 82	•
250 GN	93 >	•	400 GSX FWS, TD, EE	84 >	•	750 GSX ES	83 >	•
250 GNX E	83 >	•	400 GSX S, L	83 >	•	750 GSX KATANA	82 > 85	•
250 GS T, L	81 > 82	•	450 GS E, L, S	80 > 83	•	750 GSX S	82 > 85	•
250 GS TT, TX, TZ	80 > 82	•	450 GSX ET, FT, S	80 > 81	•	850 GS E, G, GT, GX, GLX, L	80 >	•
250 GSX	80 > 81	•	550 GS ET, LT	80 > 81	•	850 GS GD, GLD, TD	83 >	•
250 GSX E, ET	80 > 81	•	650 GS L	81 >	•	850 GS GL, GLT	81 >	•
250 GSX OX, EX, LT, TT	81 > 82	•	700 GV GLG MADURA	86 >	•	850 GS GZ, GLZ	82 >	•
400 GN X, T, TZ, XX	80 >	•	750 GS ED, ESD	83 >	•	850 GSX G	83 >	•
400 GSX E	86 >	•	750 GS ET, LT, T	80 >	•	1000 GS G, GLT, LT	80 >	•
400 GSX ET, X, ST, SX	80 >	•	750 GS EX, LX, X	81 >	•	1200 GV GLG MADURA	86 >	•
			750 GSX E	82 > 83	•			



**07SU04.12** 71.9 x 44.8 x 11

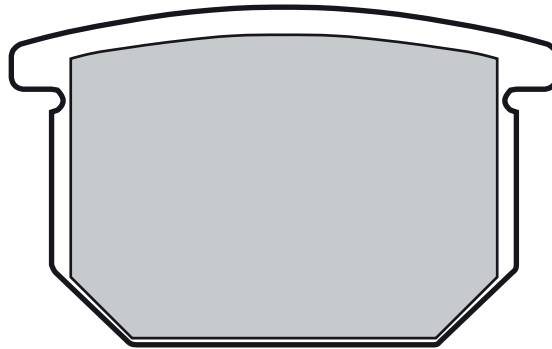

### SUZUKI

250 GSX S	86 > •	650 GS GD,G, MD,KATANA	83 > •	1000 GSX S, KATANA	82 > •
400 GSX FWS	86 > •	650 GS GT	81 > •	GS ED, ESD, GD, GKD, GLD, SD	83 > •
450 GS GA, L	86 > •	650 GS TURBO, XN	83 > •	1100 GS ET, L, LT, ST, T	79 > 80 •
450 GS L	85 > •	650 GSX GT	85 > 85 •	1100 GS EX, LX, TX, X	81 > •
500 GS M	81 > •	650 LS P	87 > •	1100 GS G	86 > •
500 GS MX	81 > •	680 RG	86 > 87 •	GS GD, GKZ, GLD, GLZ, GZ	82 > 83 •
550 GS E, L, T, LX, LT, TX	80 > •	750 GS KATANA	85 > •	1100 GSX E, L	79 > •
550 GS EM	81 > 84 •	750 GS SD	83 > •	1100 GSX E, S	82 > •
550 GS LZ, MZ	82 > •	750 GS SZ	82 > •	1100 GSX ES	82 > •
550 GS ME, KATANA	81 > •	750 GSX ES, EF, STS	86 > •	1100 GSX ET	79 > •
650 GR	83 > •	750 GSX KATANA	86 > •	1100 GSX Z, ESD	86 > •
650 GR D, XD	83 > 86 •	750 GSX S	86 > •	1100 GT ET, T, LT, ST	80 > •
650 GR E	83 > •	850 XN TURBO	82 > •	1400 GV CAVALCADE	85 > •
650 GS EX, GLX, X, GX	81 > •	1000 G SZ	82 > •		
650 GS EZ, GZ, GLZ	82 > •	1000 GS EX	81 > •		
		1000 GSX E, EZ, GKZ, S, SZ, X, KATANA	82 > •		





**07SU05.26** 43.5 x 46.3 x 13  
43.4 x 46.8 x 11.5

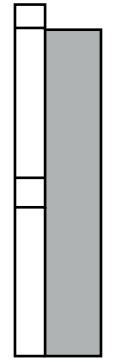
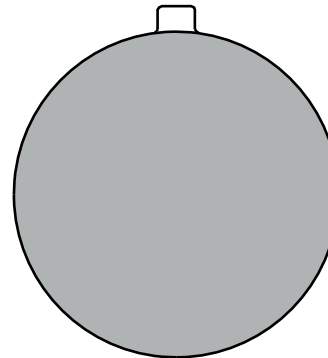
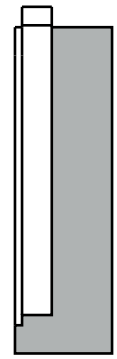
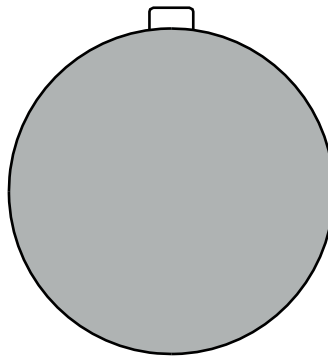

**SUZUKI**

100 GP C	78 > 81	•
125 GP	78 >	•



**07SU06.07** 57.9 x 53.4 x 8.7  
**07SU06.SA** " " "  
**07SU06.SP** " " "

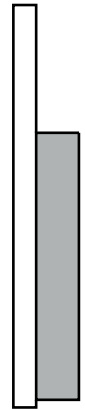
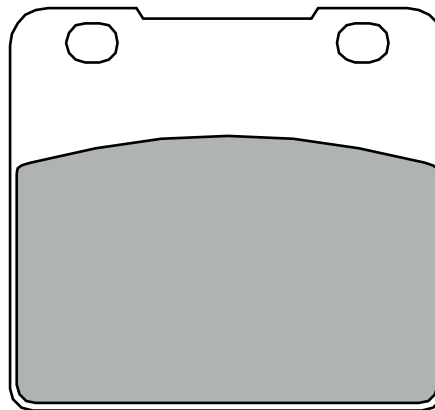

**SUZUKI**

250 GSX-R	88 >	•
400 GSX X	86 >	•
400 GSX-R	87 > 87	•
400 VS GL INTRUDER	95 >	•
500 RG GAMMA	85 > 89	•
500 RG RF	85 >	•
600 GL	96 >	•

600 VS GL INTRUDER	95 >	•
650 GSX GT	86 >	• •
700 VS GLFG	86 >	•
750 GS RF	85 >	•
750 GSX-R	85 > 87	•
750 VS INTRUDER	86 > 91	•
800 VS N, INTRUDER	91 > 96	•
1100 GSX EFE	85 >	• •

1100 GSX F	88 > 95	•
1100 GSX R	86 > 89	•
1150 GS EG	86 >	• •
1150 GS ES	84 >	• •
1400 GL CAVALCADE	87 >	•
1400 GVS CAVALCADE LXE	87 >	• •
1400 VS INTRUDER	87 > 04	• •
1500 VL INTRUDER	98 > 01	• •



**07SU07.07** 57.9 x 47.3 x 8.7

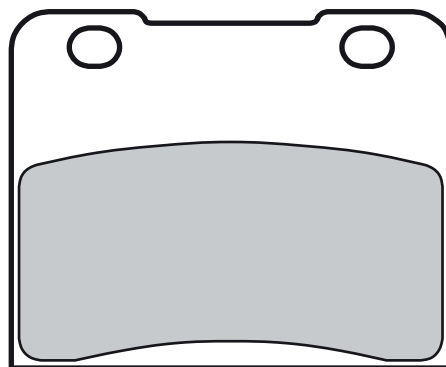

**SUZUKI**

250	GF S	88 >	•
250	RG GAMMA	85 > 87	•
400	GSX-R F	85 >	•



**07SU08.08** 76.8 x 53.8 x 9.5

**07SU08.TT** “ “ “

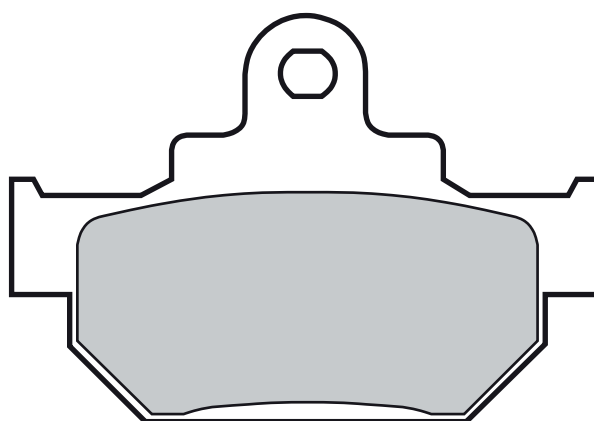

**SUZUKI**

125	RM G	86 >	•
250	RM G	86 >	•
500	DR	89 >	•
600	DR R, DAKAR	86 >	•
600	DR S	85 > 86	•
600	SP F	85 > 87	•



**07SU09.04** 76.8 x 53.8 x 7.1

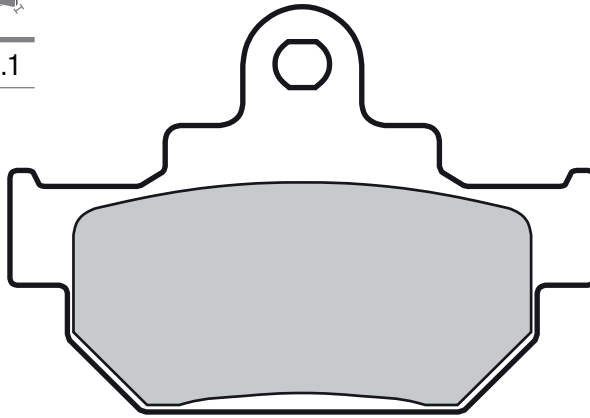

**MAICO**

250	CR	87 > 88	• •
250	GM STAR	86 >	• •
250	GP	87 > 88	• •
400	CR	87 > 88	• •
400	GP	87 > 88	• •
500	CR	86 >	• •
500	GP	86 >	• •
500	GP	87 > 88	• •
550	GP	87 >	• •

**SUZUKI**

125	INTRUDER	00 >	•
125	MARAUDER	00 >	•
125	RM	85 > 90	•
125	VL INTRUDER	02 >	•
250	INTRUDER	00 >	•
250	MARAUDER	00 >	•
250	RM	85 > 88	•
250	TU X SUPER CLASSIC	97 >	•
250	VL INTRUDER	00 >	•

400	LS SAVAGE	87 >	•
500	RM	85 > 86	•
650	LS	86 >	•
650	LS P SAVAGE	95 > 98	•



**07SU10.05** 52.4 x 43.9 x 7.2

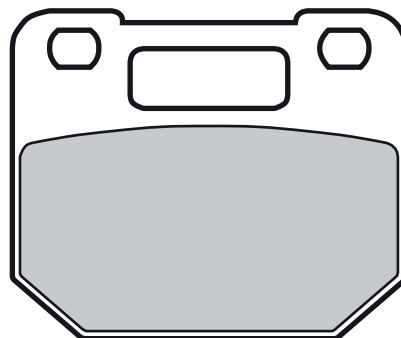

**SUZUKI**

80	RG GAMMA	88 > 93	•
125	RG GAMMA	85 > 89	•



**07SU11.21** 84.9 x 34.9 x 8

55.8 x 37 x 10.2

**07SU11.SD** “ “ “

**07SU11.SX** “ “ “

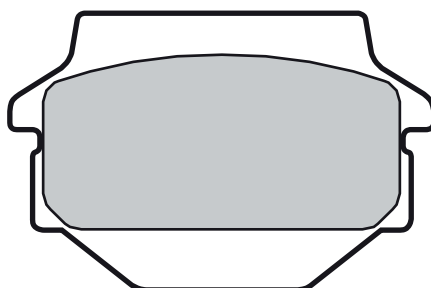
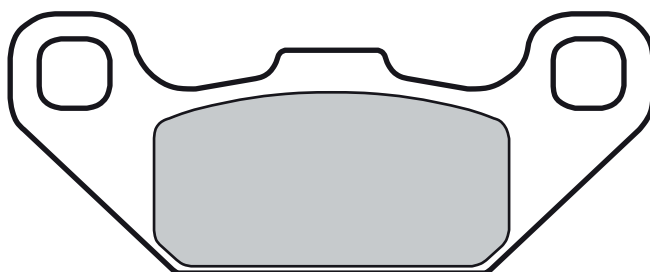

### KAWASAKI

250	KSF A1-A17 MOJAVE	87 >	•
250	KXF A1, A2 TECATE	87 > 88	•
250	KXT B2 TECATE	87 >	•
300	KEF LAKOTA	95 >	•



### SUZUKI

230	LT EH-EP	86 > 93	•
230	LT SF-SJ	85 > 88	•
230	LT SG	86 >	•
250	LT RF-RH	85 > 87	•



250	LT RJ-RR	88 > 94	•
250	LT SK, SL	89 > 90	•
500	LT RH, RR	87 > 95	•



<b>07SU12.15</b>	76.9 x 41.9 x 8		
	96.6 x 41.9 x 8		
<b>07SU12.SP</b>	“ “ “		
<b>07SU12.SD</b>	“ “ “		
<b>07SU12.SX</b>	“ “ “		

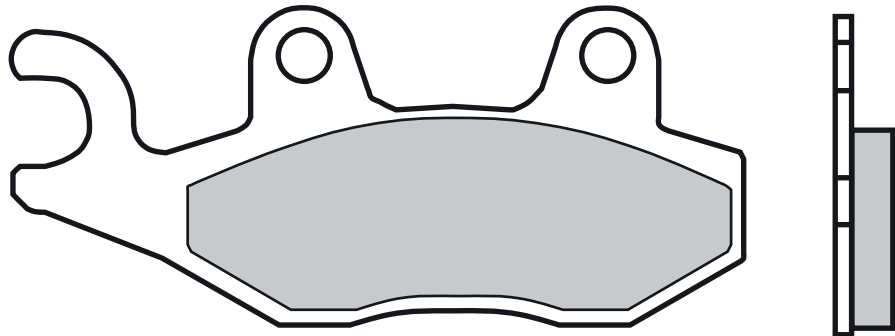
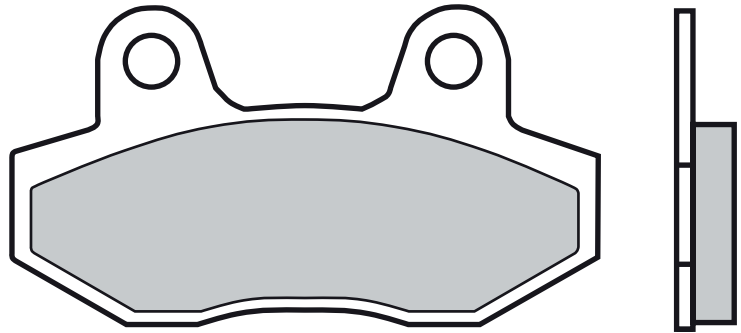

### HONDA

125 CA REBEL	95 > 96	•
150 NSR	02 >	•
250 CMX REBEL	96 > 96	•

### HUSQVARNA

125 CR	92 > 94	•
125 WR	92 > 94	•
250 CR	92 > 94	•
250 WR	92 > 94	•
350 TE	92 > 94	•

### HYOSUNG

125 AQUILA	00 > 01	•
------------	---------	---

### KAWASAKI

125 KLX	10 >	•
125 KLX D-TRACKER	10 >	•
125 KX	89 > 93	•
200 KDX	93 > 93	•
250 KDX D, SR	91 > 94	•
250 KLX 250	09 >	•
250 KLX S, SF	09 >	•
250 KX	89 > 93	•
252 EL	01 >	•
500 KX	89 > 93	•
750 KRF TERYX 4X4 LEFT	08 >	•

### SUZUKI

125 EN	05 >	•
125 RM	91 > 95	•
125 RM H	87 > 88	•
125 RM X	89 > 90	•
125 TS R	89 >	•
200 TS R	90 >	•
250 DR S	90 > 95	•
250 LT SF QUADRACER	85 >	•
250 RM	89 > 90	•
250 RM	91 > 95	•
250 RM H	87 > 88	•
250 RMX L	89 > 95	•
350 DR SH, S, SL, SM	90 > 98	•
350 DR, S	92 >	•
500 RM H	87 >	•

### TRIUMPH

800 AMERICA	03 > 06	•
800 BONNEVILLE	01 > 04	•
800 BONNEVILLE AMERICA	02 >	•
800 BONNEVILLE BLACK	04 >	•
800 BONNEVILLE T100 PAUL SMITH	06 > 08	•
800 SPEEDMASTER	03 > 04	•
865 BONNEVILLE SE	09 >	•
865 BONNEVILLE T100	09 >	•
865 NEW BONNEVILLE	09 >	•
865 SPEEDMASTER	05 >	•

900 AMERICA	07 >	•
900 BONNEVILLE	09 >	•
900 BONNEVILLE T100	09 >	•
900 BONNEVILLE T100	16 >	•
900 SCRAMBLER	06 >	•
900 STREET TWIN	16 >	•
900 THRUXTON	04 >	•
950 DAYTONA T595	96 > 98	•
955 DAYTONA	99 >	•
955 DAYTONA CENTENNIAL	02 >	•
955 DAYTONA T955I	06 >	•
955 SPEED TRIPLE	99 > 04	•
955 SPRINT RS	00 >	•
1050 SPEED TRIPLE	05 > 07	•
1050 SPEED TRIPLE	08 > 13	•
1050 SPEED TRIPLE (SPECIAL EDITION)	09 >	•
1050 SPEED TRIPLE ABS	11 > 12	•
1050 SPEED TRIPLE R	12 >	•
1050 SPEED TRIPLE R ABS	12 >	•
1050 SPEED TRIPLE S	05 > 07	•
1050 SPEED TRIPLE S	16 >	•
1050 SPEED TRIPLE S ABS	08 > 08	•
1050 SPRINT GT ABS	11 >	•
1050 SPRINT ST	05 >	•
1200 BONNEVILLE T120 BLACK	16 >	•
1200 THRUXTON	16 >	•
1200 THRUXTON R	16 >	•

**YAMAHA**

50 FZR	92 > •
80 YD	89 > •
125 WR	91 > 97 •
125 XT Z	05 > 06 •
125 YZ	89 > 89 •
125 YZ	90 > 95 •
125 YZ	96 > 97 •

200 DT WR
200 WR
250 TT R
250 WR
250 WR
250 WR
250 YZ
250 YZ
250 YZ

91 > •
91 > 94 •
93 > •
90 > 90 •
91 > 91 •
92 > 97 •
89 > 89 •
90 > 91 •
91 > 97 •

350 TT	95 > •
360 YZ	89 > •
450 YXR RHINO	06 > •
450 YZF S	04 > 05 •
500 WR	91 > 91 •
500 WR	92 > 93 •
660 RHINO left caliper	05 > •
700 YXR RHINO RIGHT/REAR	08 > • •



<b>07SU13.06</b>	58.9 x 57.8 x 8
------------------	-----------------

<b>07SU13.SA</b>	“ “ “
------------------	-------

<b>07SU13.SP</b>	“ “ “
------------------	-------

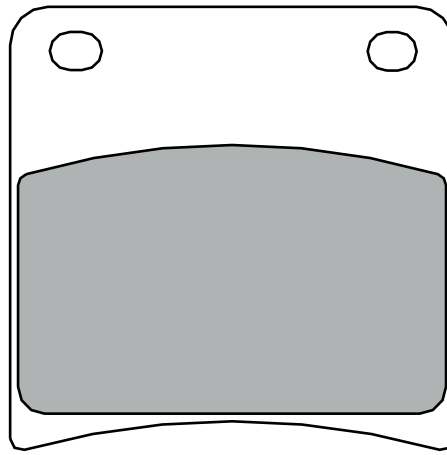

### SUZUKI

400 GSX F	89 >	•
600 GSX F	88 > 97	•
750 GSX F	89 > 95	•
750 GSX KATANA	89 > 95	•
800 VX	90 > 93	•
1100 GSX F	88 > 95	•
1400 GL CAVALCADE	87 >	•



**07SU14.07** 69.8 x 55 x 8.5

**07SU14.SA** “ “ “

**07SU14.SC** “ “ “

**07SU14.RC** “ “ “

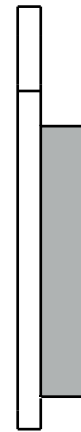
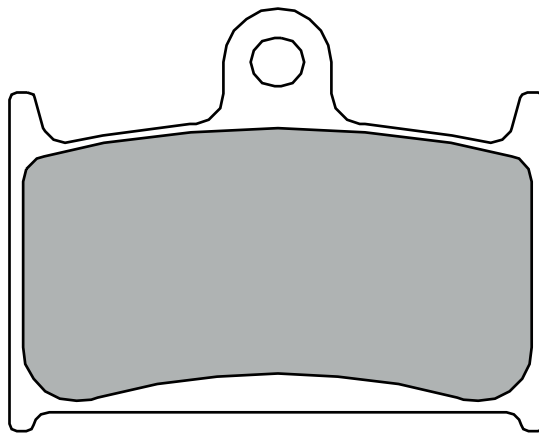

### INDIAN

1800 CHIEF CLASSIC	14 >	•
1800 CHIEF VINTAGE	14 >	•
1800 CHIEFTAIN	14 >	•

### MZ

1000 MUZ S	03 >	•
1000 MUZ SF	05 >	•
1000 MUZ SFX	07 >	•
1000 MUZ SN	05 >	•
1000 MUZ ST	07 >	•

### PGO

125 KUNG FU	70 >	•
-------------	------	---

### SUZUKI

250 RG GAMMA	88 >	•
400 GSX-R, RR	90 >	•
600 GSX-R	93 > 96	•
750 GSX-R	88 > 93	•

1100 GSX KATANA, F	93 >	•
1100 GSX R	89 > 92	•
1200 GSF BANDIT	95 > 96	•

### TRIUMPH

600 DAYTONA	04 >	•
600 SPEED FOUR	03 >	•
600 TT	00 > 03	•
650 DAYTONA	05 >	•
750 DAYTONA	91 > 92	•
800 TIGER EXPLORER	12 >	•
865 SPEEDMASTER	05 >	•
900 DAYTONA	91 > 94	•
900 DAYTONA SPEED TRIPLE	94 >	•
900 DAYTONA SPRINT	94 >	•
900 SPEED TRIPLE	94 > 96	•
900 SPEED TRIPLE	97 > 01	•
900 TROPHY	96 >	•
950 DAYTONA T595	96 > 98	•
955 DAYTONA	99 >	•

955 DAYTONA CENTENNIAL	02 >	•
955 DAYTONA T955I	06 >	•
955 SPEED TRIPLE	99 > 04	•
955 SPRINT RS	00 >	•
955 SPRINT ST	99 > 04	•
1000 DAYTONA	91 > 95	•
1050 SPRINT GT ABS	11 >	•
1050 SPRINT ST	05 >	•
1200 DAYTONA	91 >	•
1200 TIGER EXPLORER	12 >	•
1200 TROPHY	96 >	•
1500 THUNDERBIRD	09 >	•
1600 THUNDERBIRD	09 >	•
1700 THUNDERBIRD STORM	11 >	•
2300 ROCKET III	04 >	•
2300 ROCKET III CLASSIC	07 >	•
2300 ROCKET III ROADSTER	11 >	•
2300 ROCKET X	15 >	•

### YAMAHA

250 TZ GP	90 > 02	•
750 FZR R OW 01	89 >	•





<b>07SU15.09</b>	116.9 x 47.9 x 9
	97.4 x 57.9 x 11

<b>07SU15.SA</b>	“	“	“
------------------	---	---	---

<b>07SU15.TT</b>	“	“	“
------------------	---	---	---

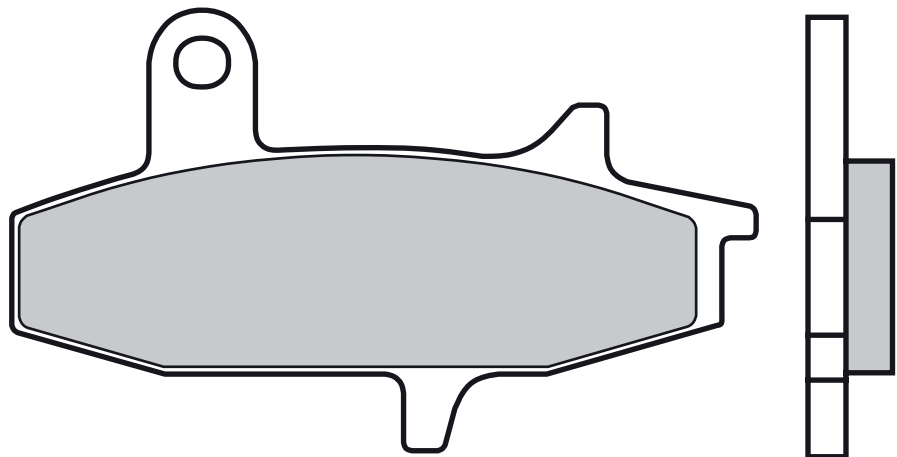
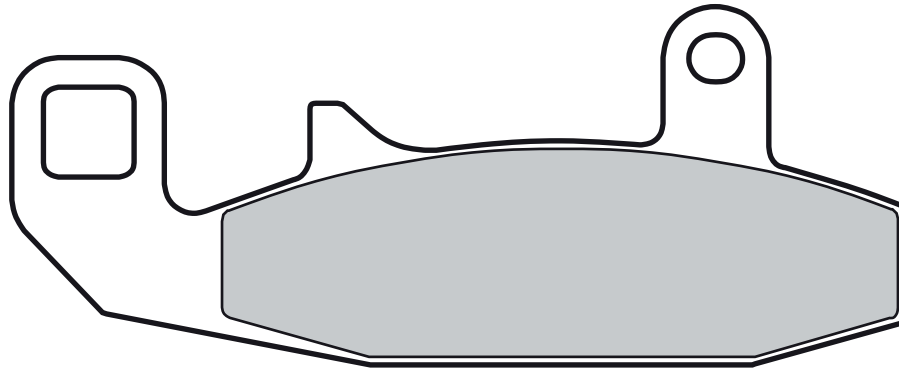

**SUZUKI**

600 DR RK, DJEBEL	89 >	•
650 DR R-RS	90 > 95	•
650 DR RSE	90 > 95	•

650 VS	91 >	•
750 DR BIG	88 >	•
750 DR BIG	89 >	•
750 DR S	88 >	•

800 DR BIG	90 > 90	•
800 DR S	90 > 90	•
800 DR Z	88 > 90	•
800 DR Z	91 >	•



**07SU16.CC** 133.50 x 37.40 x 9.80  
109.20 x 44.50 x 9.80

**07SU16.SP** “ “ “

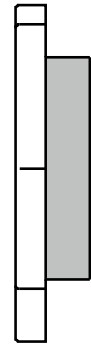
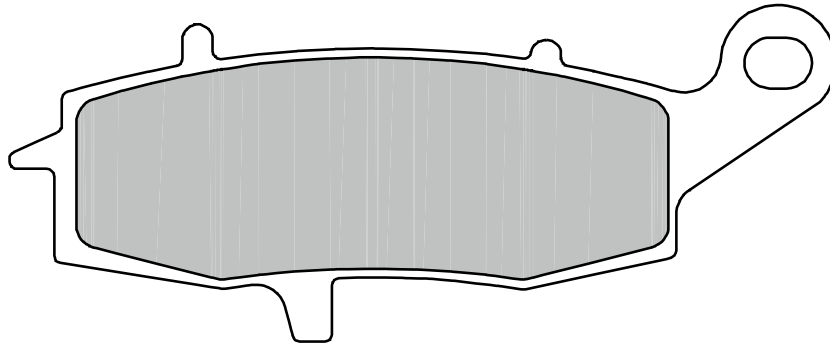
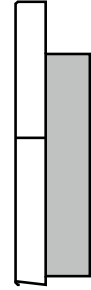
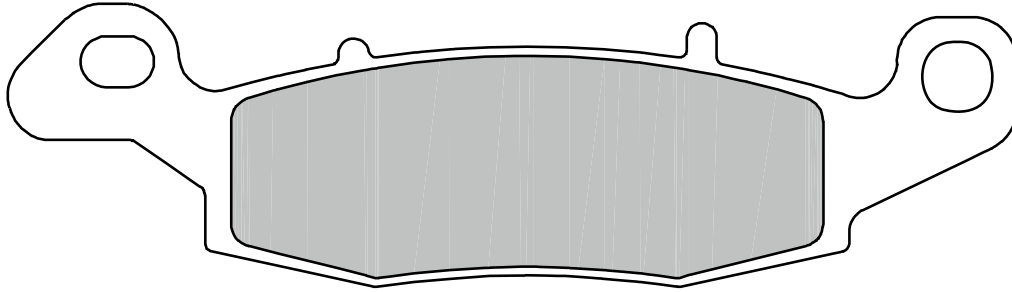

**SUZUKI**

1800 C R INTRUDER	08 >	•
1800 M R INTRUDER	06 >	•
1800 M R2 INTRUDER	08 >	•



**07SU17.18** 99.2 x 44.1 x 7.4  
83.2 x 47.8 x 9.8

**07SU17.SP** “ “ “

**07SU17.TT** “ “ “

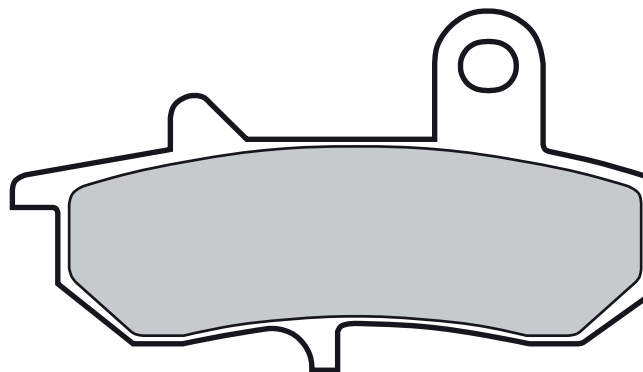
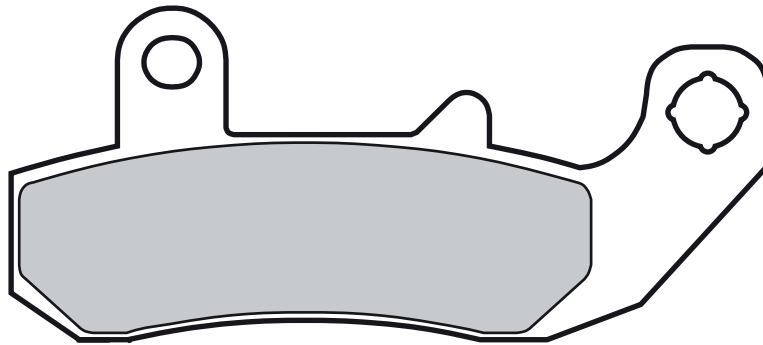

### SUZUKI

125 RG	92 >	•
125 RG F	92 >	•
125 RG GAMMA	92 >	•
125 RG WOLF	92 >	•
200 RG GAMMA	91 >	•
200 WOLF	92 >	•

250 RGV GAMMA	93 >	•
600 DR RK, DJEBEL	89 >	•
650 DR R-RS	90 > 95	•
650 DR RSE	90 > 95	•
650 VS	91 >	•
750 DR BIG	89 >	•
800 DR BIG	90 > 90	•

800 DR S	90 > 90	•
800 DR Z	91 >	•

### YAMAHA

125 DT TENERE SCOUT	90 >	•
125 DTZ TENERE	90 >	•



<b>07SU18.SD</b>	62 x 40.7 x 9.5
<b>07SU18.TT</b>	“ “ “

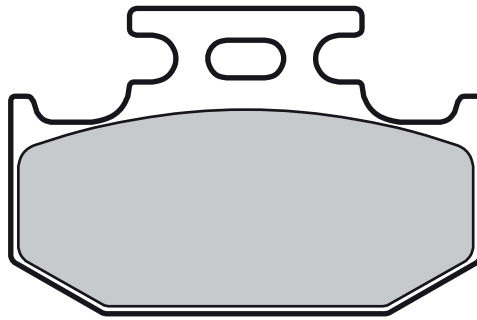

### SUZUKI

125 RM	91 > 95	•
250 RMX L	89 > 95	•
250 RMX T	96 > 98	•
350 DR SH, S, SL, SM	90 > 98	•

350 DR V, M, X	97 >	•
650 DR SE T-W	96 > 98	•

### YAMAHA

125 YZ	96 > 97	•
250 YZ	91 > 97	•
400 WR F	98 > 98	•
400 YZ F	98 > 98	•



<b>07SU19.07</b>	89.7 x 52.2 x 8
<b>07SU19.SA</b>	“ “ “
<b>07SU19.SC</b>	89.7 x 52.2 x 9.5
<b>07SU19.RC</b>	“ “ “

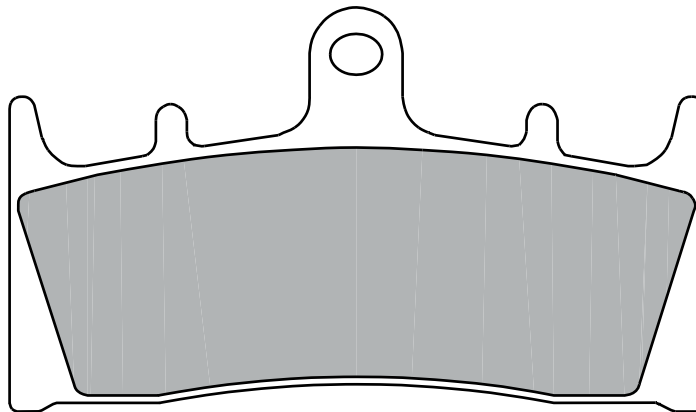

### KAWASAKI

600 ZX-6R	98 > 02	•
636 ZX-6RR	02 >	•
750 ZX 7 R	96 >	•
900 ZX 9R	96 > 97	•
900 ZX 9R	99 > 01	•
1100 ZRX	96 > 00	•
1200 ZRX, R, S	01 >	•

1200 ZX12R NINJA	00 >	•
1500 VN	02 >	•
1500 VN MEAN STREAK	02 > 03	•
1600 VN	04 >	•
1600 VN MEAN STREAK	04 >	•

### SUZUKI

750 GSX-R	94 > 99	•
-----------	---------	---

1000 GSX	01 >	•
1000 GSX R	01 > 02	•
1000 TL R	98 >	•
1100 GSX R	93 >	•
1200 GSF BANDIT	01 >	•
1200 GSF BANDIT S	01 >	•
1300 GSX R HAYABUSA	99 > 07	•
1400 GSX	02 >	•
1600 VZ MARAUDER	04 >	•



<b>07SU20.07</b>	52.5 x 56.3 x 8.7
<b>07SU20.SP</b>	“ “ “

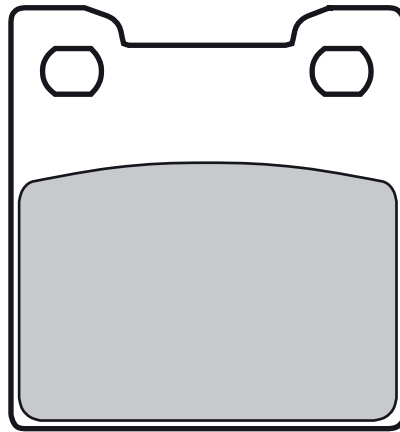

**SUZUKI**

900 RF RR	94 > 96	•
-----------	---------	---



<b>07SU22.SA</b>	69.8 x 55 x 7
------------------	---------------

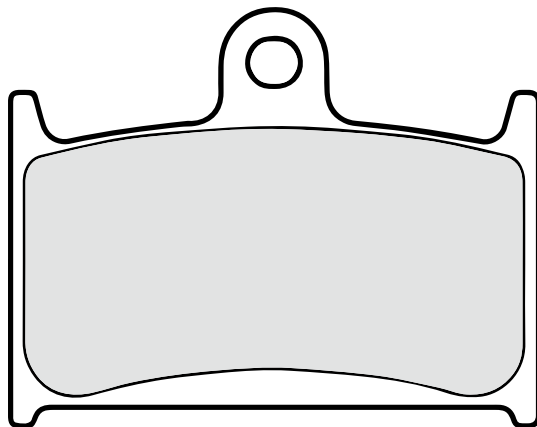

**SUZUKI**

900 RF RR	94 > 96	•
1200 GSF BANDIT	97 > 00	•



**07SU25.SP** 59.7 x 57.1 x 9

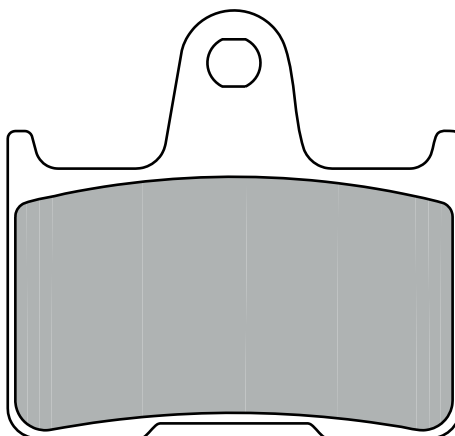

**SUZUKI**

600 GSX-R	04 > 05	•
650 GSF BANDIT	05 >	•

650 GSF BANDIT S	05 >	•
750 GSX-R	04 > 05	•
1000 GSX R	01 > 02	•
1000 GSX R	12 >	•

1000 GSX R K3	03 > 03	•
1000 GSX R K4	04 > 06	•
1400 GSX	02 >	•



**07SU26.SA** 38.7 x 49.2 x 7.9

**07SU26.SC** 38.7 x 49.2 x 9.5

**07SU26.RC** “ “ “

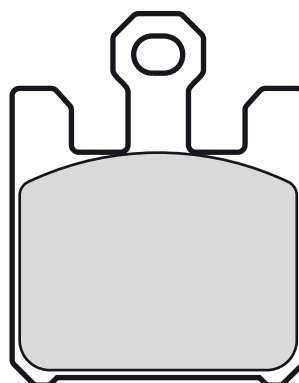

**KAWASAKI**

600 ZX-6R	03 > 04	•
600 ZX-6RR	05 > 06	•
636 ZX-6R	05 > 06	•
636 ZX-6RR	03 > 04	•

750 Z R	11 >	•
1000 ZX 10 R	04 > 07	•
1200 ZX12R NINJA	04 >	•
1600 VN CLASSIC TOURER	05 >	•
1600 VN MEAN STREAK	05 >	•

**SUZUKI**

1000 GSX R K3	03 > 03	•
1600 M INTRUDER	05 >	•
1600 M95 BOULEVARD	05 >	•
1800 VRZ INTRUDER	06 >	•



<b>07SU27.SA</b>	71.1 x 49.6 x 8
<b>07SU27.SC</b>	71.1 x 49.6 x 9
<b>07SU27.RC</b>	“ “ “

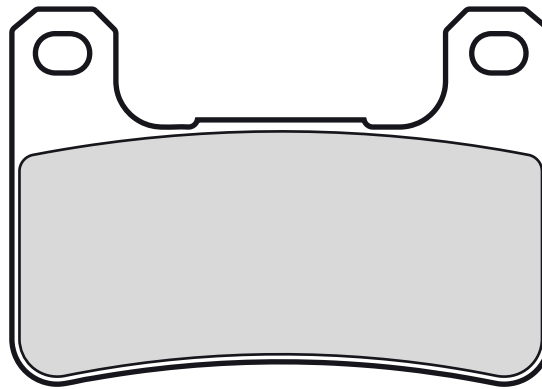

### KAWASAKI

1000 Z	10 >	•
1000 Z SX	11 >	•
1000 Z SX ABS	11 >	•
1000 Z1000 SUGOMI EDITION	16 >	•
1000 ZX 10 R	08 > 10	•
1000 ZX 10 R	11 > 15	•
1000 ZX 10 R (ABS)	08 > 10	•
1000 ZX 10 R (ABS)	11 > 15	•



### SUZUKI

600 GSX-R	04 > 05	•
600 GSX-R	06 > 10	•
750 GSX-R	04 > 05	•
750 GSX-R	06 > 10	•
1000 DL V STROM	14 >	•
1000 DL V STROM ABS	14 >	•
1000 GSX R	09 > 11	•
1000 GSX R K4	04 > 06	•



1000 GSX R K7	07 > 08	•
1300 GSX R HAYABUSA	08 > 12	•
1800 M R INTRUDER	06 >	•
1800 M R2 INTRUDER	08 >	•



<b>07SU29.06</b>	47.1 x 45.1 x 7.4
<b>07SU29.SD</b>	“ “ “
<b>07SU29.SX</b>	“ “ “

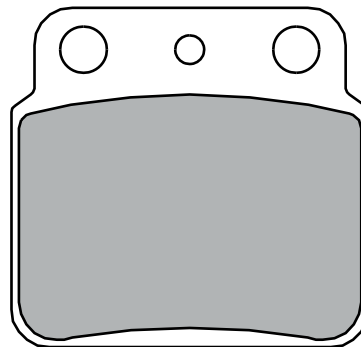

### ARCTIC CAT

400 DVX	04 >	•
---------	------	---



### HYOSUNG

400 TE	05 >	•
450 TE	07 >	•



### SUZUKI

250 LT RJ-RR	88 > 94	•
400 LT-Z QUAD SPORT	02 >	•
450 LT-R	06 >	•
500 LT RH, RR	87 > 95	•

### KAWASAKI

400 KFX	02 >	•
---------	------	---



**07SU30.02** 69.5 x 46.2 x 13  
**07SU30.SP** “ “ “

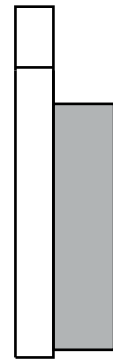
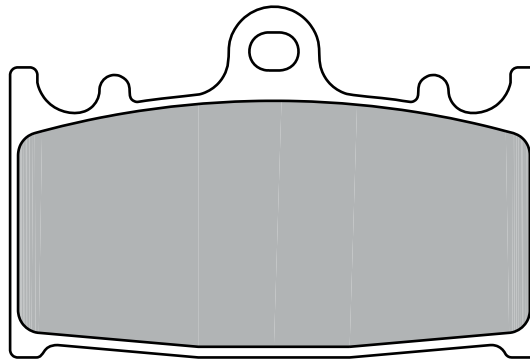

**SUZUKI**

1500 C INTRUDER (LET CALIPER)	05 >	•
1500 VL INTRUDER	02 >	•



**07SU31.SD** 99.2 x 39.7 x 7.6  
 75.4 x 40.7 x 8.4

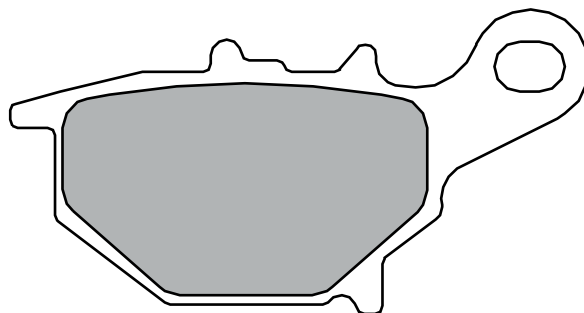
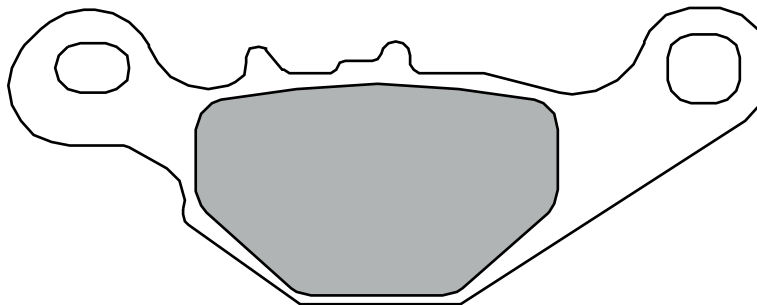

**SUZUKI**

85 RM	05 >	•
-------	------	---





**07SU32.SP** 88.9 x 40.1 x 9.7

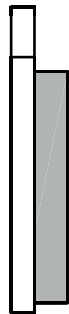
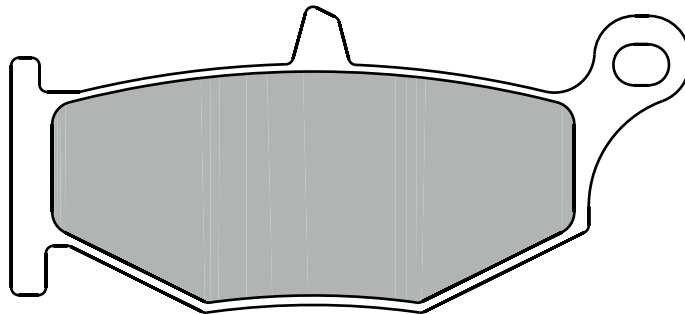
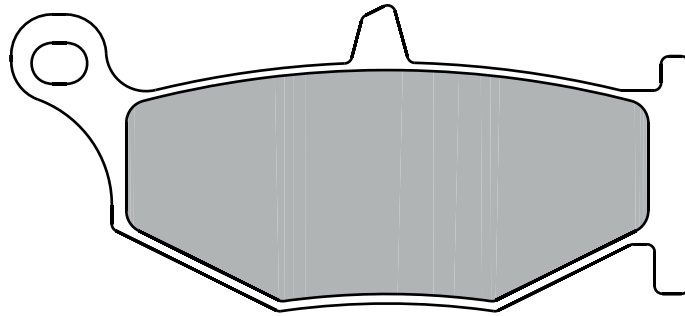

**SUZUKI**

600 GSR	06 >	•
600 GSX-R	06 > 10	•

750 GSX-R	06 > 10	•
1000 DL V STROM	14 >	•
1000 DL V STROM ABS	14 >	•
1000 GSX R K7	07 > 08	•

1300 GSX R HAYABUSA	08 > 12	•
1300 GSX R HAYABUSA (RED CALL)	13 >	•
1340 B-KING	08 >	•



**07YA01.13** 44.9 x 50.8 x 15.5  
44.9 x 44.9 x 12

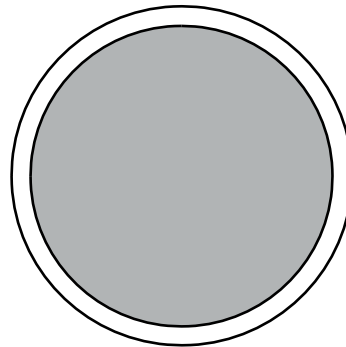
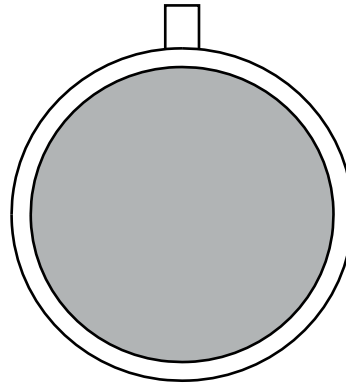

### YAMAHA

90	RD	76 >	•
100	RD D	76 > 79	•
100	RX	76 > 79	•
100	RX DX	77 > 79	•
125	RD B, C	76 > 77	•
125	RD DX	76 > 78	•
125	RS DX	76 > 79	•
200	RD DX	76 > 78	•



**07YA02.07** 47.9 x 68.2 x 9

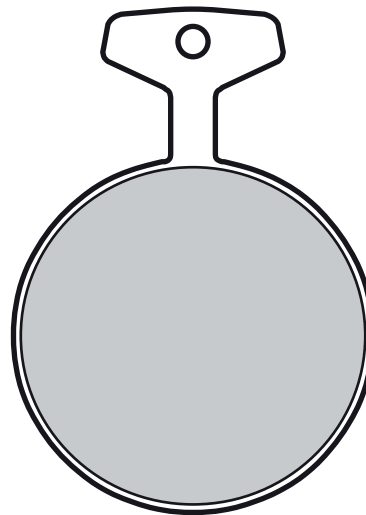

### YAMAHA

250	RD B, S	73 > 77	•	250	TZ	82 >	•	400	RD S	73 > 76	•
250	RD C	77 > 78	• •	350	RD	73 >	•	650	TX	72 >	•
				350	XS B	76 >	•	650	XS B, C, XS2	75 > 77	•
				400	RD C, D, E	77 >	• •	750	TX A	73 > 76	•



**07YA03.09** 66.8 x 49.4 x 11

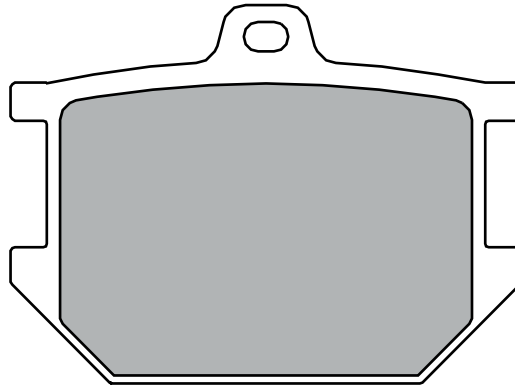

### YAMAHA

250	XS C	77 >	• •
250	XS D, E	79 >	•
350	XS C, D	77 >	• •
400	RD	79 >	•
400	RD F, G	79 > 80	•
400	SR 2J4	77 >	• •
400	XS C, E, F	77 > 79	• •
500	SR	85 >	•
500	SR E, F, G, H	78 > 79	•
500	XS C, D, E	77 >	• •
650	XJ	80 >	•
650	XJ RJ	82 >	• •
650	XS D1E, F, F2	77 > 79	•

650	XS SE, SP	78 > 80	• •
650	XS SJ, SK	82 >	• •
650	XS SK,HERITAGE	83 >	• •
650	XS SPECIAL	79 >	• •
700	FZ	87 >	•
750	XJ E	81 >	•
750	XS D, E, F	77 > 79	• •
750	XS SE	78 >	• •
750	XS SE, SG, LH	80 > 81	•
850	XS	81 >	•
850	XS G, H	80 >	• •
850	XS LG, SG	80 > 81	• •
850	XS SG, SH, LG, LH LEFT CALIPER	81 >	•

850	XS SG, SH, LG, LH right caliper	81 >	•
920	XV RH, RJ	81 > 82	•
920	XV TR1	81 >	•
1000	TR 1	81 >	•
1000	XV	81 >	•
1000	XV TR1	81 > 85	•
1100	XS S, SP	81 >	•
1100	XS SG, SH, LG left caliper	81 >	•
1100	XS SG, SH, LG right caliper	81 >	•



**07YA04.13** 94.4 x 56.9 x 7.50/12

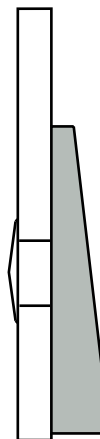
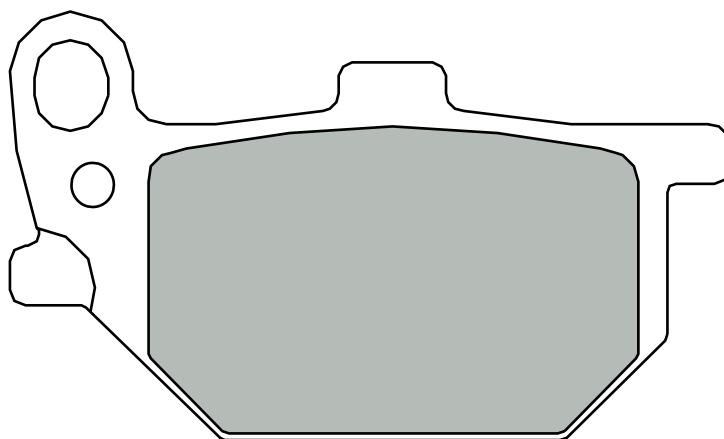
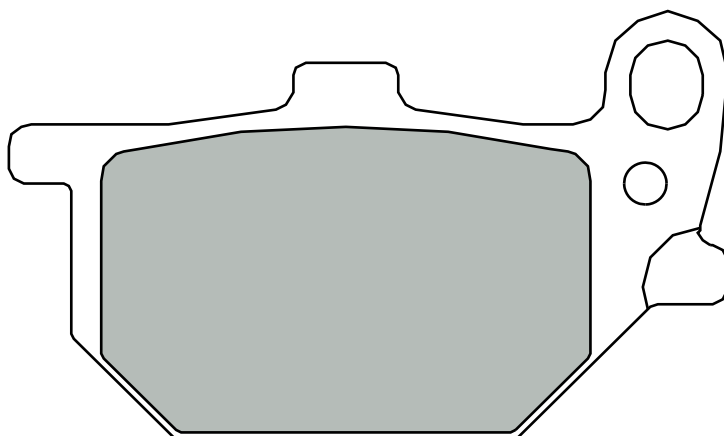

**SUZUKI**

250 RD E, F	78 > 79	•
400 RD	79 >	•

**YAMAHA**

250 RD DX left caliper	80 >	•
250 RD E	78 >	• •

250 XS SE, SF	80 >	•
400 RD D, E, F	78 >	• •
400 RD F, G	79 > 80	•
400 XS SE	80 > 81	•
400 XS SG, SH, SF	80 >	•
650 XJ 4H7	80 >	•
650 XJ G, H, SH right caliper	80 >	•
750 XS SE, SG, LH	80 > 81	•

750 XV MK	83 >	•
850 XS SG, SH, LG, LH right caliper	81 >	•
1100 XJ J	82 >	•
1100 XJ LH	81 >	•
1100 XS SG, SH, LG left caliper	81 >	•



0821 000 555



0821 000 777



DOM TOM



+33 3 89 70 3000



+33 3 89 70 30 99



**07YA05.27** 41.9/44.20 x 44 x 16  
41.9/44.20 x 44 x 10

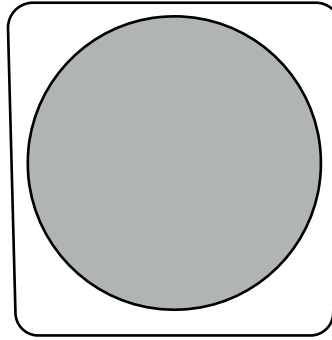
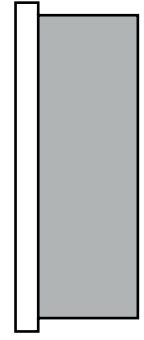
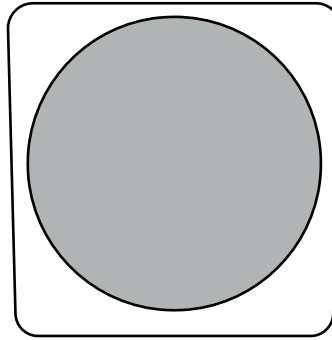

**YAMAHA**

50	RD M	78 > 80	•
100	RX DX	80 > 82	•
125	RD DX/S	78 >	•
125	RS	82 > 86	•
125	RS DX	80 >	•
200	RD DX	78 >	•



**07YA06.09** 65.9 x 58.9 x 10

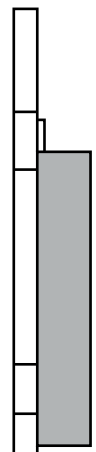
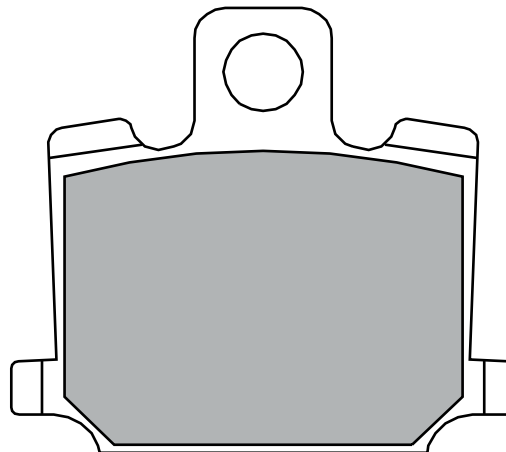

**YAMAHA**

250	RD LC	80 > 80	•
350	RD LC	80 > 80	•
400	XJ	80 > 81	•
1100	XS SP	80 >	•



**07YA07.13** 94.4 x 56.9 x 7.50/12.00

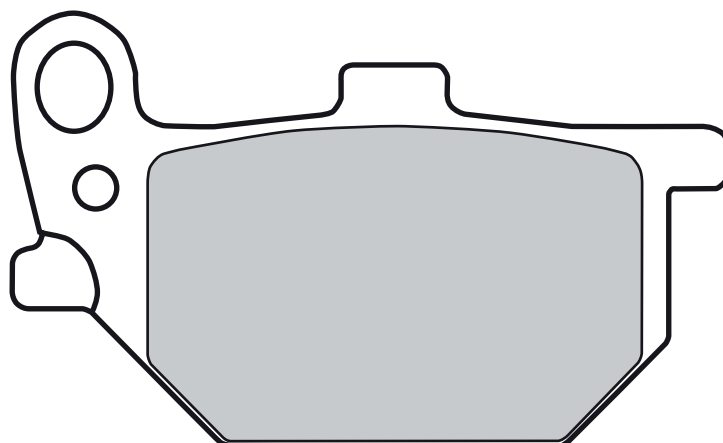
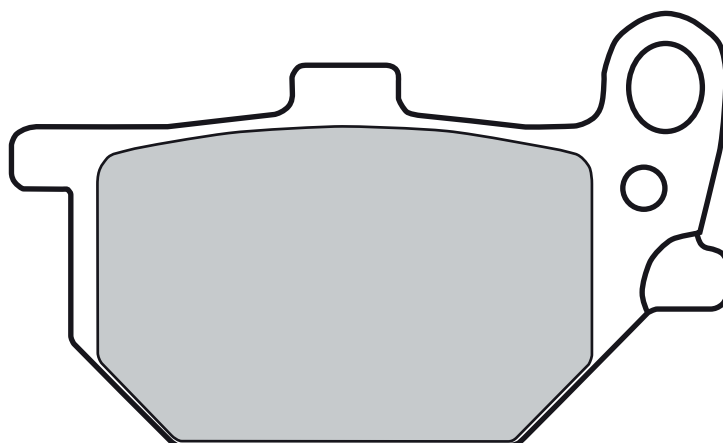

**YAMAHA**

250 RD DX right caliper	80 >	•
400 RD F, G	79 > 80	•
400 XS SE	80 > 81	•

650 XJ G, H, SH left caliper	80 >	•
650 XS G, H, J, K	80 > 82	•
750 XS H, J, K	81 > 82	•
750 XS SE, SG, LH	80 > 81	•
750 XV SE V-TWIN	81 >	•

850 XS SG, SH, LG, LH LEFT CALIPER	81 >	•
920 XV K, MK, VIRAGO	83 >	•
1100 XS SG, SH, LG right caliper	81 >	•





**07YA08.09** 65.4 x 59 x 10

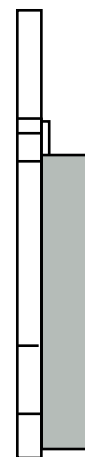
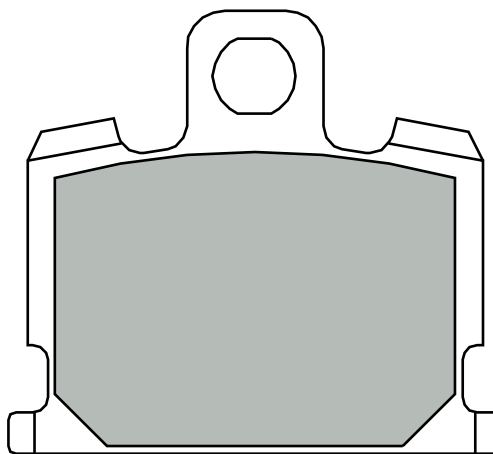

### YAMAHA

50	RD MX	81 >	•
50	RX K	83 >	•
80	RD	81 >	•
80	RX SPECIAL	82 >	•
250	RD LC	81 > 82	•
350	RD LC	81 > 82	•
400	XJ MAXIM, SECA	81 >	•

550	MAXIM	81 >	•
550	XJ H, J, RH, RJ	81 >	•
550	XJ K, MAXIM	83 >	•
550	XJ SECA	81 >	•
550	XZ	82 > 82	•
650	XJ SECA	81 >	•
750	MAXIM	81 >	•
750	XJA, RH, RJ	81 >	•

750	XJ SECA	81 >	•
920	XV J	82 >	•
920	XV VIRAGO	81 >	•
1000	XV	83 >	•
1100	MAXIM	81 >	•
1100	XJ J	82 >	•
1100	XJ LH	81 >	•
1100	XS S, SP	81 >	•



**07YA09.CC** 44.5 x 53.4 x 8.6

**07YA09.SA** “ “ “

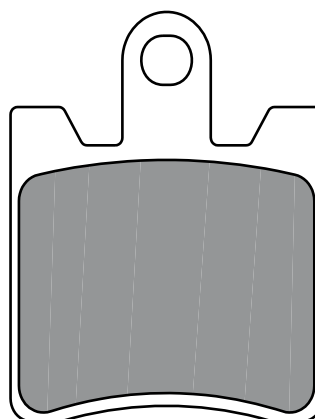

### TRIUMPH

1200	TROPHY	13 >	•
------	--------	------	---

### YAMAHA

1300	FJR A	13 >	•
1300	FJR ABS	06 >	•
1300	FJR AS	13 >	•



**07YA10.11** 68 x 58.6 x 10.7

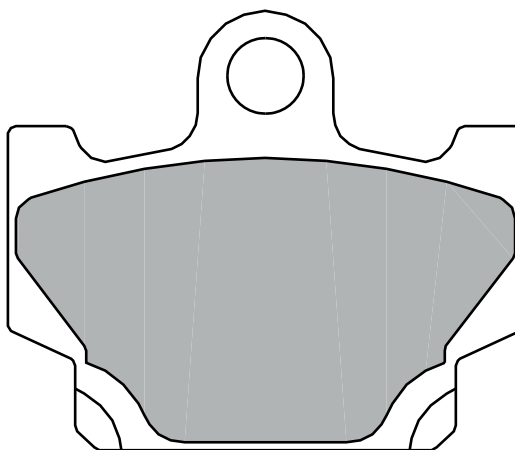

### YAMAHA

80 DT LC	81 > 82	•
80 RC LC	82 >	•
80 RD LC1-2	81 >	•
100 RX	84 >	•
115 RX S	82 >	•
125 RD LC	82 >	•
125 SR	92 >	•
240 XV VIRAGO	92 >	•

250 RD LC	83 >	•
250 XV	88 > 90	•
350 RD LC, LC YPVS	83 > 84	•
400 FZ N	87 >	•
400 XS	85 >	•
400 XS DOHC	82 >	•
400 XS MAXIM, SECA	82 >	•
400 XS RJ, RK, J, K	82 > 83	•
500 XT AUSTRIA	83 >	•
500 XV K VIRAGO	83 >	•

500 XV SE	83 >	•
500 XZ S	83 >	•
550 XZ	83 >	•
550 XZ RJ, RK	82 > 83	•
600 XT TENERE'	83 > 86	•
650 XJ J, L, LK	82 > 83	•
650 XJ T	81 >	•
650 XJ TURBO	83 >	•
750 XJ J, K, MK	82 >	•
920 XV K, MK, VIRAGO	83 >	•





<b>07YA11.07</b>	63.3 x 54.7 x 8.7
<b>07YA11.SA</b>	“ “ “
<b>07YA11.SP</b>	“ “ “

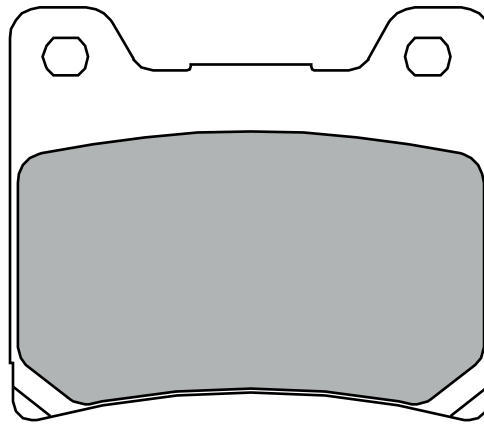

## YAMAHA

100 FJ L, LC	84 >	• •
100 RD	80 >	•
125 TZR	93 > 93	•
125 TZR	94 >	•
250 FZ PHAZER	85 >	•
250 RD LC	83 >	•
250 TDR	88 >	•
350 RD LC	85 > 85	• •
350 RD LC, LC YPVS	83 > 84	•
400 FZR	85 > 87	•
400 SRX	90 >	•
400 XS Z	83 >	• •
500 RD	83 > 84	• •
500 RD LC	85 >	•
600 FJ	84 >	• •
600 FZ S,SC	86 > 87	• •
600 FZR	89 > 89	• •
600 FZR	90 > 91	•
600 FZR	92 > 96	•
600 FZR R	94 > 95	•
600 SRX	88 > 89	•
600 SRX	90 >	•
600 XJ	83 > 90	• •
600 YX RADIAW	87 >	•
600 YZF R THUNDER CAT	96 >	•
700 FZ	87 >	•
700 FZX FAZER	87 >	• •

700 XJ	86 >	•
700 XJ MAXIM	85 >	•
700 XV L, LC	84 >	• •
700 XV VIRAGO	87 >	•
750 FZ	85 > 86	•
750 FZ GENESIS	87 > 88	• •
750 FZ GENESIS	89 >	•
750 FZR GENESIS	87 >	•
750 FZR R OW 01	89 >	•
750 FZX	86 > 87	• •
750 MAXIM	81 >	•
750 TX A	73 > 76	•
750 VF VIRAGO	88 >	•
750 XJ	83 > 86	• •
750 XV	89 > 92	•
750 YZF R	93 > 97	•
750 YZF SP	93 > 97	•
850 TDM	91 > 95	•
850 TDM	96 > 01	•
850 TRX	95 >	•
900 XJ DIVERSION	94 >	•
900 XJ F	83 > 86	• •
900 XJ N	83 > 86	• •
900 XJ S	94 >	•
900 XJ STRIDER	83 >	• •
920 XV VIRAGO	81 >	•
1000 FZR EX-UP	90 > 91	•
1000 FZR EX-UP	92 > 93	•
1000 FZR EX-UP	94 > 95	•

1000 FZR GENESIS	87 > 89	•
1000 GTS	93 >	•
1000 XV L, C	84 >	• •
1000 XV VIRAGO	86 > 93	•
1000 YZF THUNDER ACE	96 >	•
1100 BT BULLDOG	02 >	•
1100 FJ	83 >	• •
1100 FJ J	84 >	• •
1100 XV VIRAGO	86 > 93	•
1100 XV VIRAGO	99 >	•
1100 XVS DRAG STAR	99 >	•
1100 XVS DRAG STAR CLASSIC	00 >	•
1200 FJ	84 > 88	• •
1200 FJ	89 >	•
1200 FJ ABS	91 >	•
1200 V MAX	85 > 92	• •
1200 V MAX	93 > 98	•
1200 VXZ L, K2C	84 >	• •
1200 XJR	94 > 98	•
1200 XJR ITALIA	95 > 98	•
1200 XJR SP	97 > 98	•
1200 XV DL,DC2	84 >	• •
1200 XV VENTURE ROYALE	85 >	• •
1200 XV Z12T VENTURE	83 >	• •
1200 XVT VENTURE ROYALE	84 >	• •
1300 XJR	99 > 01	•
1300 XJR SP	99 > 01	•

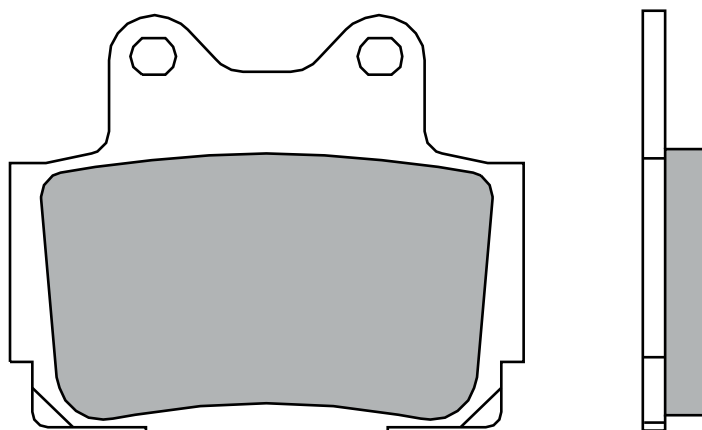

<b>07YA12.07</b>	67.8 x 55.9 x 8.7
<b>07YA12.SA</b>	“ “ “
<b>07YA12.SP</b>	“ “ “

**YAMAHA**

50 FZR	90 >	•
80 TZR	87 > 91	•
125 RD	87 >	•
125 RD LC YPVS	85 >	•
125 TZR	87 > 88	•
125 TZR	89 > 92	•
125 TZR R	94 >	•
200 SDR	88 >	• •
250 FZR	87 >	•
250 FZR R	89 >	•

250 FZX	91 >	•
250 FZX ZEAL	91 >	•
250 RZ RR	88 >	• •
250 SRX	87 >	•
250 TDR	89 >	•
250 TZR	87 > 88	•
250 TZR	89 > 92	•
350 RD F	85 >	• •
350 RD LC	86 > 92	• •
400 FZ N	87 >	•
400 FZR	85 > 87	•
400 FZR	88 > 89	•

400 FZR	90 >	•
400 FZR R	91 >	•
400 SRX	85 > 86	•
400 SRX	87 > 89	•
400 XJ DIVERSION	91 >	•
500 RD LC	85 >	•
600 FZS FAZER	98 > 03	•
600 SRX	86 > 87	• •
600 XJ DIVERSION	91 > 97	•
600 XJ DIVERSION	98 > 03	•
750 FZ	85 > 86	•
750 FZR	87 >	•

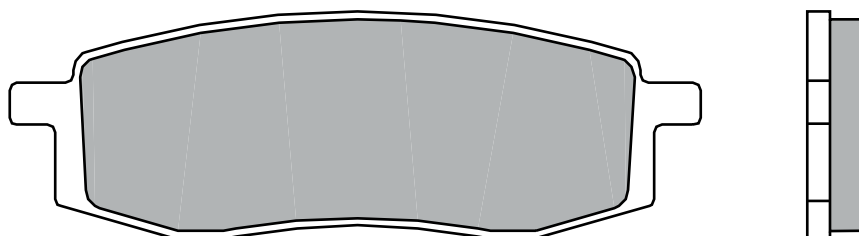

<b>07YA13.SD</b>	90.8 x 30.1 x 7.2
<b>07YA13.SX</b>	“ “ “
<b>07YA13.TT</b>	“ “ “

**YAMAHA**

125 YZ	85 > 87	•
125 YZ	88 > 88	•
200 IT	86 >	•

225 TT	86 >	•
250 NX	88 >	•
250 TT	87 > 92	•
250 YZ	85 > 87	•
250 YZ	88 > 88	•

350 TT	86 > 91	•
490 YZ	85 > 87	•
490 YZ	88 > 90	•
500 YZ	88 >	•
600 TT	90 > 92	•



<b>07YA14.07</b>	70.9 x 36.1 x 9.2
<b>07YA14.SD</b>	“ “ “
<b>07YA14.SX</b>	“ “ “

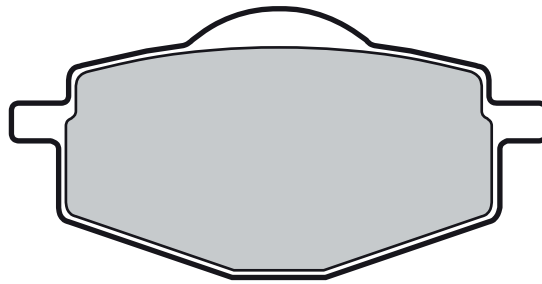

### GILERA

125 APACHE	91 > 93	•
125 RC TOP RALLY	89 >	•
250 OREGON QUAD	07 >	•
600 R, RC	91 >	•
600 RC	88 >	•

### YAMAHA

50 DTR MX	89 > 95	•
50 TDR	90 >	• •
50 TZM	94 >	•
50 TZR	90 > 92	•
50 Y SL T	87 >	•
50 Y SR	87 > 92	•
80 DT LC2	85 >	•
80 RD LC	83 > 86	•
80 RD LC	87 >	•
80 TDR	89 >	• •
80 YSR	86 > 88	•
125 DT LC	85 >	•
125 DT R	96 > 98	• •

125 DT R, ELECTRIC	88 >	• •
125 SR FLAME	96 >	•
125 TDR	93 >	• •
125 TDR R	93 >	•
125 TZR	89 > 92	•
125 XC F	00 >	•
125 YZ	88 > 88	•
180 RT	95 > 96	•
200 DT	84 > 88	•
200 DT R	85 > 87	•
200 DT R	89 >	• •
200 IT	85 > 85	•
200 TT	86 >	•
200 TW	90 > 91	•
225 SERROW	88 >	•
225 TT R S, T	01 >	•
225 TT T	87 > 00	•
225 XT E, F	92 > 00	•
250 IT	85 >	•
250 TY Z	96 >	•
250 WR	91 > 91	•
250 YZ	85 > 86	• •

250 YZ	88 > 88	•
350 XT	85 > 90	•
350 XT	91 >	•
350 XT B, G	91 > 96	•
350 YFM XT	87 > 88	•
350 YFM XT, XU WARRIOR	87 > 88	•
350 YFZ D	92 >	• •
350 YFZ T-W BANSHEE	87 > 89	•
400 ARTESIA	91 >	•
400 XT	86 >	•
490 YZ	88 > 90	•
500 WR	91 > 91	•
500 XT	86 >	•
500 XT E	90 > 96	•
500 YZ	88 >	•
600 DT N	85 >	•
600 TT	85 > 88	•
600 XT E	90 > 98	•
600 XT K	90 > 98	•
600 XT TENERE'	87 > 89	•
660 XTZ TENERE'	91 > 98	•



**07YA15.19** 46.5 x 46.5 x 16.3

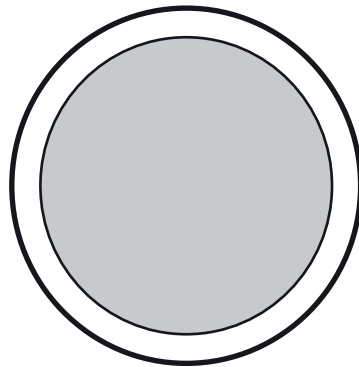

**YAMAHA**

125	YT	80 > 81	•
175	YT	82 > 83	•
200	YFM DXS-DXW MOTO 4	86 > 87	•
200	YFM N MOTO 4	85 > 89	•
200	YTM K-N TRI MOTO	83 > 85	•

225	YFM S-U MOTO 4	86 > 88	•
225	YTM DRN, DRS TRI MOTO	85 > 86	•
225	YTM DXK-DXN TRI MOTO	83 > 85	•
225	YTM DXN	83 > 84	•
250	YFM W, A, B	89 > 91	•

350	YFM E	87 > 92	•
350	YFM ERT, ERU	87 > 88	•
350	YFM ERW, ERA-G	89 > 95	•
350	YFM FWT, FWU BIG BEAR	87 > 88	•
350	YFM FWW, FWA-G BIG BEAR	89 > 95	•



**07YA16.05** 82.6 x 22 x 7.2

**07YA16.SD** “ “ “

**07YA16.SX** “ “ “



**YAMAHA**

50	DT LCD	98 >	•
80	YZ	86 > 92	•
80	YZ E, F, G, H1, J1	93 > 01	•
85	YZ	02 >	•
125	TT-R LW	00 >	•



<b>07YA17.11</b>	74.3 x 53.9 x 10.5
<b>07YA17.SA</b>	“ “ “
<b>07YA17.SP</b>	“ “ “

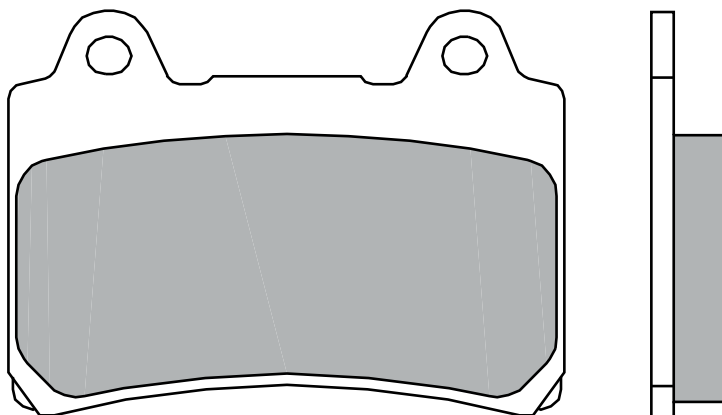

### YAMAHA

250 FZR	87 >	•
250 SRV	92 >	•
250 TDR	88 >	•
250 TDR	89 >	•
250 TZR	87 > 88	•
400 FZR	88 > 89	•
400 SRX	87 > 89	•
600 SRX	88 > 89	•

750 FZ GENESIS	89 >	•
750 FZR	87 >	•
850 TDM	91 > 95	•
1000 FZR GENESIS	87 > 89	•
1200 FJ	89 >	•
1200 FJ ABS	91 >	•
1300 XVZ A ROYAL STAR	96 > 98	•
1300 XVZ ROYAL STAR BOULEVARD	99 >	•

1300 XVZ ROYAL STAR TOUR C.	97 >	•
1300 XVZ TD VENTURE ROYALE	86 > 95	• •
1300 XVZ TF VENTURE STAR	99 >	•
1600 WILD STAR	99 >	•
1700 XV ROAD STAR WARRIOS	02 >	•



<b>07YA18.09</b>	71 x 38.7 x 10
<b>07YA18.SA</b>	“ “ “
<b>07YA18.TT</b>	“ “ “

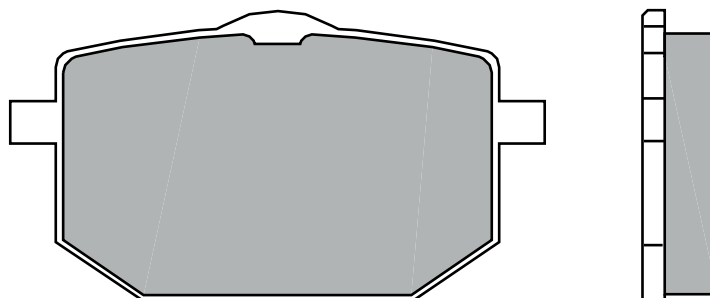

### MALAGUTI

50 MDX ENDURO	87 >	•
---------------	------	---

### YAMAHA

180 RT	90 > 93	•
600 TT	89 > 89	•
600 XT	86 > 89	•
600 XT TENERE'	87 > 89	•



**07YA19.09** 79.9 x 42.5 x 10

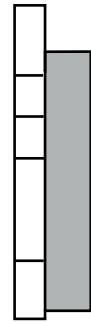
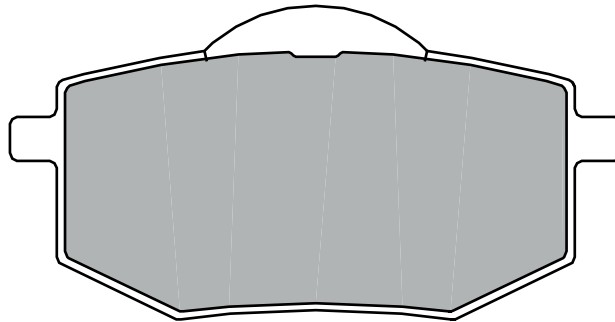

**YAMAHA**

250	XV VIRAGO	89 > 94	•
400	XV VIRAGO	88 >	•
535	XV VIRAGO	88 > 95	•



<b>07YA20.08</b>	76.9 x 41.9 x 8
	96.6 x 41.9 x 9.7

<b>07YA20.SP</b>	“	“	“
------------------	---	---	---

<b>07YA20.TT</b>	“	“	“
------------------	---	---	---

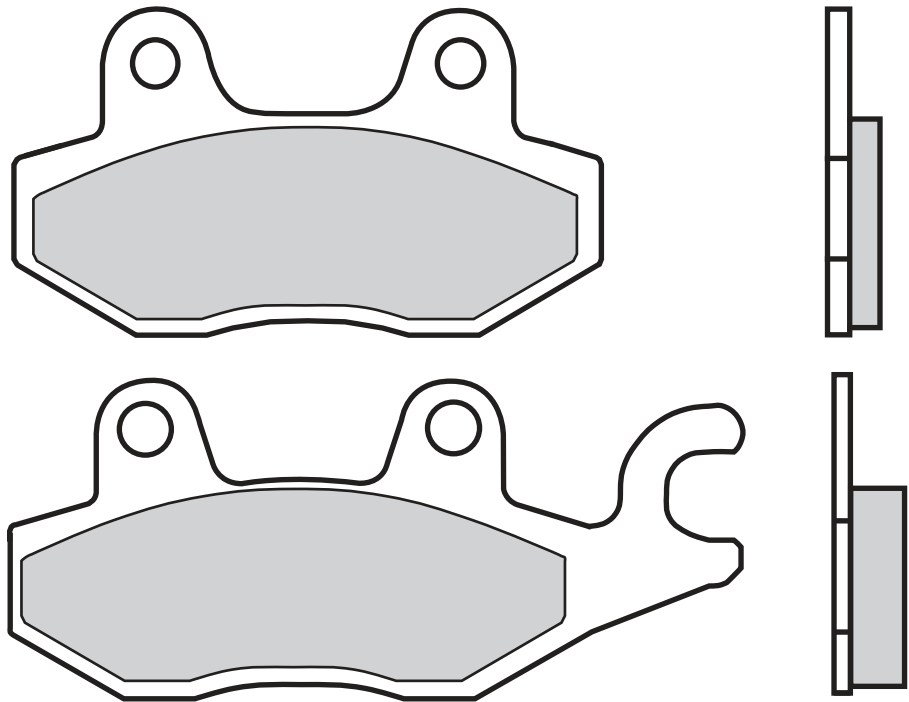

### MZ

125 RT	06 >	• •
125 SM	99 > 01	•
125 SM	02 >	•
125 SX	99 > 01	•
125 SX	02 >	•

### TRIUMPH

750 DAYTONA	91 > 92	•
750 TRIDENT right caliper	92 >	•
900 DAYTONA	91 > 94	•

900 DAYTONA SPEED TRIPLE	94 >	•
900 DAYTONA SPRINT	94 >	•
900 DAYTONA SUPER III	94 >	•
900 TIGER right caliper	92 > 98	•
900 TRIDENT right caliper	92 >	•
900 TRIDENT SPRINT right caliper	92 >	•
900 TROPHY	96 >	•
900 TROPHY right caliper	91 > 95	•
955 SPRINT ST	99 > 04	•

1000 DAYTONA	91 > 95	•
1200 DAYTONA	91 >	•
1200 TROPHY	96 >	•

### VOXAN

1000 SCRAMBLER	01 >	•
----------------	------	---

### YAMAHA

750 XTZ SUPERTENERE left caliper	89 >	•
----------------------------------	------	---



**07YA21.06** 76.9 x 41.9 x 8  
96.6 x 41.9 x 8

**07YA21.SA** “ “ “

**07YA21.SD** “ “ “

**07YA21.SX** “ “ “

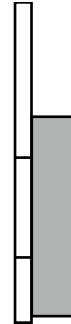
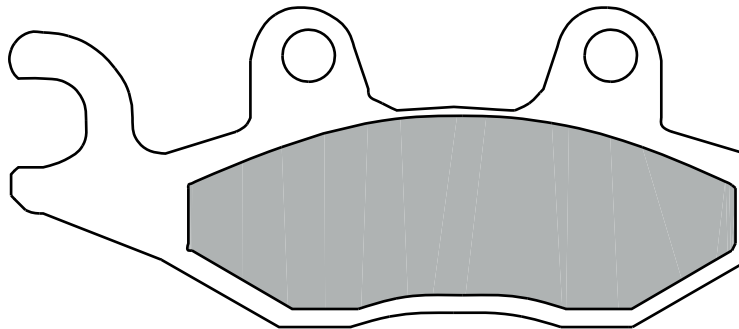
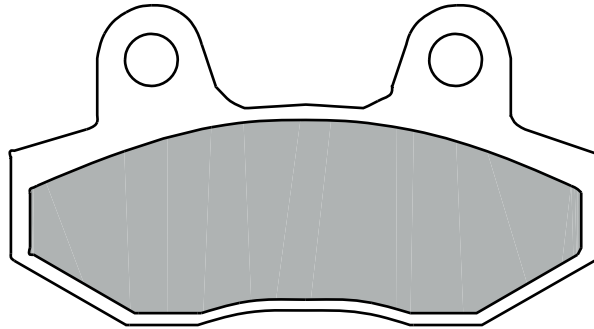

### BENELLI

125	CAFFE' NERO left/rear	08 >	• •
250	CAFFE' NERO	08 >	• •

### BOMBARDIER-CAN AM

800	COMMANDER LEFT/ REAR	11 >	•
800	COMMANDER RIGHT	11 >	•
1000	COMMANDER LEFT/ REAR	11 >	•
1000	COMMANDER MAX RIGHT	14 >	•
1000	COMMANDER RIGHT	11 >	•
1000	MAVERICK RIGHT	13 >	•

### CAGIVA

600	CANYON	95 >	•
-----	--------	------	---

### KAWASAKI

300	KLF C1-C12 BAYOU LEFT CALIPER	89 >	•
-----	-------------------------------	------	---

400	KLF BAYOU	93 > 99	•
650	KLR	08 >	•
650	KVF	05 >	•
650	KVF BRUTE FORCE 4X4I RIGHT	05 >	•
750	KVF BRUTE FORCE 4X4I LEFT	05 >	•

### SUZUKI

300	LT-F KING QUAD	02 >	•
450	LT-R	06 >	•
500	LT-A F QUADMASTER	00 >	•
500	LT-F F	98 >	•

### TRIUMPH

750	TRIDENT right caliper	92 >	•
800	TIGER EXPLORER	12 >	•
900	BONNEVILLE NEWCHURCH	15 >	•
900	BONNEVILLE SPIRIT	15 >	•
900	BONNEVILLE T214	15 >	•

900	DAYTONA SPRINT right caliper	93 >	•
900	SPEED TRIPLE	97 > 01	•
900	THRUXTON ACE	15 >	•
900	TIGER right caliper	92 > 98	•
900	TRIDENT right caliper	92 >	•
900	TRIDENT SPRINT right caliper	92 >	•
900	TROPHY right caliper	91 > 95	•
1000	TROPHY right caliper	91 > 95	•
1050	SPEED 94	15 >	•
1050	SPEED 94R	15 >	•
1050	TIGER SPORT	15 >	•
1200	TIGER EXPLORER	12 >	•
1200	TROPHY right caliper	91 > 95	•

### YAMAHA

230	TT-R	05 >	•
700	YFM R RAPTOR left	06 >	•
700	YFM RY left/rear	09 >	•
750	XTZ SUPERTENERE left caliper	89 >	•





<b>07YA22.06</b>	76.9 x 41.9 x 8
	96.6 x 41.9 x 8

<b>07YA22.SA</b>	“	“	“
------------------	---	---	---

<b>07YA22.SP</b>	“	“	“
------------------	---	---	---

<b>07YA22.SD</b>	“	“	“
------------------	---	---	---

<b>07YA22.SX</b>	“	“	“
------------------	---	---	---

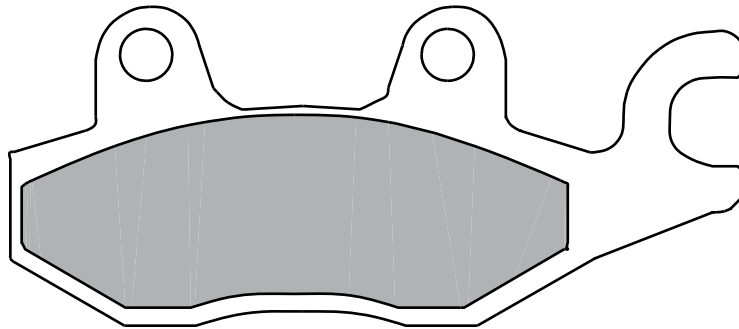
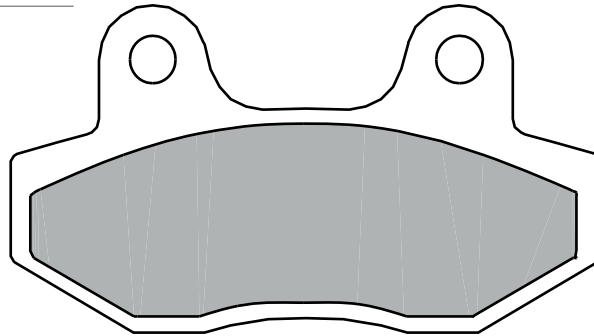

### AEON

125 OVERLAND	02 >	•
180 OVERLAND	02 >	•
180 ROADSTER	02 >	•

### ARCTIC CAT

50 DVX	06 >	•
90 DVX	06 >	•

### BENELLI

125 CAFFE' NERO right	08 >	•
250 CAFFE' NERO	08 >	•

### BOMBARDIER-CAN AM

800 COMMANDER LEFT/ REAR	11 >	•
1000 COMMANDER LEFT/ REAR	11 >	•
1000 COMMANDER MAX LEFT	14 >	•
1000 MAVERICK LEFT	13 >	•

### CAGIVA

500 CANYON	99 >	•
600 CANYON	95 >	•
900 CANYON I.E.	97 > 98	•
900 ELEFANT I.E.	90 >	•
900 GRAN CANYON	99 >	•
1000 NAVIGATOR	00 >	•

### HONDA

125 CB F	15 >	•
250 CA REBEL	90 >	•

### KAWASAKI

125 BN ELIMINATOR A3	00 >	•
250 EX R NINJA	08 > 12	• •
250 NINJA SL	15 >	• •
250 R NINJA	08 >	• •
250 Z SL	15 >	• •
300 KLF C1-C12 BAYOU RIGHT CALIPER	89 >	•
300 NINJA ABS	13 >	• •
300 Z	15 >	• •
400 KLF BAYOU	93 > 99	•

650 KLR	08 >	•
650 KVF BRUTE FORCE 4X4I LEFT	05 >	•
650 KVF RIGHT CALIPER	05 >	•
750 KRF TERYX 4X4 RIGHT	08 >	•
750 KVF BRUTE FORCE 4X4I RIGHT	05 >	•

### KREIDLER

125 FLORETT D	07 >	•
125 FLORETT RMC-F	07 >	•

### MOTOR UNION

250 HK HAOKE	97 >	•
--------------	------	---

### SUZUKI

125 BURGMAN ABS	14 >	•
200 BURGMAN ABS	14 >	•
300 LT-F KING QUAD	02 >	•
450 LT-R	06 >	•
500 LT-A F QUADMASTER	00 >	•
500 LT-F F	98 >	•
800 DR BIG	91 > 95	•



800 DR S	91 > 95	•
800 DR ST BIG	96 >	•

### TRIUMPH

750 TRIDENT left caliper	92 >	• •
900 BONNEVILLE	05 > 08	•
900 BONNEVILLE T100	05 > 08	•
900 DAYTONA SPRINT left caliper	93 >	• •
900 SPEED TRIPLE	94 > 96	•
900 TIGER left caliper	92 > 98	• •
900 TRIDENT left caliper	92 >	• •

900 TRIDENT SPRINT left caliper	92 >	• •
900 TROPHY left caliper	91 > 95	• •
955 TIGER	04 > 06	•
1000 TROPHY left caliper	91 > 95	• •
1050 TIGER	07 >	•
1050 TIGER SE	09 >	•
1200 TROPHY left caliper	91 > 95	• •

### YAMAHA

50 FZR	90 >	•
50 TZM	94 >	•

50 TZR	90 > 92	•
50 TZR	93 > 02	•
50 TZR	03 >	•
250 YBR	07 >	•
450 YXR RHINO	06 >	•
450 YZF S	04 > 05	•
660 RHINO right caliper	05 >	•
700 YFM R RAPTOR	06 >	•
700 YFM RY right	09 >	•
700 YXR RHINO left/rear	08 >	• •
750 XTZ SUPERTENERE right caliper	89 >	• •



<b>07YA23.07</b>	69.2 x 51.3 x 8.8
<b>07YA23.SA</b>	“ “ “
<b>07YA23.SC</b>	“ “ “
<b>07YA23.RC</b>	“ “ “

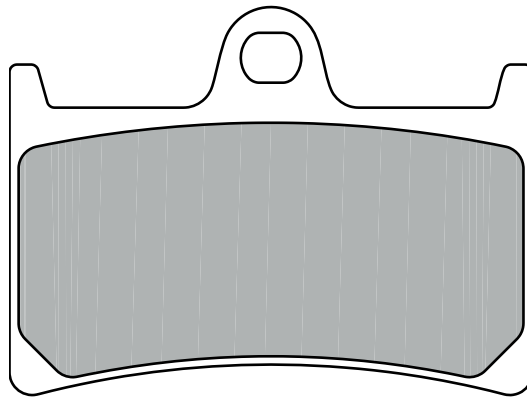

### YAMAHA

125 TZ	97 > •
125 TZR	94 > •
125 TZR R	94 > •
250 FZR R	89 > •
250 TZ	97 > •
250 TZR	89 > 92 •
400 FZR R	91 > •
600 FZ6 FAZER S2	07 > •
600 FZ6 FAZER S2 ABS	07 > •
600 FZ6 S2	07 > •
600 FZ6 S2 ABS	07 > •
600 FZS FAZER	98 > 03 •
600 YZF R THUNDER CAT	96 > •
600 YZF R6	99 > 02 •
600 YZF R6	03 > •
700 MT 07	14 > •
700 MT 07 MOTOCAGE	15 > •
700 XSR 700	16 > •
700 XSR 700 SPEED BLOCK	16 > •

750 YZF R7	99 > •
800 FZ 8	10 > •
800 FZS FAZER	10 > •
850 MT 09	14 > •
850 MT 09 ABS	14 > •
850 MT 09 SPORT TRACKER	15 > •
850 MT 09 STREET RALLY	14 > •
850 MT 09 STREET RALLY ABS	14 > •
850 MT 09 TRACER	15 > •
900 TDM	02 > •
900 TDM ABS	05 > •
900 XSR 900	16 > •
900 XSR 900 SPEED BLOCK	16 > •
1000 FZ1	06 > •
1000 FZ1 FAZER	06 > •
1000 FZS FAZER	01 > 05 •
1000 MT-10	16 > •
1000 YZF R1	98 > 01 •
1000 YZF R1	02 > 03 •
1000 YZF R1	04 > 06 •

1000 YZF R1	15 > •
1000 YZF R1 SP	06 > •
1000 YZF R1M 60th ANNIVERSARY	16 > •
1000 YZF R1M SPECIAL EDITION	15 > •
1000 YZF THUNDER ACE	96 > •
1100 BT BULLDOG	02 > •
1200 XTZ SUPERTENERE	10 > •
1300 FJR	01 > •
1300 XJR	99 > 01 •
1300 XJR	02 > •
1300 XJR RACER	15 > •
1300 XJR SP	99 > 01 •
1700 MT-01	05 > •
1700 XV PC ROAD STAR WARRIOR	03 > •
1700 XV ROAD STAR WARRIOS	02 > •
1900 XV MIDNIGHT STAR	06 > •



<b>07YA24.09</b>	74.6 x 54.1 x 9
<b>07YA24.SA</b>	“ “ “
<b>07YA24.SC</b>	“ “ “

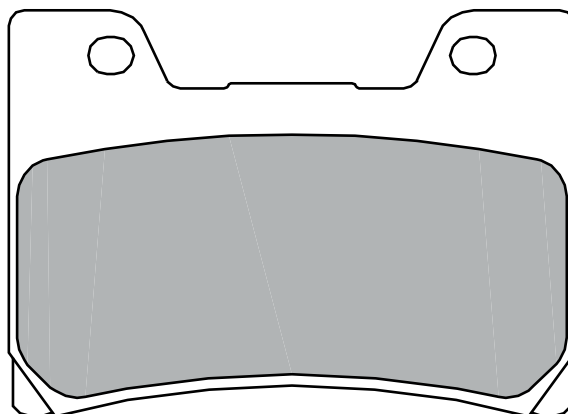

### YAMAHA

400 SRX	90 > •
600 FZR	90 > 91 •
850 TDM	96 > 01 •
1000 FZR EX-UP	90 > 91 •
1200 V MAX	93 > 98 •



**07YA25.08** 88.2 x 46.1 x 9.9

104.1 x 46.1 x 9.9

**07YA25.SA** “ “ “

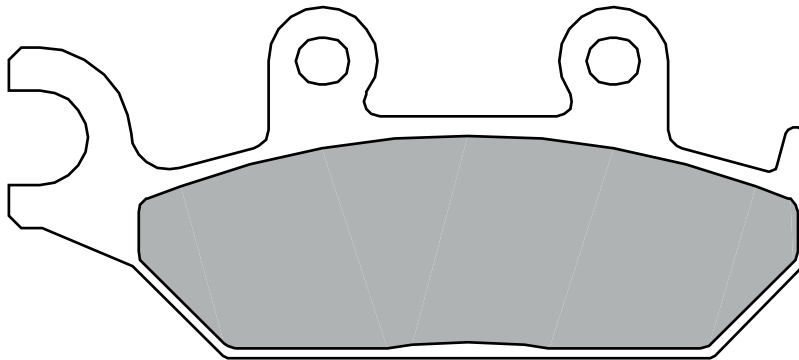
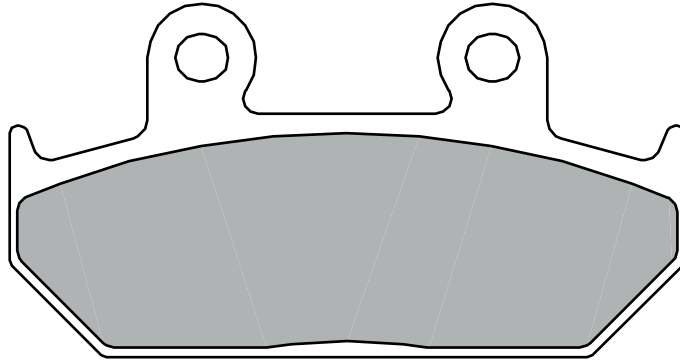

**YAMAHA**

50	TZR	93 > 02	•
350	XT	91 >	•
400	ARTESIA	91 >	•
500	XT E	90 > 96	•
600	XT E	90 > 98	•
600	XT K	90 > 98	•
660	XTZ TENERE'	91 > 98	•



<b>07YA26.09</b>	74.6 x 54.1 x 9
<b>07YA26.SA</b>	“ “ “
<b>07YA26.SC</b>	“ “ “

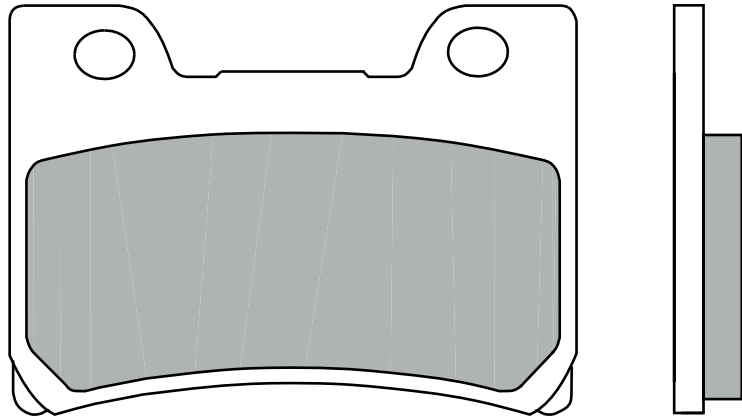

### YAMAHA

600 FZR	92 > 96	•
600 FZR R	94 > 95	•
1000 FZR EX-UP	92 > 93	•



<b>07YA27.09</b>	102 x 40.4 x 10
<b>07YA27.SA</b>	“ “ “

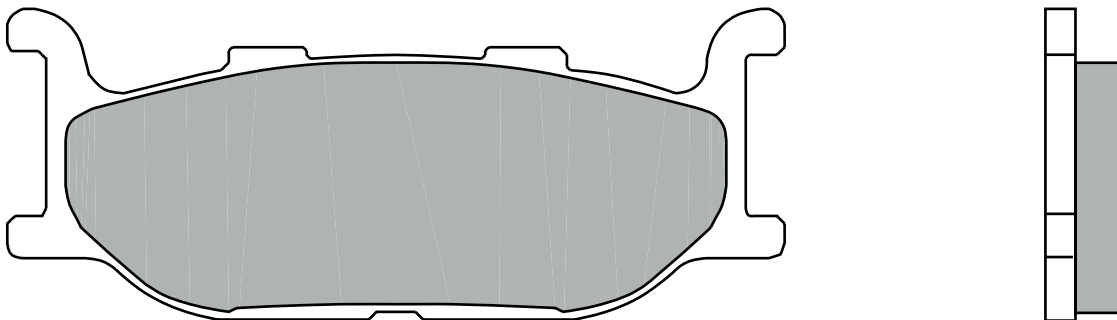

### SUZUKI

250 SRV	92 >	•
---------	------	---

### YAMAHA

250 FZX	91 >	•
250 FZX ZEAL	91 >	•
400 XJ DIVERSION	91 >	•
535 XV VIRAGO	96 > 98	•

600 XJ DIVERSION	91 > 97	•
650 XVS DRAG STAR CLASSIC	97 > 98	•
750 XV	94 > 95	•
900 XJ DIVERSION	94 >	•
900 XJ S	94 >	•
950 XV 950 SPEED BLOCK RACER	16 >	•

950 XV BOLT C-SPEC	15 >	•
950 XV950	16 >	•
950 XVS	09 > 13	•
950 XVS BOLT	14 >	•
1100 XV VIRAGO	94 > 95	•
1300 STRYKER	11 >	•
1300 XVZ TF VENTURE STAR	99 >	•
1600 WILD STAR	99 >	•



**07YA28.CC**

109.8 x 51 x 8.4

95.2 x 36.9 x 8.4

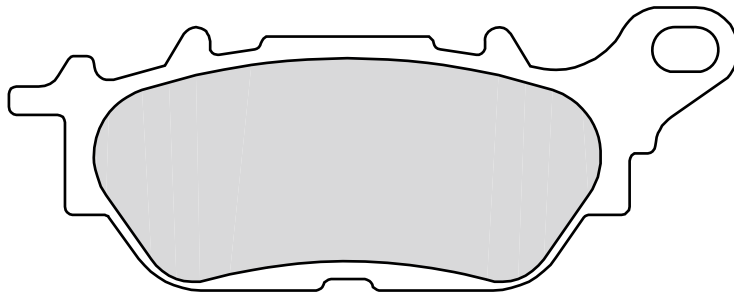
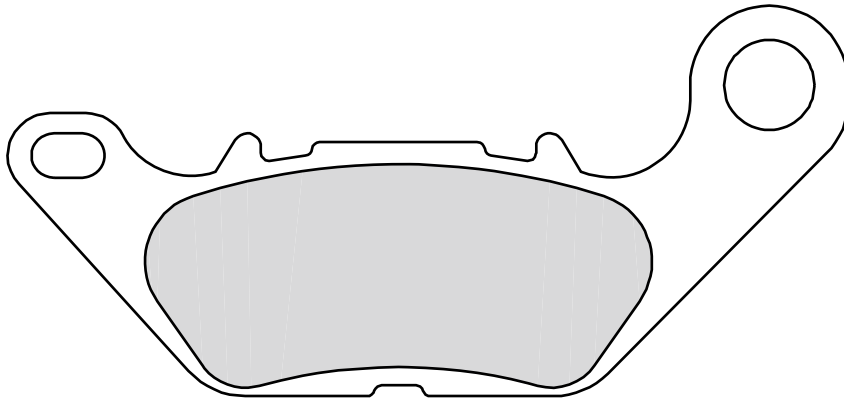

**MBK**

125 XC WAAP 08 > •

**YAMAHA**

115 D'ELIGHT 14 > •

125 YBR 08 > •

135 CRYPTON X 08 > •





**07YA29.CC** 47.8 x 44.5 x 7.1

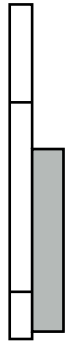
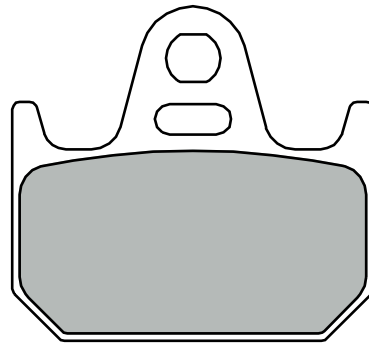

**YAMAHA**

125 TZ	97 >	•
250 TZ	97 >	•
250 TZR R	94 >	•



**07YA31.08** 131.7 x 81.4 x 9.6

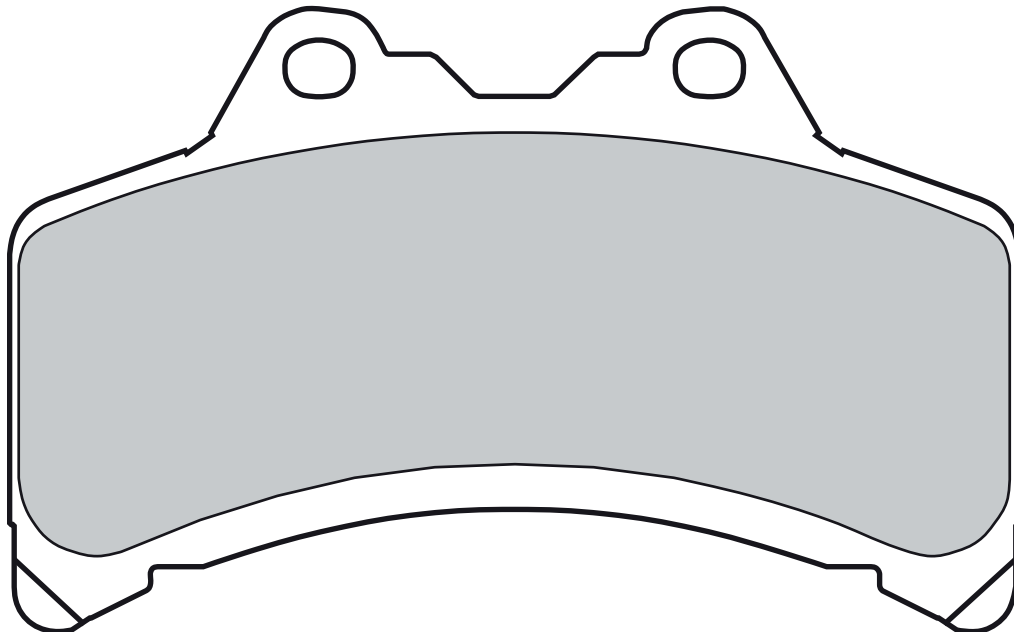

**YAMAHA**

1000 GTS	93 >	•
----------	------	---



**07YA32.08** 98.8 x 49.7 x 9.5

**07YA32.SA** “ “ “

**07YA32.SC** “ “ “

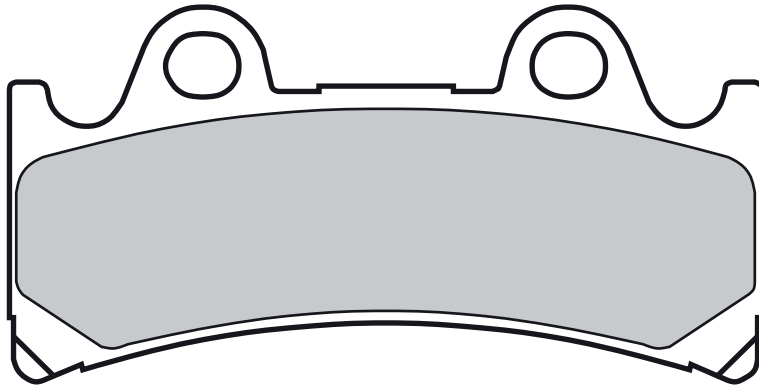

**TRIUMPH**

900 DAYTONA SUPER III 94 > •

**YAMAHA**

750 YZF R	93 > 97	•
750 YZF SP	93 > 97	•
1000 FZR EX-UP	94 > 95	•







**07YA34.08** 94 x 40.7 x 10

**07YA34.SA** “ “ “

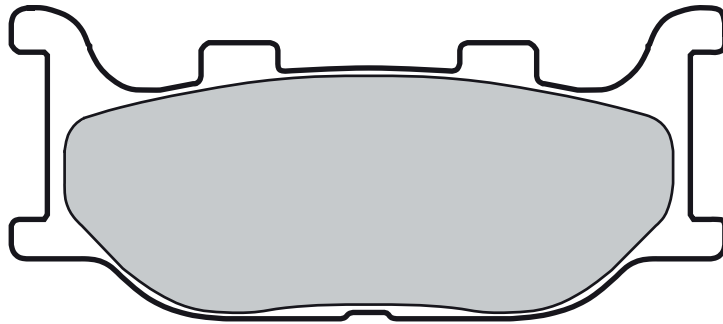

### BAOXIN

125 BX L 97 > •

### KEEWAY

250 SUPERSHADOW 06 > •

### MZ

1000 MUZ S 01 > 02 •

### YAMAHA

125 TDR R 93 > •

125 TZR 93 > 93 •

125 XV S DRAG STAR 00 > •

125 XV VIRAGO 97 > •

250 XV S VIRAGO 95 > 98 •

250 XV VIRAGO 95 > 98 •

250 XVS DRAG STAR 01 > •

400 SR 14 > •

600 FZ 6 04 > •

600 FZ 6 FAZER 04 > •

600 FZ 6R 09 > •

600 XJ 6 09 > •

600 XJ 6 N 13 > 13 •

600 XJ 6 N SP 13 > 13 •

600 XJ 6 NA ABS 13 > 13 •

600 XJ 6 S DIVERSION 13 > 13 •

600 XJ DIVERSION 98 > 03 •

600 XJ S F DIVERSION 10 > 11 •

600 XJ S FA DIVERSION ABS 11 > 11 •

660 MT-03 06 > •

1100 XV VIRAGO 99 > •

1100 XVS DRAG STAR 99 > •

XVS DRAG STAR 00 > •

1100 CLASSIC

1300 XVS CUSTOM 14 > •

1300 XVS MIDNIGHT STAR 07 > •



**07YA35.07** 74.3 x 53.9 x 8.8

**07YA35.SA** “ “ “

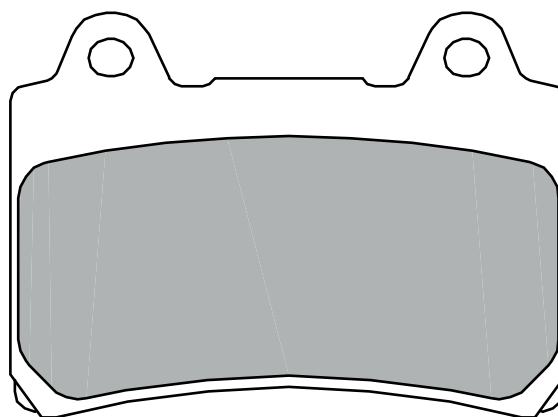

### YAMAHA

400 FZR 90 > •

400 SRX 85 > 86 •

600 SRX 90 > •

750 FZR GENESIS 87 > •

1200 XJR 94 > 98 •

1200 XJR SP 97 > 98 •

1300 XVZ A ROYAL STAR 96 > 98 •

1300 XVZ ROYAL STAR

BOULEVARD 99 > •

1300 XVZ ROYAL STAR

TOUR C. 97 > •



**07YA37.07** 99.6 x 31 x 9

**07YA37.SP** “ “ “

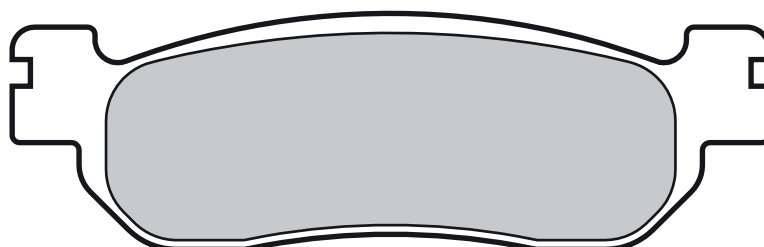

### YAMAHA

125 TW	99 >	•
175 DT	00 >	•
200 TW	01 >	•
225 BRONCO, CELLOW	97 >	•
225 XT	01 >	•
250 TRICKER	05 >	•
600 YZF R6	99 > 02	•
1000 YZF R1	02 > 03	•



**07YA38.07** 51.6 x 59.7 x 8.7

**07YA38.SP** “ “ “

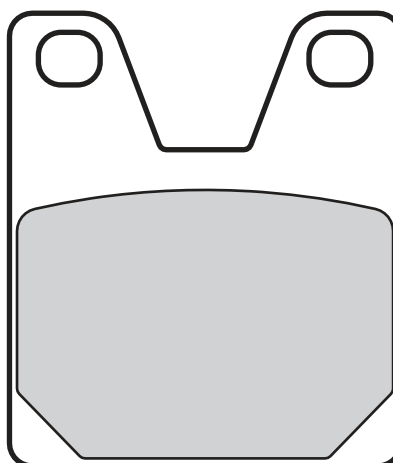

### HYOSUNG

700 I DELUXE	13 >	•
--------------	------	---

### YAMAHA

750 YZF R7	99 >	•
1000 YZF R1	98 > 01	•



**07YA39.08** 99.6 x 38.2 x 9.5  
**07YA39.SP** “ “ “

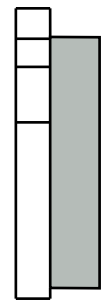
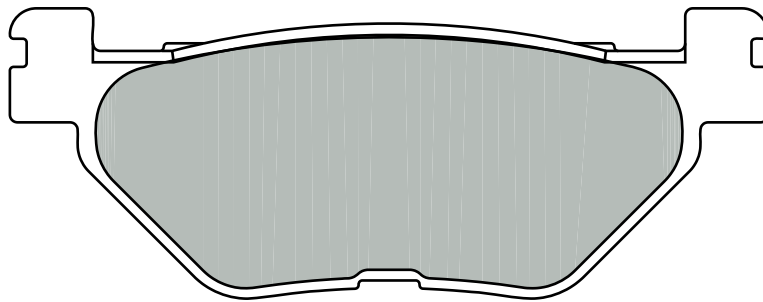

### YAMAHA

900 TDM	02 >	•
900 TDM ABS	05 >	•
950 XV 950 SPEED BLOCK RACER	16 >	•
950 XV BOLT C-SPEC	15 >	•
950 XV950	16 >	•

950 XVS	09 > 13	•
950 XVS BOLT	14 >	•
1200 XTZ SUPERTENERE	10 >	•
1300 FJR	01 >	•
1300 FJR A	13 >	•
1300 FJR ABS	06 >	•
1300 FJR AS	13 >	•

1300 STRYKER	11 >	•
1300 XVS CUSTOM	14 >	•
1300 XVS MIDNIGHT STAR	07 >	•
1700 V-MAX	09 >	•
1700 XV PC ROAD STAR WARRIOR	03 >	•
1900 XV MIDNIGHT STAR	06 >	•



**07YA40.07** 63.2 x 58.9 x 8.7  
**07YA40.SP** “ “ “

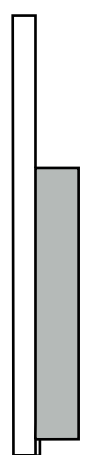
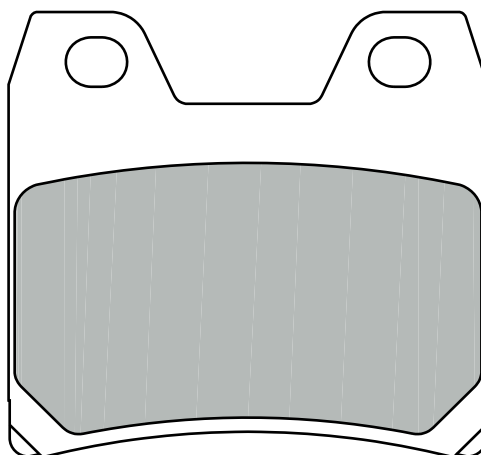

### YAMAHA

1000 FZS FAZER	01 > 05	•
1300 XJR	02 >	•
1300 XJR RACER	15 >	•



**07YA41.SD** 67 x 35.9 x 9.3

**07YA41.SX** “ “ “

**07YA41.TT** “ “ “

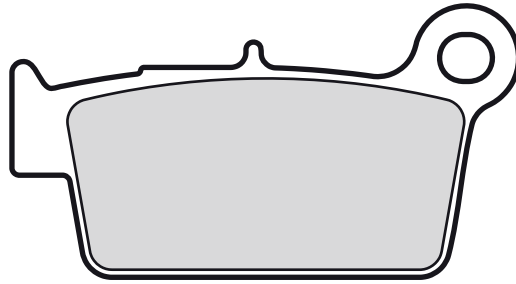
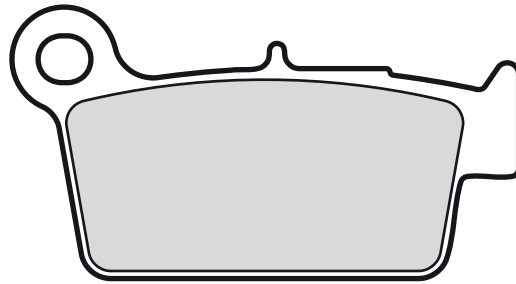

### APRILIA

450 MX V	09 >	•
450 RXV	06 >	•
450 SXV	06 >	•
450 SXV VAN DEN BOSCH REPLICA	08 >	•
550 RXV	06 >	•
550 SXV	06 >	•
550 SXV VAN DEN BOSCH REPLICA	08 >	•

### BETA

125 ALP 4-STROKE	06 >	•
125 M4	06 >	•
200 ALP 4-STROKE	06 >	•
250 RR	05 >	•
250 RR ENDURO	05 >	•
300 RR CROSSTRAINER	15 >	•
300 RR EFI	15 >	•
300 RR EFI RACING	15 >	•
300 RR ENDURO	13 >	•
350 ALP 4.0	06 >	•
350 RR ENDURO	12 >	•
390 RR	15 >	•
400 RR	05 >	•
400 RR ENDURO	05 >	•
430 RR	15 >	•
430 RR RACING	15 >	•
450 RR	05 >	•
450 RR CROSS COUNTRY	12 >	•
450 RR ENDURO	05 >	•
480 RR	15 >	•
480 RR RACING	15 >	•
498 RR ENDURO	12 >	•
525 RR	05 > 09	•
525 RR ENDURO	05 >	•

### BIMOTA

300 BBX ENDURO	12 >	•
----------------	------	---

### CCM

450 ENDURO	08 >	•
450 MX	08 >	•

### GAS GAS

250 EC	12 >	•
300 EC	12 >	•

### KAWASAKI

250 KX F	04 >	•
450 KLX R	07 >	•
450 KX F	06 >	•
450 KX F	09 >	•

### SHERCO

250 2.5 I ENDURO	06 > 11	•
250 SX 2.5	09 > 10	•
300 SE 3.0	10 >	•
300 SE 3.0I-F	10 > 11	•
450 4.5 I SUPERMOTARD	06 >	•
450 ENDURO	05 > 11	•
510 5.1 I ENDURO	06 > 11	•

### SUZUKI

125 DR SM	08 >	•
250 RM Z	04 >	•
400 DRZ SM	05 >	•
450 RM-Z	05 >	•
450 RM-Z EFI	08 >	•
450 RMX Z	10 >	•

### TM

125 ENDURO	05 >	•
------------	------	---

125 MX	06 >	•
250 ENDURO	05 >	•
250 F	05 >	•
250 F ENDURO	05 >	•
250 MX	06 >	•
300 MX	05 >	•
450 F	05 >	•
450 F ENDURO	05 >	•
530 F	05 >	•
530 F ENDURO	05 >	•

### YAMAHA

125 YZ	03 > 07	•
125 YZ	08 >	•
250 WR F	03 >	•
250 WR R	08 >	•
250 WR X	08 >	•
250 YZ	03 > 07	•
250 YZ	08 >	•
250 YZ F	03 > 06	•
250 YZ F	07 > 15	•
250 YZ F	16 >	•
250 YZ FX	15 >	•
450 WR F	03 >	•
450 YZ F	03 > 07	•
450 YZ F	08 > 15	•
450 YZ F	16 >	•

### ZERO

2.8 ZF FX	13 > 13	•
2.8 ZF MX	13 > 13	•
2.8 ZF XU	13 > 13	•
5.7 ZF FX	13 > 13	•
5.7 ZF MX	13 > 13	•
5.7 ZF XU	13 > 13	•
8.5 ZF DS	13 > 13	•
8.5 ZF S	13 > 13	•
11.4 ZF DS	13 > 13	•
11.4 ZF S	13 > 13	•



**07YA44.SD** 39.3 x 39.3 x 23.1  
37 x 37 x 7.8

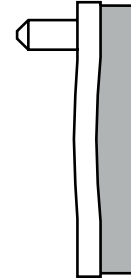
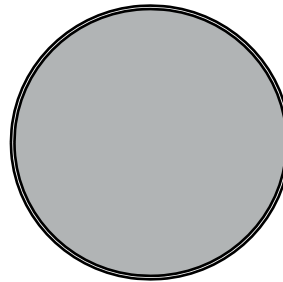
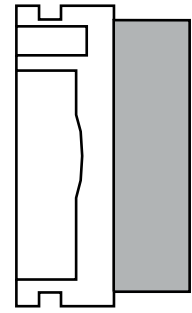
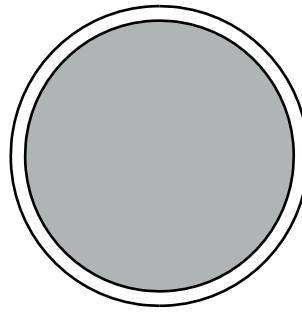

**YAMAHA**

200 YFS U-P BLASTER 88 > 02 •



**07YA45.SD** 65.1 x 44.4 x 11.6

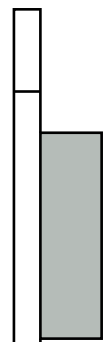
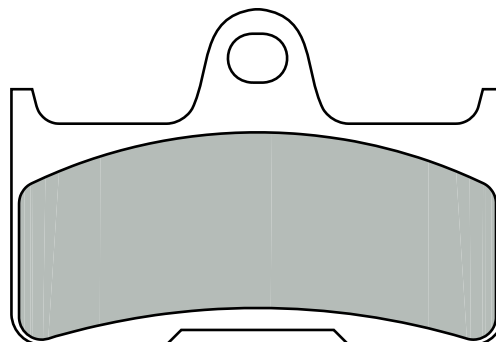

**YAMAHA**

660 YFM GRIZZLY FWAP 4X4 02 > •



**07YA46.SA** 61.6 x 44.6 x 8.5

30.6 x 48 x 8.5

**07YA46.SC** “ “ “

**07YA46.RC** “ “ “

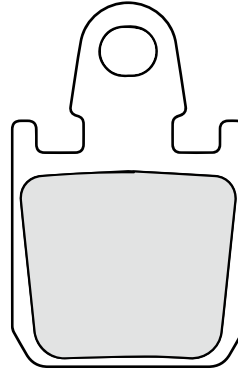
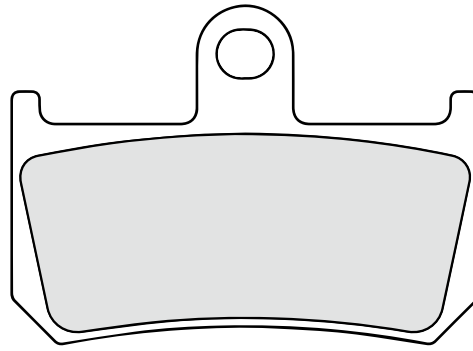

**YAMAHA**

1000 YZF R1	07 > 14	•
1700 MT-01	07 >	•
1700 V-MAX	09 >	•



0821 000 555



0821 000 777



+33 3 89 70 3000



+33 3 89 70 30 99



**07YA47.SD** 93.8 x 31.1 x 7.2

**07YA47.SX** “ “ “

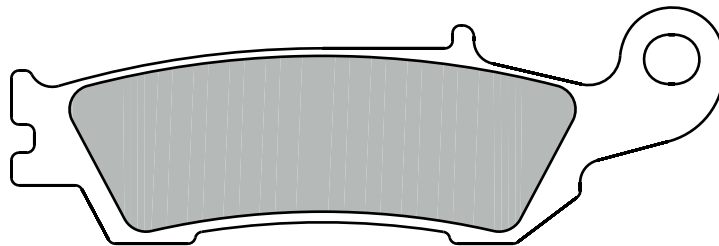
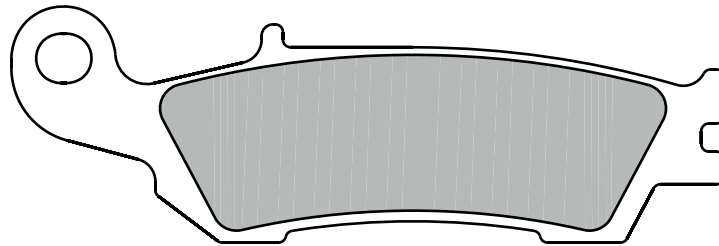

**YAMAHA**

125 YZ	08 >	•
250 YZ	08 >	•
250 YZ F	07 > 15	•
250 YZ FX	15 >	•
450 YZ F	08 > 15	•



**07YA48.SD** 106.6 x 35.8 x 7.5

91.1 x 36.2 x 7.5

**07YA48.SX** “ “ “

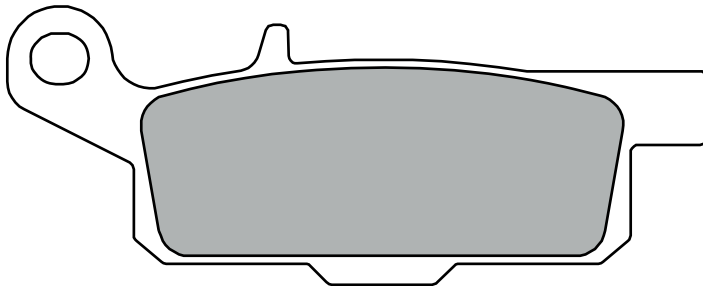
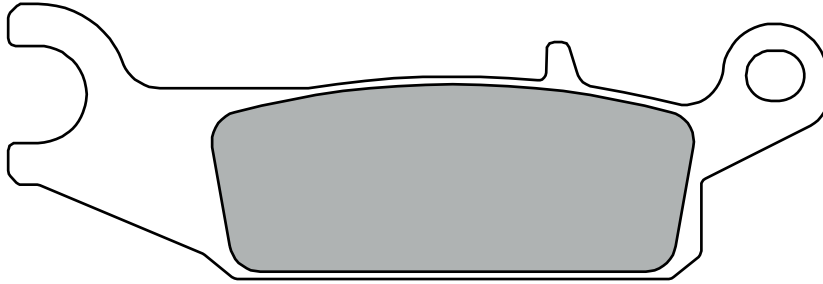

**YAMAHA**

250	YFM RAPTOR right	09 >	•
550	YFM FGPW GRIZZLY right	09 >	•
700	YFM FGPW GRIZZLY right	07 >	•





**07YA49.SD** 106.6 x 35.8 x 7.5  
91.1 x 36.2 x 7.5

**07YA49.SX** “ “ “

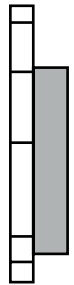
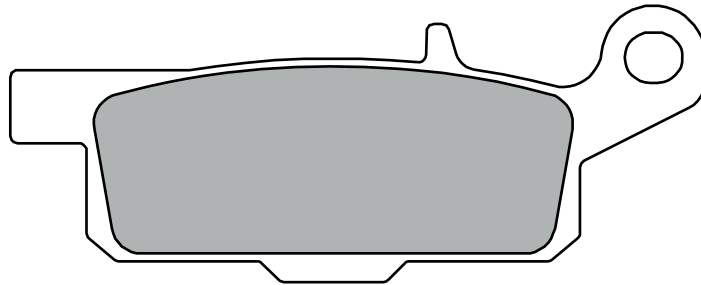
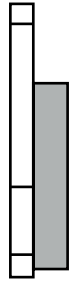
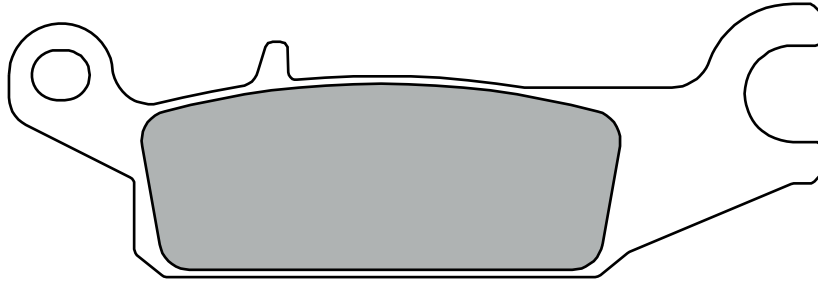

**YAMAHA**

250	YFM RAPTOR left/rear	09 >	•
550	YFM FGPW GRIZZLY left	09 >	•
700	YFM FGPW GRIZZLY left	07 >	•



**07YA50.SD** 106.6 x 35.8 x 8.9

91.1 x 36.2 x 8.9

**07YA50.SX** “ “ “

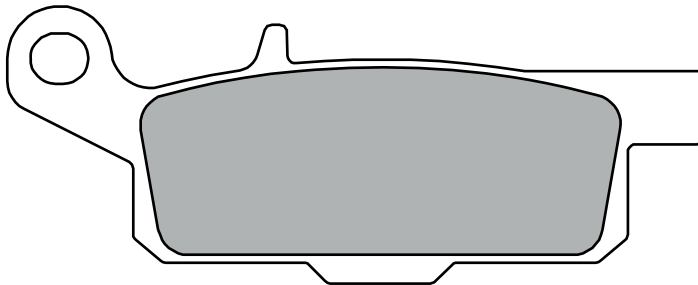
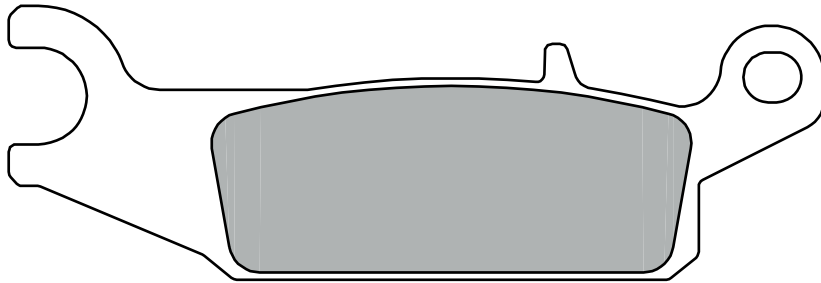

**YAMAHA**

550	YFM FGPW GRIZZLY right	09 >	•
700	YFM FGPW GRIZZLY right	07 >	•



**07YA51.SD** 106.6 x 35.8 x 8.9

91.1 x 36.2 x 8.9

**07YA51.SX** “ “ “

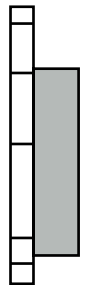
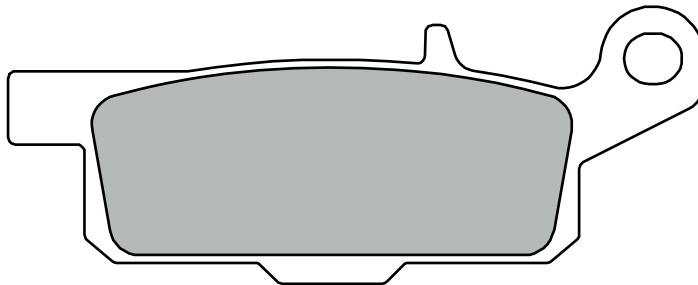
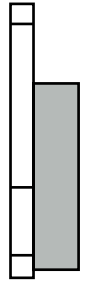
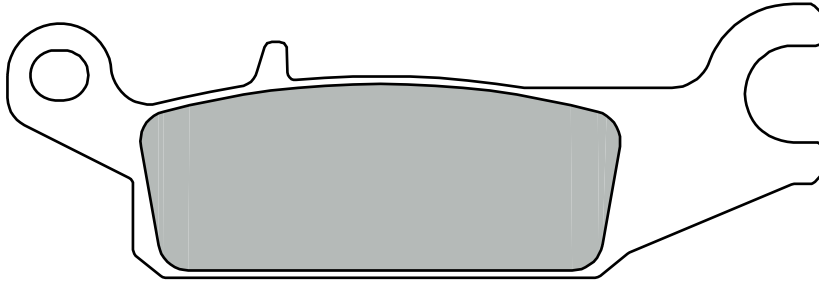

**YAMAHA**

- 550 YFM FGPW GRIZZLY left 09 > •
- 700 YFM FGPW GRIZZLY left 07 > •

# SEGNI PASTIGLIE E LORO APPLICAZIONE PER SCOOTER

PAD DRAWINGS AND THEIR SCOOTER APPLICATIONS

LISTE DES APPLICATIONS SCOOTER ET CROQUIS

ZEICHNUNGEN DER BELAGEN UND ANWENDUNG FUER  
SCOOTER

DISEÑO DE PASTILLAS Y SU APLICACIÓN PARA SCOOTER



0821 000 555



0821 000 777



+33 3 89 70 3000



+33 3 89 70 30 99



**07YA52.CC** 113.1 x 54.7 x 8.3  
98.4 x 44.5 x 8.3

**07YA52.SA** “ “ “

**07YA52.SC** “ “ “

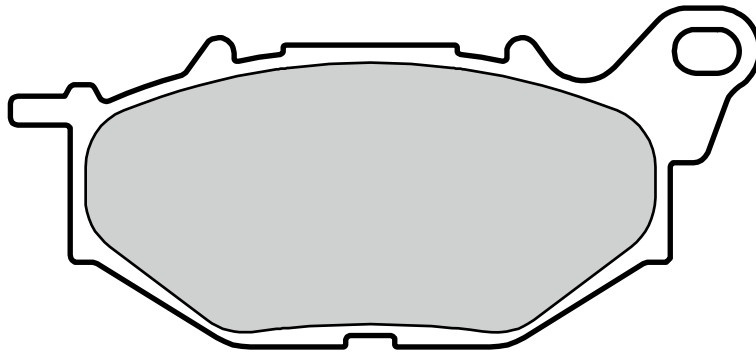
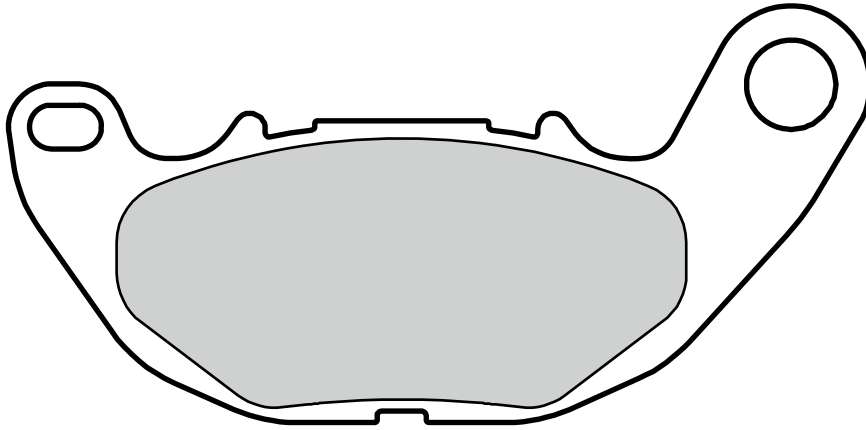

**YAMAHA**

250	YZF R25	15 >	•
321	MT-03	16 >	•
321	YZF R3	15 >	•



**07YA53.CC** 113.1 x 52.7 x 10.5  
97.1 x 39.4 x 10.5

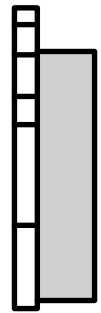
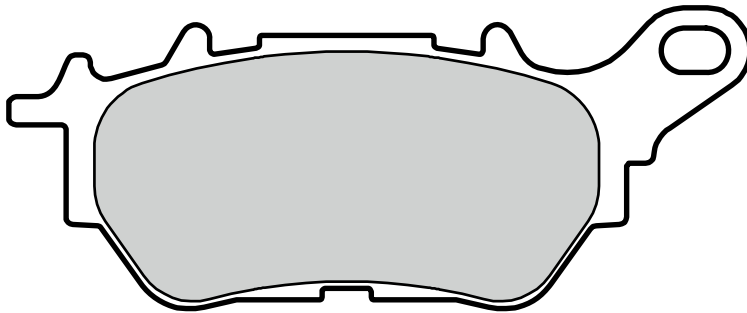
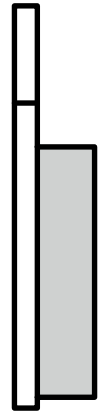
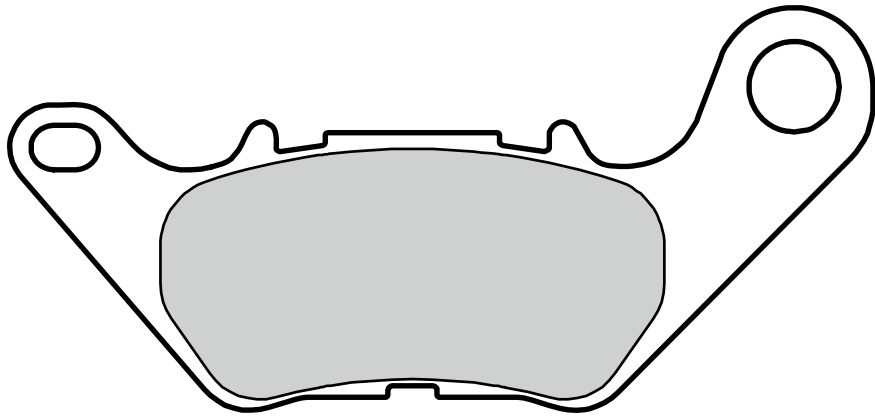

**YAMAHA**

250	YZF R25	15 >	•
321	MT-03	16 >	•
321	YZF R3	15 >	•





<b>07001.CC</b>	94 x 36.2 x 8
<b>07001.12</b> GENUINE	“ “ “
<b>07001.23</b> GENUINE	“ “ “
<b>07001.35</b> GENUINE	“ “ “
<b>07001.78</b> GENUINE	“ “ “
<b>07001.XS</b>	“ “ “

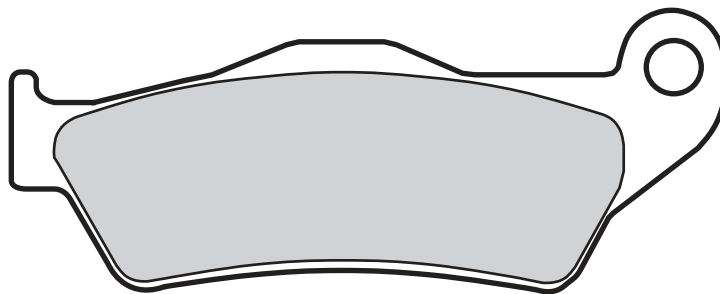

### GILERA

500 NEXSUS (EURO 3)	06 >	•
500 NEXSUS SP (EURO 3)	06 >	•
500 NEXUS	03 > 05	•
800 GP 800	07 >	•

### MBK

125 SKYLINER	99 > 01	•
125 SKYLINER	02 >	•
125 THUNDER	01 >	•
150 SKYLINER	00 > 00	•
150 SKYLINER	01 >	•

150 THUNDER

180 SKYLINER

300 XC KILIBRE

02 >

•

04 >

•

03 >

• •

### PIAGGIO

400 BEVERLY I.E.	06 >	•
500 X9 EVOLUTION	04 >	•
500 X9 EVOLUTION ABS	04 >	•

### SUZUKI

125 BURGMAN	01 > 06	•
150 BURGMAN	04 >	•



### YAMAHA

125 MAJESTY	98 > 00	•
125 MAJESTY	01 >	•
125 MAXSTER	01 >	•
150 MAJESTY	98 > 00	•
150 MAJESTY	01 >	•
150 MAXSTER	01 >	•
180 MAJESTY	03 > 03	•
180 MAJESTY	04 >	•
300 XC VERSITY	03 > 04	• •
300 XC VERSITY	05 >	•



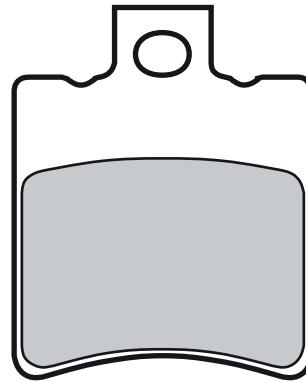

**07002.CC** 39.7 x 49.5 x 6.3**07002.18**  
GENUINE “ “ “**07002.23**  
GENUINE “ “ “**07002.34**  
GENUINE “ “ “**APRILIA**

50	AMICO	92 > 94	•
50	BUSINESS	97 >	•
50	CLASSIC	96 >	•
50	CLUB	97 >	•
50	MC GULLIVER	95 >	•
50	RALLY	96 >	•
50	RALLY AC	96 >	•
50	RALLY LC	92 > 96	•
50	RALLY LC	97 >	• •
50	SCARABEO	94 > 97	•
50	SCARABEO	98 > 01	•
50	SCARABEO BRIGHT	98 >	• •
50	SCARABEO DE LUXE	98 >	• •
50	SCARABEO DITECH	02 >	•
50	SCARABEO STREET	98 >	•
50	SONIC GP	98 >	•
50	SONIC SPICE	98 >	•
50	SR DITECH	00 >	•
50	SR R	05 >	•
50	SR R FACTORY	05 >	•
50	SR R FACTORY REPLICA		
50	SBK	10 >	•
50	SR RACING	97 >	• •
50	SR STEALTH LC	97 >	• •
50	SR STREET	05 >	•
50	YOUNGER	97 >	•
125	LEONARDO	96 > 96	•

**ATALA**

50	HACKER AT 12	96 >	•
----	--------------	------	---

**BENELLI**

50	491 ARMY	97 >	• •
50	491 GT	97 >	•
50	491 NAKED	99 >	•
50	491 RACING	97 >	• •
50	491 RR, GP	00 >	• •
50	491 SPORT	97 >	•
50	491 ST	01 >	•
50	491 SUPERBIKE	97 >	• •
50	CHRONO	94 >	•
50	K2	98 >	• •

50	K2 NAMUR	99 >	• •
50	NAKED	94 >	•
50	NEMO	94 >	•
50	PEPE	99 >	•
50	PEPE 4T	05 >	•
50	PEPE CLASSIC	05 >	•
50	QUADRA	94 >	•
100	NAKED	02 >	•
100	PEPE	99 >	•
125	BORN IN HELL	98 >	•
125	VELVET	99 > 04	•
125	VELVET TOURING	01 >	•
150	VELVET	00 > 04	•
150	VELVET TOURING	01 >	•
250	VELVET	99 >	•
250	VELVET TOURING	01 >	•
400	VELVET DUSK	03 >	•

**BETA**

50	ARK	96 > 98	•
50	ARK	99 >	• •
50	EIKON	99 > 03	• •
50	EIKON	04 >	•
50	QUADRA	95 > 96	•
50	TEMPO	99 >	•
50	TEMPO "13"	00 >	•
50	TEMPO "16"	00 >	•
125	EIKON	00 > 03	•
150	EIKON	04 >	•

**BS VILLA**

50	AX	93 >	•
50	GZ	93 >	•

**CAGIVA**

125	CUCCILOLO	98 > 99	•
-----	-----------	---------	---

**DERBI**

50	VAMOS (BREMBO CAL.)	95 > 97	•
----	---------------------	---------	---

**GARELLI**

50	FLO'	00 >	•
----	------	------	---

125	PANTHER	02 >	•
150	PANTHER	02 >	•
250	PANTHER	02 >	•

**GILERA**

50	DNA	01 >	•
50	DT STALKER	97 >	•
50	EAGLET	97 >	•
50	EASY MOVING	96 >	•
50	ICE	02 >	•
50	NRG	94 >	•
50	RUNNER	96 > 05	•
50	RUNNER DD	96 > 05	•
50	RUNNER RACING		
50	REPLICA	03 > 05	•
50	STALKER	97 >	•
50	STORM	96 >	•
50	TYPHOON	93 > 95	•
70	RUNNER	98 >	•
80	TYPHOON	95 >	•
125	DNA	01 >	•
125	TYPHOON XR	95 >	•
180	DNA	01 >	•
200	STALKER	97 >	•
250	STALKER	97 >	•

**HERCULES**

50	GIPSY	95 >	•
----	-------	------	---

**HONDA**

50	FORMULA	94 >	•
50	SFX	96 >	•
50	SH	00 >	•
50	SH FIFTY	95 >	•
50	SKY	96 >	•
50	SKY CLASSIC	00 >	•
50	SKY VETRO	00 >	•
50	SXR	98 >	•

**HYOSUNG**

125	EXCEED	02 >	•
125	GPS D	00 >	•



125	GRAN PRIX PLUS	98 > 01	•
125	HYPER	99 >	•
150	EXCEED	02 >	•
150	GRAN PRIX PLUS	98 >	•

**ITALJET**

50	FORMULA	94 >	•
80	FORMULA	94 >	•
125	FORMULA	94 >	•

**KEEWAY**

50	ARN	08 >	•
50	GOCCIA	08 >	•
50	HACKER	08 >	•
125	ARN	06 >	•
125	HACKER	08 >	•
150	ARN	06 >	•
150	HACKER	08 >	•

**MALAGUTI**

50	CENTRO SL	93 >	•
50	CIAK	02 >	• •
50	CIAK ELECTRONIC POWER	03 >	•
50	CIAK MASTER	06 >	•
50	CROSSER	97 >	•
50	F10	94 >	•
50	F10 TIMEMACHINE	03 >	•
50	F10 WAP	02 >	•
50	F12 PHANTOM	98 > 99	•
50	F12 PHANTOM DIGIT	00 >	•
50	F12 PHANTOM DUCATI CAPIREX	04 >	• •
50	F12 PHANTOM FOGGY	00 >	• •
50	F12 PHANTOM GP	04 >	• •
50	F12 PHANTOM SPECTRUM	00 >	• •
50	F12 RACING LIFE	03 >	• •
50	F12 TYRE TRACK	03 >	• •
50	F15 FIRE FOX FUN	03 >	• •
50	F15 FIREFOX BLUE RACE	05 >	• •
50	F15 FIREFOX DUCATI SBK	04 >	• •

50	F15 FIREFOX MECHATRONIC	03 >	• •
50	F15 FIREFOX RED RACE	05 >	• •
50	F15 FIREFOX TDS	99 >	• •
50	FIREFOX	05 >	• •
50	YESTERDAY	97 >	•
100	CIAK	99 >	• •
100	F 12 PHANTOM TWIN DISK	02 >	• •
100	F12 PHANTOM	00 > 01	•
125	F18 PROJECT	00 >	•
125	F18 WARRIOR	00 >	•
150	F18 PROJECT	00 >	•
150	F18 WARRIOR	00 >	•

**MBK**

50	BOOSTER ALL MODEL	96 > 99	•
50	BOOSTER NAKED	04 >	•
50	BOOSTER R	93 > 95	•
50	BOOSTER SPIRIT	00 >	•
50	FLIPPER	98 >	•
50	MACH	02 >	•
50	NEO'S	94 >	•
50	NITRO	97 >	•
100	NITRO	00 >	•
100	OVETTO	00 >	•

**MOTRON**

50	SPIKE-S	98 >	•
50	STING	96 >	•
50	SYNCRO	99 >	•
50	ZR THUNDER	95 >	•

**PEUGEOT**

50	BUXY R (BREMBO CAL.)	94 > 97	•
50	SPEEDAKE (BREMBO CALIPER)	94 > 97	•
50	SPEEDFIGHT (BREMBO CAL.)	96 >	•
50	SQUAB	94 >	•
50	ZENITH LUXE	94 >	•

**PIAGGIO**

50	ENERGY EXTREME DD	99 >	•
50	ENERGY EXTREME DT	99 >	•
50	FREE	97 >	•
50	NRG DD	02 >	•
50	NRG DT	02 >	•
50	NTT	96 >	•

**SIAMOTO**

50	FALCON	97 >	•
50	S CROSS	97 >	•
125	FALCON	97 >	•

**SUZUKI**

50	KATANA LC	97 >	•
50	KATANA RX	98 >	•
50	R7	95 > 97	•
50	RF	95 > 97	•
50	W, WR	00 >	•

**SYM**

125	XS K	11 >	•
-----	------	------	---

**YAMAHA**

50	AEROX	97 > 12	•
50	AEROX REPLICA	97 > 06	•
50	AEROX ROSSI	04 >	•
50	AXIS	95 > 96	•
50	AXIS MOFA	97 >	•
50	BW SPORT R	02 >	•
50	BW'S BUMP	95 >	•
50	BW'S NEXT GENERATION	99 >	•
50	JOG R	02 >	•
50	NEO'S	96 >	•
50	NEO'S 4	09 >	•
50	OVETTO	96 >	•
50	SPY	96 >	•
50	WHY	98 >	•
100	AEROX	00 >	• •
100	NEO'S	00 >	•
125	TEO'S	01 >	•
150	TEO'S	02 >	•



**07003.CC** 39.7 x 49.5 x 7

**07003.34** “ “ “  
GENUINE

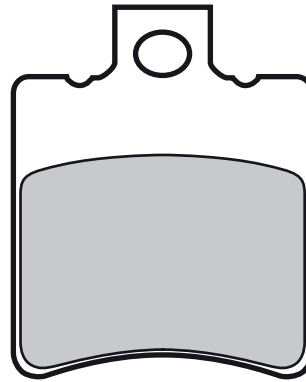

### ANCILLOTTI

80 CROSS 80 > •

### APRILIA

50 AREA 51 98 > • •  
50 AREA 51 SUPERBIKE 00 > 02 • •  
50 COMPAY 09 > 13 •  
50 GULLIVER 96 > 98 •  
50 HABANA 99 > •  
50 HABANA CUSTOM 99 > •  
50 MOJITO 03 > 10 •  
50 MOJITO CUSTOM 03 > 10 •  
50 MOJITO RETRO 03 > 03 •  
50 SCARABEO 98 > 01 •  
50 VIPER-REPLICA 94 > •  
125 LEONARDO 97 > 98 •  
150 LEONARDO 97 > 98 •

### BENELLI

100 K2 99 > •  
125 ADIVA 00 > •  
150 ADIVA 00 > •

### FANTIC MOTOR

50 CABALLERO RC 90 > •  
50 CABALLERO RS 90 > •

### GILERA

50 RUNNER PURE JET 98 > 05 •  
50 RUNNER SP 98 > 05 •

### HONDA

50 X8R S/X 98 > •  
100 SH FIFTY 96 > •

### MACAL

50 FLASH 99 > •

### MALAGUTI

125 CIAK 00 > •  
125 CIAK MASTER 00 > •  
150 CIAK 00 > •  
150 CIAK MASTER 00 > •

### MBK

125 DOODO 00 > •  
150 DOODO 01 > •

### PEUGEOT

125 ENDURO 84 > •

### PIAGGIO

50 NRG ALL MODEL 95 > 97 •  
50 NRG DD 02 > •  
50 NRG EXTREME 01 > •  
50 NRG POWER DD 05 > • •  
50 NRG PUREJET 05 > • •  
50 STORM 94 > 95 •  
50 TYPHOON 94 > 95 •  
50 TYPHOON CATALYZED 02 > • •  
50 VESPA LXV 08 > •  
50 VESPA S COLLEGE 4T 11 > •  
50 ZIP FAST RIDER 93 > 95 •  
100 FREE 02 > •  
125 HEXAGON 94 > 97 •  
125 TYPHOON CATALIZ. 02 > • •  
125 VESPA LXV 08 > •  
150 HEXAGON 94 > 97 •

### YAMAHA

125 TEO'S 99 > 00 •



**07004.CC** 50.2 x 53.2 x 7.8

**07004.18**  
GENUINE “ “ “

**07004.30**  
GENUINE “ “ “

**07004.35**  
GENUINE “ “ “

**07004.65**  
GENUINE “ “ “

**07004.XS** “ “ “

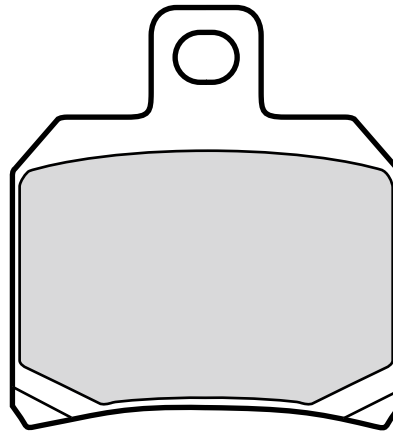

### ADIVA

250 AD 200 06 > • •

### APRILIA

50 RS 06 > •

### DERBI

50 GP1 05 > •

250 GP1 05 > •

### GILERA

500 NEXSUS (EURO 3) 06 > •

500 NEXSUS SP (EURO 3) 06 > •

500 NEXUS 03 > 05 •

### MALAGUTI

125 MADISON 99 > •

125 MADISON 3 08 > •

250 MADISON 99 > •

500 SPIDER MAX GT 04 > •

500 SPIDER MAX RS 09 > •

500 SPIDERMAX 04 > •

### MBK

125 SKYCRUISER 06 > •

125 SKYLINER 02 > •

125 THUNDER 01 > •

150 SKYLINER 01 > •

150 THUNDER 02 > •

180 SKYLINER 04 > •

### PEUGEOT

50 SPEEDFIGHT 3 LC,  
LC RS 10 > •

50 SPEEDFIGHT TOTAL  
SPORT 16 > •

125 ACTIVE 13 > •

125 CITYSTAR 11 > •

200 CITYSTAR 13 > •

### PIAGGIO

125 X8 04 > 04 •

125 X9 00 > 02 • •

125 X9 03 > •

125 X9 right caliper 04 > 05 •

180 X9 00 > 02 • •

180 X9 AMALFI 00 > 02 • •

200 X8 04 > •

200 X9 03 > • •

200 X9 EVOLUTION 03 > 04 • •

250 X9 00 > 02 • •

250 X9 03 > •

500 BEVERLY 02 > 04 • •

500 BEVERLY 05 > •

500 BEVERLY CRUISER 08 > • •

500 BV 06 > • •

500 X9 00 > 02 • •

500 X9 EVOLUTION 04 > •

500 X9 EVOLUTION ABS 04 > •

### RIEJU

50 MRT PRO, PRO  
SUPERMOTARD 09 > • •

50 TANGO 08 > •

### SUZUKI

125 BURGMAN 01 > 06 •

150 BURGMAN 04 > •

### YAMAHA

125 MAJESTY 01 > •

125 MAXSTER 01 > •

125 X CITY 08 > •

125 X MAX 06 > 09 •

125 X MAX 10 > •

125 X MAX SPORT EDITION 11 > •

150 MAJESTY 01 > •

150 MAXSTER 01 > •

180 MAJESTY 04 > •

**07005.CC**

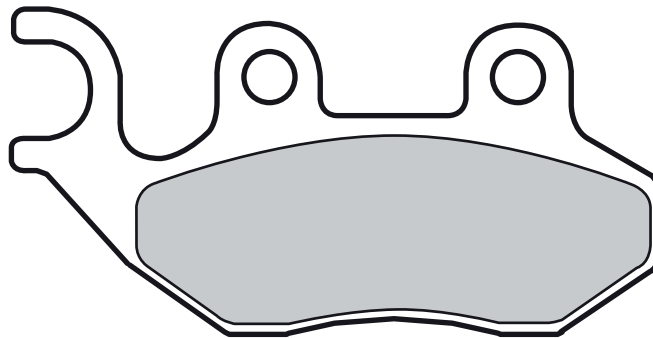
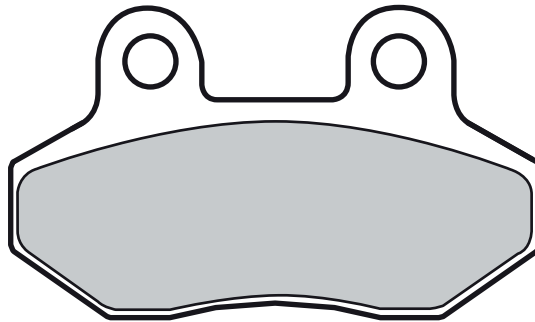
 69.8 x 41 x 8.2  
 85.1 x 42.9 x 8.2

**CAGIVA**

50	CITY LUCKY	95 >	•
125	PASSING	95 >	•

**GARELLI**

50	KRS	02 >	•
50	SPORT PMX	00 >	•
125	FREELAND	02 >	•
125	T-TEX	00 >	•
150	FREELAND	02 >	•

**PEUGEOT**

50	TWEET	10 > 12	•
50	TWEET PARIS	16 >	•
50	TWEET RS	10 > 12	•
125	LXR	10 >	•
125	TWEET	10 > 12	•
125	TWEET PARIS	16 >	•
125	TWEET RS	10 > 12	•
150	TWEET	10 > 12	•
150	TWEET PARIS	16 >	•
150	TWEET RS	10 > 12	•
200	LXR	10 >	•

**PGO**

50	DR.BIG	01 >	•
50	G-MAX	06 >	•
50	I DEP	09 >	•
50	LIBRA	10 >	•
50	LIGERO	06 >	•
50	PMX	01 >	•
50	SPORT	01 >	•
50	T-REX	99 >	•
100	LIGERO	06 >	•
100	MY BUBU	02 >	•
110	T-REX	99 >	•
125	CHARGE	02 > 02	•
125	LIBRA	10 >	•
125	LIGERO	06 >	•
125	MY BUBU	02 >	•
125	T-REX	99 >	•
125	X-HOT	10 >	•
150	T-REX	01 >	•
150	TR 3	02 >	•

**SANYANG**

50	JET	95 > 98	•
50	JUNGLE	96 >	•
50	RED DEVIL	97 >	•

50	SUPER FANCY	95 > 97	•
100	PARTY	97 >	•
100	SUPER FANCY	95 >	•
125	ATTILA	95 >	•
125	SUPER DUKE	95 >	•
150	SUPER DUKE	96 >	•

**SYM**

50	ALLO	11 >	•
50	CROX	14 >	•
50	FIDDLE	09 >	•
50	JET	95 >	•
50	JET 4 NAKED, R	11 >	•
50	JET BASIX	07 >	•
50	JET EURO X	05 >	•
50	JET SPORT X	06 >	•
50	JUNGLE	96 >	•
50	MASK	00 >	•
50	MASK LC	00 >	•
50	ORBIT	12 >	•
50	RED DEVIL	97 >	•
50	SUPER FANCY	95 > 97	•
50	SYMPHONY	09 >	•
50	SYMPHONY SR	11 >	•
50	SYMPLY	08 >	•

50	X'PRO	14 > •		125	FIDDLE	09 > •		150	FIDDLE II	11 > •
100	JET	00 > •		125	GTS	07 > •		150	SUPER DUKE	96 > 01 •
100	JET EURO X	05 > •		125	HD EVO DT	10 > •		150	SYMPHONY	10 > •
100	JET SPORT X	06 > •		125	JET 4	11 > •		150	SYMPHONY SR	11 > •
100	PARTY	97 > •		125	MEGALO	02 > •		200	FIDDLE II	11 > •
100	SUPER FANCY	95 > •		125	NEW DUKE	02 > 07 •		200	HD EVO	07 > •
110	STAR	03 > •		125	SUPER DUKE	95 > 01 •		300	CITYCOM	09 > • •
125	ALLO	11 > •		125	SYMPHONY	09 > •		<b>TGB</b>		
125	ATTILA	00 > •		125	SYMPHONY SR	11 > •		50	AKROS TEC.	94 > •
125	CITYCOM	09 > •		125	SYMPLY	08 > •				
125	CROX	14 > •		125	X'PRO	14 > •				
125	EVO	14 > •		150	ATTILA	00 > •				



**07006.CC** 78.9 x 46.9 x 7.3

**07006.XS** “ “ “

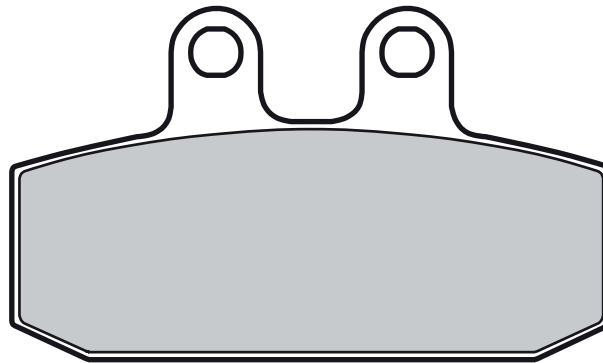

### APRILIA

50	SR MOTARD	12 >	•
125	RX	86 > 89	•
125	SCARABEO	99 > 03	•
125	SPORTCITY	05 >	•
125	SR MOTARD	12 >	•
125	TUAREG RALLY	86 > 88	•
150	SCARABEO	99 >	•
200	SCARABEO	02 > 06	•
200	SCARABEO GT	01 >	•
200	SPORTCITY	05 >	•
250	LEONARDO	99 >	•
250	SPORTCITY	06 >	•
250	TUAREG RALLY	86 >	•
300	LEONARDO ST	05 >	•
300	SPORTCITY CUBE	08 >	•
350	ETX	86 >	•
350	TUAREG WIND	87 > 87	•
400	SCARABEO I.E.	06 >	•

500	ATLANTIC	02 > 05	•
500	SCARABEO CLASSIC	10 >	•
500	SCARABEO GT ABS right caliper	06 >	•
500	SCARABEO ie right caliper	06 >	•
500	SCARABEO right caliper	04 > 05	•
600	TUAREG	86 > 87	•

### CAGIVA

50	BLUES	89 >	•
125	BLUES	89 > 93	•

### DERBI

125	RAMBLA	10 >	•
250	RAMBLA	10 >	•
300	RAMBLA	08 >	•
300	RAMBLA	10 >	•

### GILERA

125	ARIZONA HAWK	85 >	•
125	RC	90 >	•
125	RUNNER	97 >	•
125	X1	89 > 89	•
200	FAST BIKE	88 >	•
200	RTX	85 >	•

### HONDA

125	NSR, F	88 > 89	•
-----	--------	---------	---

### MALAGUTI

125	RUNNER	87 >	•
500	SPIDERMAX	04 >	•

### MOTO MORINI

501	CAMEL	85 > 86	•
501	EXCALIBUR	87 > 88	•



**07007.CC** 78.9 x 46.9 x 7.5

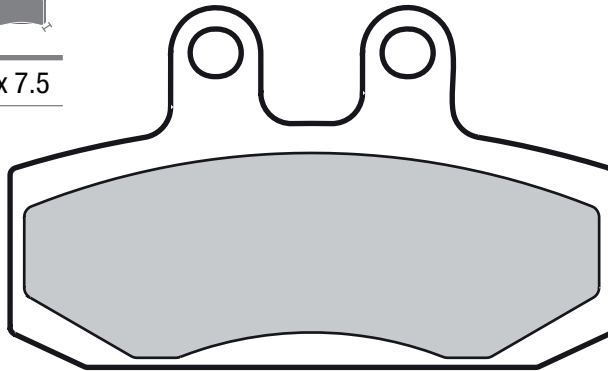

### CIMATTI

125 ROADSTER 94 > •

### HONDA

50 SJ BALI 96 > 98 •  
100 SJ BALI 95 > •

### PEUGEOT

50 ELYSEO 02 > •  
100 ELYSEO 96 > •  
125 ELYSEO 98 > 99 •



**07008.CC** 31.4 x 51.9 x 5.5

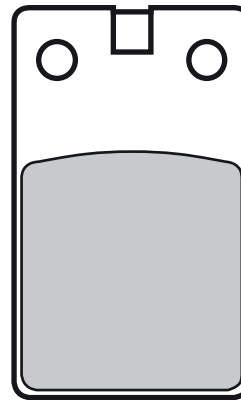

### APRILIA

50 AF-1 86 > •  
50 RED ROSE 88 > 89 •  
125 TX 86 > •

### BETA

50 AE 88 > •  
50 ALP 90 > •  
50 RV VRS 88 > •  
125 TR32 86 > 87 •  
125 TR33 86 > 87 •  
125 TR34 88 > •  
240 TR33 86 > •  
260 SYNT 92 > •

### FANTIC MOTOR

50 TRIAL 87 > 88 •  
125 STRADA HP1 85 > •

125 TRIAL 86 > •  
201 TRIAL 85 > •  
241 TRIAL 87 > • •  
243 TRIAL 87 > • •  
301 TRIAL 85 > •  
303 TRIAL 87 > • •  
343 TRIAL 87 > • •

### GILERA

50 BULLIT 90 > •

### KEEWAY

125 SPEED 06 > •  
150 SPEED 06 > •

### MALAGUTI

50 CH 86 > •  
50 CROSSER 95 > 96 •

50 ENDURO DUNE 87 > 88 • •  
50 F12 PHANTOM 94 > 97 •  
50 F15 FIRE FOX 96 > •  
50 FIFTY MISTRAL 90 > •  
50 RST SPORT 97 > • • •  
450 RONCO MGX 87 > •

### MONTESA

360 ENDURO 86 > •

### RIEJU

50 DRAG 92 > •

### TRESOLDI

80 CR 85 > •

### ZÜNDAPP

80 KS TOURING LK 81 > •



**07009.CC**

31.6 x 57.2 x 5.5

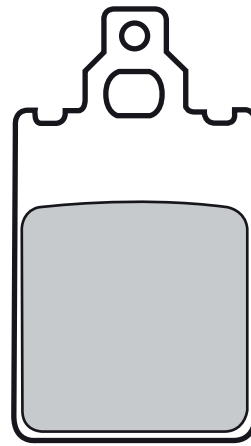
**APRILIA**

50	AF-1 EUROPA	90 >	•
50	AF-1 FUTURA	90 >	•
50	ET TUAREG	86 >	•
50	RED ROSE	90 > 91	•
50	RED ROSE CLASSIC	92 >	•
50	RX	90 > 91	•
50	TUAREG	86 >	•
50	TUAREG RALLY	90 >	•
240	CLIMBER	89 > 90	•
275	CLIMBER	89 > 90	•

**ATALA**

50	CAROSSELLO AT 15	97 >	•
----	------------------	------	---

**BENELLI**

50	CHRONO	92 > 93	•
----	--------	---------	---

**BETA**

50	ALP	90 >	•
50	CHRONO "13"	94 >	•
50	MX ENDURO	92 >	•
125	TR34	88 >	•

**DERBI**

75	GPR	89 >	•
----	-----	------	---

**FANTIC MOTOR**

50	FAST	90 >	•
50	OASIS	90 >	•
75	OASIS	89 >	•

**GARELLI**

50	SAHEL	91 >	•
----	-------	------	---

**KTM**

50	GO	94 >	•
----	----	------	---

**MALAGUTI**

50	CIAK	99 > 01	•
50	F12 PHANTOM	98 > 99	•
50	F12 PHANTOM DIGIT	00 >	•
50	F12 PHANTOM LC	94 >	•
50	F15 FIREFOX L.C.	96 >	•
50	MDX ENDURO	87 >	•
50	MLX	87 >	•
50	SILVERFOX	96 >	•

**YAMAHA**

50	DTR	98 >	•
----	-----	------	---



**07010.CC** 74.9 x 36.1 x 7.5

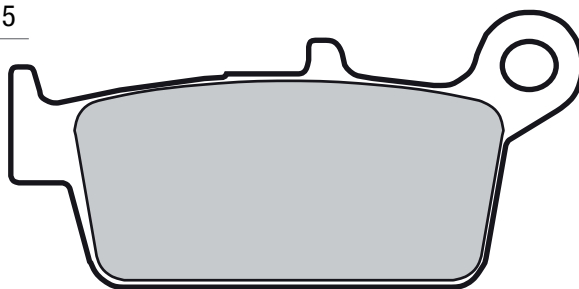

### HONDA

75 YUPY	90 >	•
90 YUPY	90 > 94	•

### KYMCO

50 CX SUPER	94 >	•
50 FEVER ZX	96 >	•
50 HEROISM	95 > 96	•
50 K12	95 >	•

50 KB	95 >	•
50 SCOUT	95 >	•
50 SNIPER-DD	94 >	•
50 TOP BOY	99 >	•
100 KB	99 >	•
100 TOP BOY	99 >	•
150 FREEWAY	95 >	•

### PEUGEOT

50 SV GEO	92 >	•
80 SV	91 > 92	•
125 EXECUTIVE	94 >	•
125 SV GEO	92 >	•

### SIAMOTO

50 KD	00 >	•
125 KD	00 >	•



**07011.CC** 74.9 x 36.1 x 9

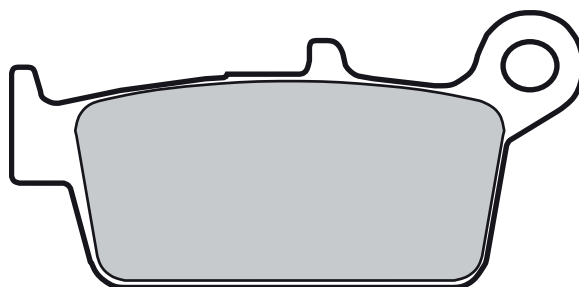

### DAELIM

50 BESBI	07 >	•
----------	------	---

### HONDA

50 CRM	89 > 92	•
50 CRM	93 > 96	•
50 NH	94 >	•
80 MBX FWD	83 >	•
80 NSR R	93 >	•
150 NS	92 >	•

### ITALJET

125 AMARCORD	08 >	•
--------------	------	---

### KYMCO

50 COBRA CROSS	01 >	•
50 COBRA EXCLUSIVE	01 >	•
50 COBRA RACER	01 >	•
50 CURIO CX	96 >	•
50 EASY	01 >	•
50 FILLY	01 > 01	•
50 VITALITY 4-STROKE	04 >	•
50 YUP	00 >	•

### MOTOR UNION

125 JC	98 >	•
--------	------	---

### PEUGEOT

50 SV GEO	93 >	•
50 SV L	93 >	•
80 SV	93 > 95	•
125 SV C EXECUTIVE	96 >	•
125 SV EXECUTIVE	94 >	•
125 SV GEO	93 >	•

### SIAMOTO

125 COLUMBUS	00 >	•
--------------	------	---



**07012.CC** 76.5 x 41.9 x 7.3  
94.4 x 42.1 x 7.3

**07012.XS** “ “ “

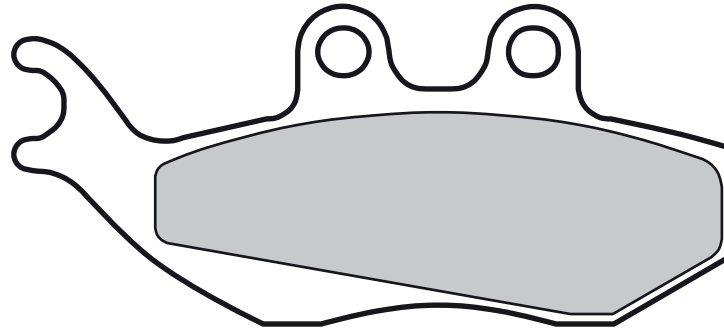
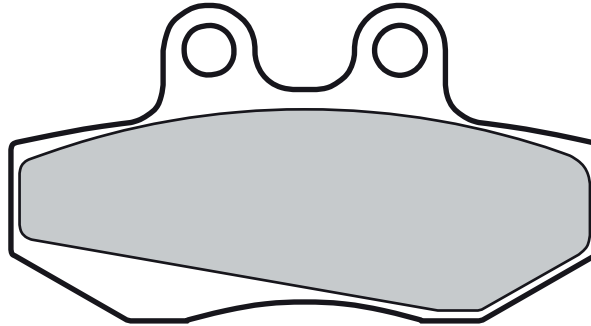

### APRILIA

50	MX	03 >	•
50	PEGASO	70 >	•
50	RS EXTREMA	00 >	•
50	RS REPLICA	00 >	•
50	RS REPLICA	03 > 05	•
50	RX	92 > 05	•
50	RX RACING	04 > 07	•
125	ETX	99 >	•
125	PEGASO	92 >	•
125	RX	92 > 92	•

### BENELLI

400	VELVET DUSK	03 >	•
-----	-------------	------	---

### BETA

50	RR	04 >	•
50	RR ENDURO	04 > 09	•
50	RR SUPERMOTARD ALU	04 >	•

### GILERA

50	DNA	01 >	•
125	DNA	01 >	•
125	RUNNER FX (GRIMECA CALIPER)	00 >	•

125	RUNNER FX SP (GRIMECA CALIPER)	00 >	•
125	RUNNER VX 4T (GRIMECA CALIPER)	01 >	•
180	DNA	01 >	•
180	RUNNER FXR	98 >	•
180	RUNNER FXR (GRIMECA CALIPER)	00 >	•
180	RUNNER FXR SP (GRIMECA CALIPER)	00 >	•
180	RUNNER SP	99 >	•
200	RUNNER FX SP	98 >	•
200	RUNNER VXR	02 >	•

### HM

50	CRE BAJA RR	07 > 09	•
50	CRE SIX COMPETITION	07 > 08	•

### HONDA

50	SJ BALI	94 > 95	•
----	---------	---------	---

### MALAGUTI

50	XSM	03 >	•
125	MADISON	99 >	•
150	MADISON	99 >	•
180	MADISON	02 >	•

200	MADISON	03 >	•
200	MADISON BLACK RIDER	03 >	•

### PIAGGIO

125	HEXAGON	98 >	•
125	HEXAGON GTX	00 >	•
125	HEXAGON LX	98 > 99	•
125	SKIPPER	96 > 98	•
125	SKIPPER LX	99 >	•
125	SUPERHEXAGON	01 >	•
150	HEXAGON	98 >	•
150	SKIPPER	94 > 97	•
150	SKIPPER LXT-ST	99 >	•
150	SUPERHEXAGON	99 > 00	•
150	SUPERHEXAGON	01 >	•
180	HEXAGON	94 >	•
180	SUPER HEXAGON GTX 12"	01 > 03	•
180	SUPERHEXAGON	99 > 00	•
180	SUPERHEXAGON	01 >	•
250	HEXAGON	98 >	•
250	SUPERHEXAGON	99 > 01	•

### RIEJU

50	RS1	01 >	•
50	RS1 CASTROL	01 >	•



**07013.CC** 31.6 x 51.1 x 5.5

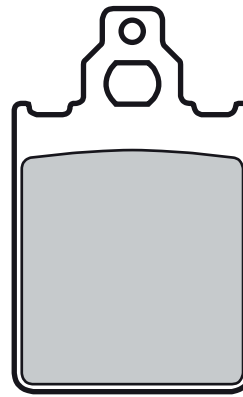

### CAGIVA

50	PRIMA	93 >	•
80	PRIMA	92 >	•
125	PRIMA	92 >	•

### ITALJET

50	FORMULA	94 >	•
80	FORMULA	94 >	•
125	DRAGSTER	97 >	• •
125	FORMULA	94 >	•
180	DRAGSTER	99 >	• •

### LML

125	STAR 2T	10 >	•
125	STAR DELUXE	01 > 03	•
125	STAR I 4T	10 >	•
150	STAR 2T	10 >	•
150	STAR DELUXE	01 > 03	•
150	STAR I 4T	10 >	•
151	STAR I 4T	10 >	•
200	STAR I 4T	10 >	•



### PIAGGIO

50	QUARTZ	95 >	•
50	SKIPPER	92 >	•
75	SFERA	96 > 97	•
80	SKIPPER	93 > 95	•
125	SKIPPER	93 > 95	•
125	VESPA PX	96 > 01	•
150	VESPA PX	96 > 01	•
150	VESPA PX	08 >	•
200	VESPA PX	96 > 01	•

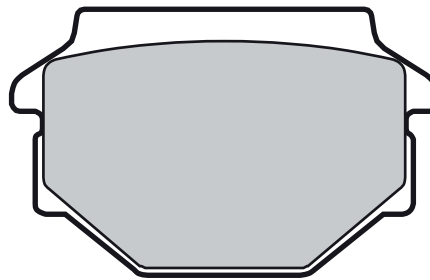
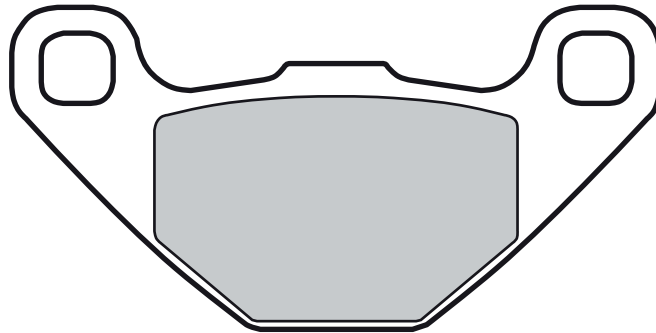

**07014.CC**

 84.9 x 42.4 x 7.5  
 55.8 x 34.9 x 9.7

**APRILIA**

125 RX 92 &gt; •

**FANTIC MOTOR**

 50 BIG WHEEL 93 > •  
 50 GRINTA 95 > •  
 50 LEADER 95 > •

**MZ**

 660 BAGHIRA MUZ 96 > •  
 660 BLACK PANTHER MUZ 00 > •

 660 MASTIFF MUZ 00 > •  
 660 STREET MOTO MUZ 00 > •

**PEUGEOT**

50 SV ROLAND GARROS 93 &gt; •

**SACHS**

 125 ROADSTER 01 > •  
 125 X-ROAD 4T 05 > •  
 125 XTC 99 > •  
 125 XTC N 99 > •

 125 ZX 99 > •  
 125 ZZ 99 > •  
 500 MADASS 05 > •  
 650 ROADSTER 01 > •  
 800 ROADSTER 00 > •

**SIMSON**

125 RS 01 &gt; •

**SYM**

125 HUSKY 96 &gt; 98 •

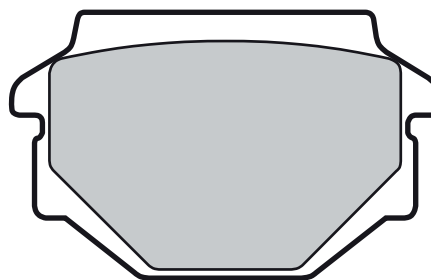
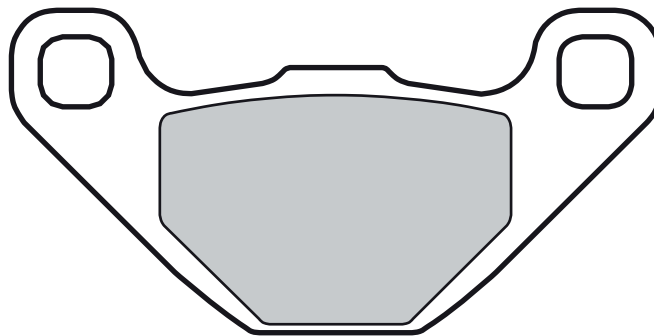

**07015.CC**

 84.9 x 42.4 x 6.5  
 55.8 x 34.9 x 8.7

**APRILIA**

125	MX supermotard	04 >	•
125	MX supermoto	07 >	•
125	PEGASO	92 >	•
125	RX	90 > 90	•
125	SX	08 >	•
125	TUAREG RALLY	90 > 91	•
125	TUAREG RALLY	92 >	•
600	PEGASO	90 >	•

**CAGIVA**

50	WMX	89 >	•
----	-----	------	---

**GILERA**

50	RC TOP RALLY	89 >	• •
125	SUPERMOTARD	04 >	•

**HERCULES**

	SUPRA GP	80 >	•
--	----------	------	---

**KYMCO**

125	AGILITY CITY	11 >	•
-----	--------------	------	---

**MALAGUTI**

50	F10	92 > 93	•
50	MEX	86 >	•

**PEUGEOT**

50	SV SPORT	93 >	•
----	----------	------	---





**07016.CC** 58.8 x 44.5 x 9.5

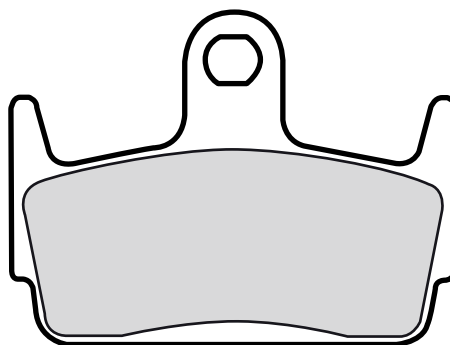

### HONDA

50	X8R S/X	98 >	•
80	CR	03 >	•



### KYMCO

50	SNIPER-DD	94 >	•
125	HEROISM	96 >	•
150	HEROISM	96 >	•



### SYM

100	JET SPORT X	06 >	•
-----	-------------	------	---



**07017.CC** 31.5 x 49 x 7

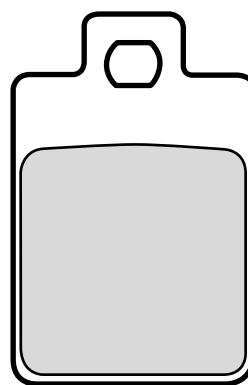

### GILERA

50	TYPHOON BENETTON	96 >	•
50	TYPHOON MARTINI	96 >	•



### PIAGGIO

50	FREE	93 > 96	•
50	NRG	98 >	•
50	SFERA RST	96 > 98	•



50	STORM	96 >	•
50	TYPHOON	96 > 01	•
80	SKIPPER	96 >	•
80	TYPHOON	96 >	•
125	TYPHOON	96 >	•



**07018.CC** 59.6 x 43.7 x 9.1

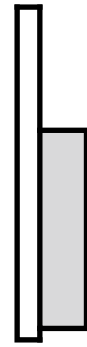
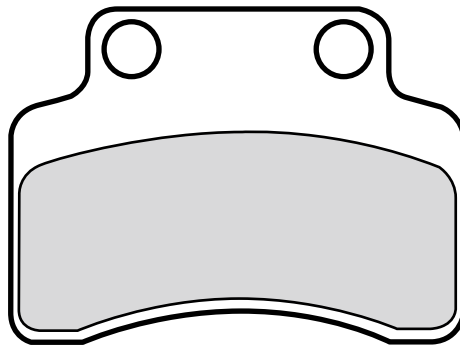

### BENELLI

50	49 X	08 >	•
50	QUATTRO NOVE X	08 >	•

### CAGIVA

50	NAG	08 >	•
125	BRILLO	08 >	•

### GARELLI

50	FLEXI	12 >	•
50	GSP	09 >	•
50	XO	12 >	•
50	XO' I	08 > 09	•
50	XO' I	10 > 11	• •

### ITALJET

50	SX1	08 >	•
----	-----	------	---

### KEEWAY

50	F-NKD	10 >	•
50	FLASH ELECTRIC	10 >	•
50	FOCUS	06 >	•
50	MATRIX	06 >	•
50	MATRIX ELECTRIC	10 >	•
50	MATRIX RACING SPORT	10 >	•
50	RY 8	07 > 09	•
50	RY 8	10 >	•
125	FOCUS	06 >	•
125	MATRIX	06 >	•
125	MATRIX RACING SPORT	10 >	•
150	FOCUS	06 >	•
150	MATRIX	06 >	•
150	MATRIX RACING SPORT	10 >	•

### KYMCO

50	CALYPSO	97 >	•
----	---------	------	---



50	HEROISM	97 >	•
125	CALYPSO	99 >	•
125	HEROISM	96 >	•
150	HEROISM	96 >	•

### PEUGEOT

50	SV GEO EXECUTIVE	96 >	•
50	VIVACITY	08 >	•
50	VIVACITY SPORTLINE	11 >	•
80	SV	96 >	•

### TGB

50	EXPRESS	09 >	•
50	GT	09 >	•
125	EXPRESS	09 >	•





<b>07019.CC</b>	35.3 x 48.8 x 6.9
<b>07019.XS</b>	“ “ “

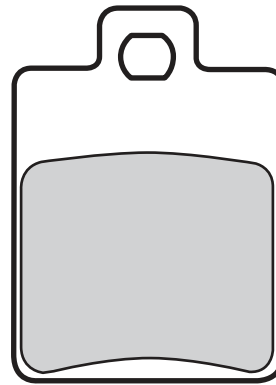

### DERBI

50	SONAR	10 >	•
125	SONAR 4-STROKE	10 >	•
150	SONAR 4-STROKE	10 >	•

### GILERA

180	RUNNER FXR	98 >	•
180	RUNNER SP	99 >	•
180	RUNNER VXR	01 >	•
180	RUNNER VXR 4T (HENGTONG CALIPER)	00 >	•

200	RUNNER VXR	02 >	•
200	RUNNER VXR 4T (HENGTONG CALIPER)	01 >	•
250	STALKER	97 >	•

### PIAGGIO

50	ENERGY EXTREME DD	99 >	•
50	LIBERTY S 2-STROKE, 4-STROKE	06 >	•
50	VESPA S 2T	07 >	•
50	VESPA S 4T-4V	09 >	•

50	ZIP	96 >	•
50	ZIP 4T	00 >	•
50	ZIP CATALYZED	00 >	•
50	ZIP II	01 >	•
50	ZIP SPORT RST	96 > 97	•
125	LIBERTY S	06 >	•
125	MP3	09 >	•
125	MP3 HYBRID	10 >	•
125	MP3 IE	09 > 09	•
150	VESPA LX	08 >	•
300	MP3 LT I.E.	10 >	•
500	MP3 SPORT	10 >	•



<b>07020.CC</b>	50.6 x 53.4 x 9.4
<b>07020.XS</b>	“ “ “

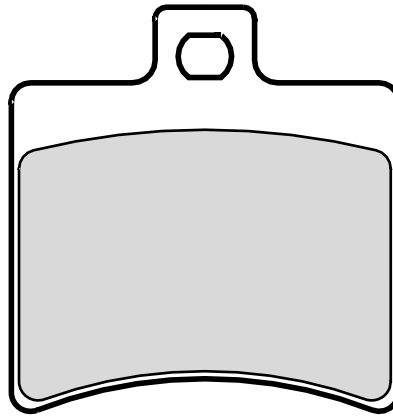

### APRILIA

50	SCARABEO DITECH	02 >	•
50	SR DITECH	00 >	•
50	SR R	05 >	•
50	SR R FACTORY	05 >	•
50	SR R FACTORY REPLICA SBK	10 >	•
50	SR STREET	05 >	•
125	ATLANTIC	03 >	•
125	RS	06 >	•
125	SCARABEO	99 > 03	•
125	SCARABEO GT	04 >	•
125	SCARABEO I.E.	08 >	•
125	SPORTCITY	05 >	•
150	SCARABEO	99 >	•
150	SCARABEO GT	04 >	•
200	ATLANTIC	03 >	•
200	SCARABEO	02 > 06	•
200	SCARABEO	07 >	•
200	SCARABEO CLASSIC	10 >	•
200	SCARABEO GT	01 >	•
200	SCARABEO I.E.	12 >	•
200	SPORTCITY	05 >	•

250	ATLANTIC	04 >	•
250	LEONARDO	99 >	•
250	SCARABEO	04 > 05	•
250	SCARABEO I.E.	06 >	•
250	SPORTCITY	06 >	•
300	ATLANTIC	10 >	•
300	LEONARDO ST	05 >	•
300	SCARABEO SPECIAL	10 >	•
300	SPORTCITY CUBE	08 >	•
400	ATLANTIC SPRINT	06 >	•
400	SCARABEO I.E.	06 >	•
500	ATLANTIC	02 > 05	•
500	ATLANTIC SPRINT	06 >	•
500	SCARABEO CLASSIC	10 >	•
500	SCARABEO GT ABS right caliper	06 >	•
500	SCARABEO ie right caliper	06 >	•

### BETA

50	EIKON	04 >	•
125	EIKON	00 > 03	•
150	EIKON	04 >	•

### DERBI

125	RAMBLA	10 >	•
250	RAMBLA	10 >	•
300	RAMBLA	08 >	•
300	RAMBLA	10 >	•

### MALAGUTI

125	F18 PROJECT	00 >	•
125	F18 WARRIOR	00 >	•
125	PHANTOM MAX	04 >	•
150	F18 PROJECT	00 >	•
150	F18 WARRIOR	00 >	•
150	MADISON	99 >	•
180	MADISON	02 >	•
200	MADISON	03 >	•
200	MADISON BLACK RIDER	03 >	•
200	PHANTOM MAX	04 >	•
250	MADISON 3	08 >	•
250	MADISON RS	05 >	•
250	PASSWORD	06 >	•
250	PHANTOM MAX	05 >	•
400	MADISON	02 >	•



<b>07021.CC</b>	53.6 x 50.7 x 7.9
<b>07021.XS</b>	“ “ “

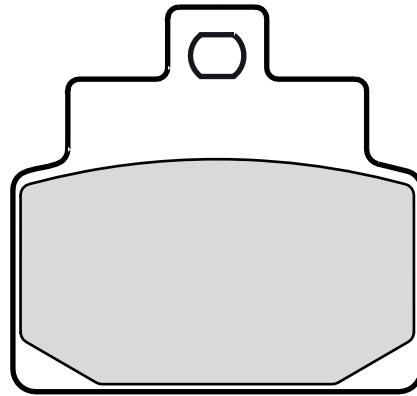

### APRILIA

50	SCARABEO 4T	04 >	•
50	SCARABEO 4T RESTYLING	06 > 08	•
100	SCARABEO	00 >	•

100	SCARABEO 4-STROKE	04 >	•
100	SCARABEO NET	10 >	•
125	HABANA	99 >	•
125	HABANA CUSTOM	00 >	•
125	HABANA DITECH	02 >	•
125	LEONARDO	99 >	• •

125	MOJITO	02 >	•
125	SR	99 >	•
125	SR REPLICA	99 > 01	•
150	LEONARDO	99 >	• •
150	SR	99 >	•
150	SR REPLICA	99 >	•

**07022.CC**

 84.8 x 43 x 8.6  
 64 x 36.7 x 11

**07022.XS**

“ “ “

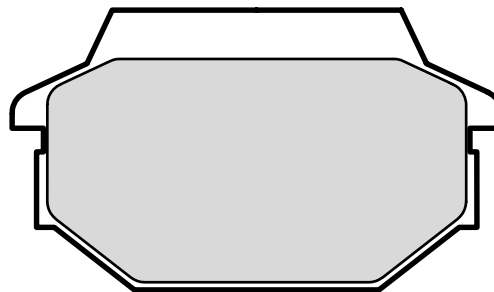
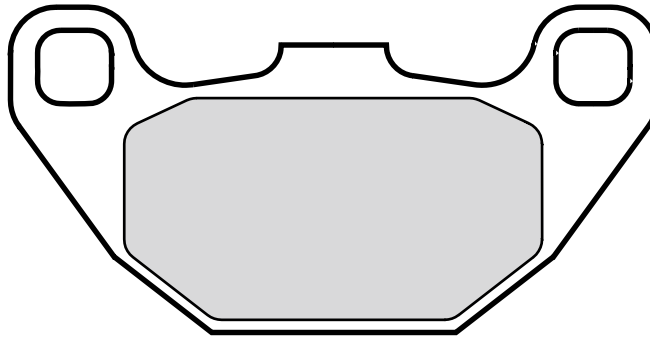
**KYMCO**

50	AGILITY R16	06 >	•
50	LIKE	08 > 09	•
50	MAXXER	03 >	•
50	MXU	05 >	•
50	PEOPLE	99 >	•
50	PEOPLE S	06 >	•
50	PEOPLE S 4-STROKE	06 >	•
50	SUPER 8	08 >	•
50	SUPER 9 L.C.	02 >	•
125	AGILITY 16 PLUS	14 >	•
125	AGILITY R16	08 >	•
125	MAXXER	03 >	•



125	PEOPLE	99 >	•
125	PEOPLE ONE I	14 >	•
125	PEOPLE S	06 >	•
125	SUPER 8	08 >	•
125	SUPER 9	00 >	•
150	AGILITY R16	08 >	•
150	MAXXER	03 >	•
150	MXU	05 >	•
150	PEOPLE	99 >	•
200	AGILITY	11 >	•
200	AGILITY 16 PLUS	14 >	•
200	AGILITY R16	11 >	•
200	PEOPLE S	05 >	•
250	SUPER 9	00 >	•

**LAVERDA**

125	PHOENIX	01 >	•
150	PHOENIX	01 >	•
200	PHOENIX	01 >	•

**SYM**

125	HD	05 >	•
125	JOYRIDE	01 >	•
150	JOYRIDE	01 >	•
200	HD	04 > 06	•
200	JOYRIDE	01 >	•
500	GT	07 >	•



**07023.CC**

105 x 43.8 x 7.9  
65.8 x 36.5 x 12.7

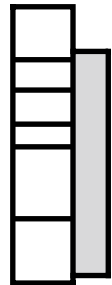
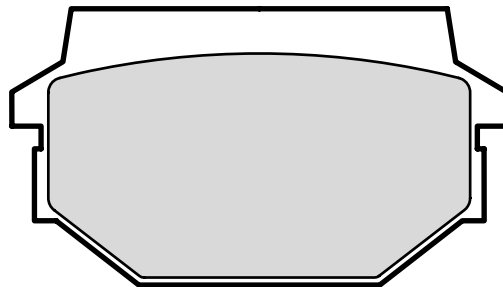
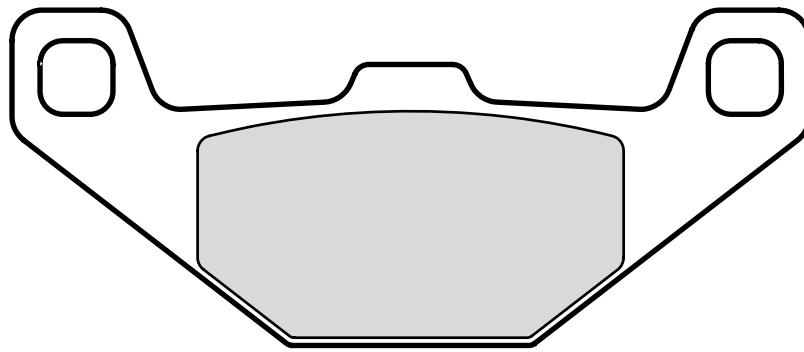

**SYM**

125 HUSKY	99 >	•
150 HUSKY	99 >	•



**07024.CC**

41.1 x 45 x 8

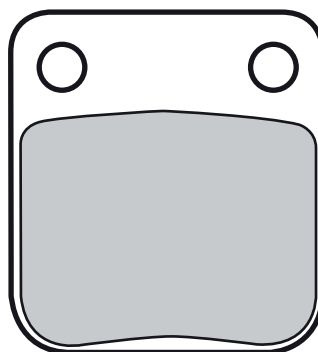
**DAELIM**

50	CORDI	06 >	•
50	DELFINO	99 >	•
50	E-FIVE	03 >	•
50	MESSAGE II	98 >	•
50	S-FIVE	06 >	•
50	TAPO	99 >	•
50	VIVO	99 >	•

100	ALTINO	99 >	•
100	DELFINO	99 >	•
125	ALTINO	02 >	•
125	DLX	01 >	• •
125	HISTORY	01 >	• •
125	MESSAGE II	00 >	•
125	NF	03 >	•
125	NS II	00 >	•
125	OTELLO	99 > 07	•

125	OTELLO	08 >	•
125	S2 FI	07 >	•
125	U3 FI	07 >	•
125	VS	95 > 99	•

**HONDA**

50	SC 01	91 >	•
50	SP	91 >	•

**07025.CC**

89.9 x 49 x 9

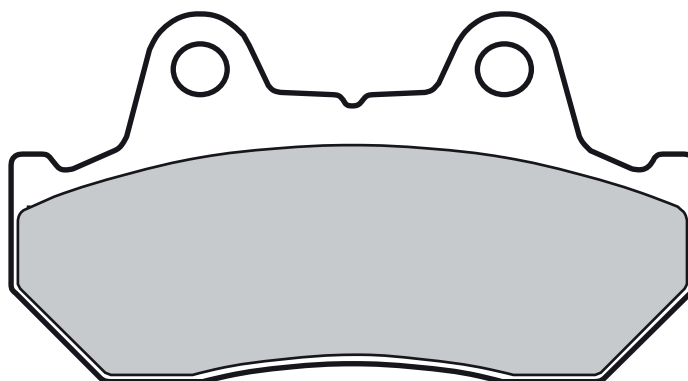
**HONDA**

250	CN	93 >	•
250	CN HELIX	86 > 87	•

250	CN HELIX	92 > 92	•
250	CN SCOOTER	88 > 92	•
250	CN SPAZIO	90 > 92	•

**SYM**

110	BULLET	93 >	•
125	AERO WOLF	70 >	•

**07026.CC**

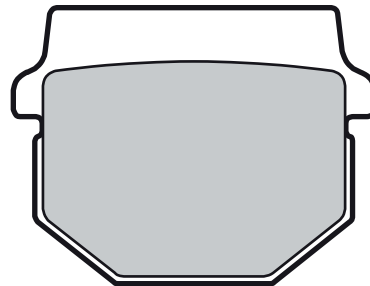
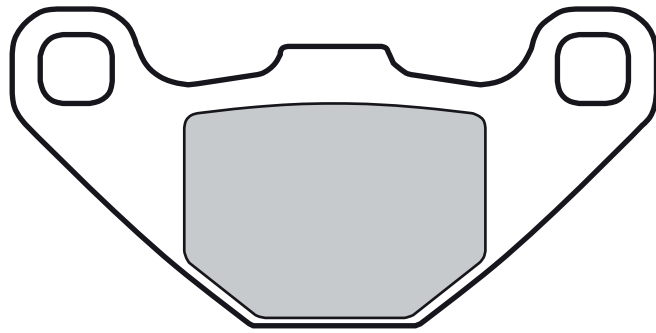
 84.9 x 42.4 x 7.8  
 47.4 x 37 x 10

**ADLY**

50	PANTHER	01 >	•
50	SILVER FOX	06 >	•
50	SUPERSONIC	00 >	•
50	THUNDERBIKE	97 >	•
100	PANTHER	01 >	• •
100	SILVER FOX	06 >	•
100	SUPERSONIC	01 >	• •
100	THUNDERBIKE	01 >	• •
125	SUPERSONIC	01 >	• •
125	THUNDERBIKE	01 >	• •

**AEON**

50	AERO	06 >	•
50	PULSAR	06 >	•
50	REGAL	06 >	•
50	TORCH	06 >	•
90	REGAL	06 >	•
100	PULSAR	06 >	•
110	AERO	06 >	•
110	PULSAR	06 >	•
125	PULSAR	06 >	•
125	URBAN	11 > 13	•
150	PULSAR	06 >	•
200	ELITE	11 >	•
350	URBAN	11 >	•

**APRILIA**

50	SX	14 >	•
----	----	------	---

**FANTIC MOTOR**

50	PONY SR	93 >	•
----	---------	------	---

**GILERA**

50	EAGLET	97 >	•
----	--------	------	---

**HYOSUNG**

50	AVANTI	99 >	•
50	CRUISE	95 >	•
50	PRIMA	98 >	•
50	RUSH	97 >	•
50	SB	00 >	•
50	SD	00 >	•
50	SENSE	98 >	•
50	SF	99 >	•
50	SUPER CAB	98 >	•
50	SUPER CAB PLUS	98 >	•
100	CAB	98 >	•
100	EZ	00 >	•
110	FX	02 >	•
110	MIDAS PLUS	98 >	•

**ITALJET**

50	CRUISE	94 >	•
----	--------	------	---

**KEEWAY**

50	FLASH	07 >	•
50	HURRICANE	06 >	•
90	HURRICANE	06 >	•

**KREIDLER**

50	FLORETT	99 >	•
----	---------	------	---

**LINHAI**

50	PRINCE	06 >	•
125	EGGY	06 >	•

**MAICO**

50	CRUISER	99 >	•
50	HARD ENDURO	99 >	•
50	SUPER CROSS	99 >	•

50	SUPERBIKE	99 >	•
50	THUNDERBIKE,II	99 >	•

**MALAGUTI**

125	BLOG	10 >	•
160	BLOG	10 >	•

**MZ**

50	MOSKITO MUZ	00 >	•
----	-------------	------	---

**PEUGEOT**

50	BUXY R (HENGTONG CAL.)	93 > 97	•
50	KISBEE	10 >	•
50	KISBEE RS	11 >	•
50	SPEEDAKE (HENGTONG CALIPER)	94 >	•
50	SPEEDFIGHT	97 >	•
50	SQUAB (HENGTONG CALIPER)	94 >	•
50	TREKKER OFFROAD	99 >	•
50	VIVACITY (HENGTONG CAL.)	05 >	•
100	SPEEDFIGHT	96 >	•
100	VIVACITY (HENGTONG CALIPER)	05 >	•

**PGO**

50	COMET	91 > 92	•
50	GALAXY	91 >	•
50	PS	93 >	•
50	ROAD 66	95 >	•
90	GALAXY	92 >	•

**SIAMOTO**

50	MAT	98 >	•
100	MAT	97 >	•

**SMC**

50	EASY RIDER	97 >	•
----	------------	------	---

**SULA**

50	THUNDER BIRD	99 >	•
100	THUNDER BIRD	99 >	•
125	THUNDER BIRD	99 >	•

**SUZUKI**

50	AE	88 >	•
50	AH ADRESS	92 > 95	•
50	SEPIA	92 >	•
50	TUNE	92 >	•
50	ZZ	92 >	•
80	AH ADRESS	88 >	•

100	AH ADRESS	91 >	•
125	AN	93 > 93	•
125	LIDO VARIO	90 >	•

**TGB**

50	101 S	99 >	•
50	202 T	99 >	•
50	303 R	99 >	•
50	309 RS	00 >	•
50	409 F	00 >	•
50	AKROS	93 >	•
50	BULLET RR	11 >	•
50	BULLET RS	11 >	•
50	BUNNY	97 >	•
50	ERGON	93 >	•
50	HIW'S	99 >	•
50	HOOK	10 >	•
50	TAPO RS	11 >	•
90	101 S	99 >	•
90	202 T	99 >	•
90	AKROS	99 >	•

90	ERGON	99 >	•
90	HIW'S	99 >	•
125	101 S	99 >	•
125	202 T	99 >	•
125	303 R	99 >	•
125	309 RS	00 >	•
125	409 F	00 >	•
125	BULLET RR	11 >	•
125	BULLET RS	11 >	•
125	HOOK	10 >	•
150	303 R	00 >	•
150	309 RS	00 >	•
150	409 F	00 >	•

**UVM**

50	BETHERE	99 >	•
50	BINGO	99 >	•
125	BETHERE	99 >	•
125	BINGO	99 >	•
125	PARAGON	99 >	•



**07027.CC**

76.9 x 41.9 x 7

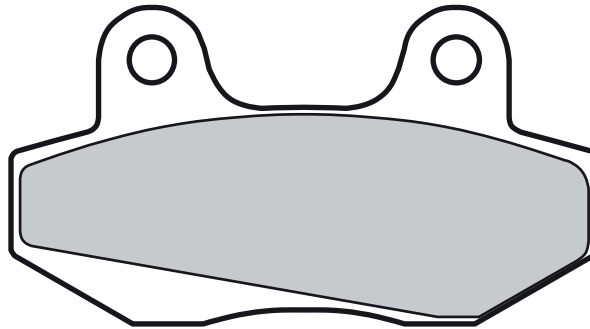
**AXY**

50	SLURP	08 >	•
125	GULP	07 >	•
125	SLURP	08 >	•
125	YUK	07 >	•
150	GULP	07 >	•
150	SLURP	08 >	•
150	YUK	07 >	•
200	GULP	07 >	•
200	YUK	07 >	•
300	ROAR	08 >	•

**CAGIVA**

50	MITO	99 >	•
116	STELLA	97 >	•

**DAELIM**

110	CITY ACE	03 >	•
-----	----------	------	---

**GARELLI**

125	JOKER	02 >	•
150	JOKER	02 >	•

**HONDA**

50	MBX FW, FWD, SW	83 >	•
50	MBX S	83 >	•
50	NS AERO	88 >	•
50	NS-1	91 >	•
50	NSR	87 >	•
75	NSR	88 >	•
80	MBX	83 > 85	•
80	MBX DX	82 >	•
80	MBX SW, SWD	83 >	•
80	MCX S	82 >	•
80	NSR R	87 > 92	•
125	CBX CUSTOM	88 >	•
125	FJ SONIC	03 >	•
125	MBX RWB	84 >	•
250	CB REBEL	86 >	•
250	CMX REBEL	85 > 95	•

**HYOSUNG**

125	EXCEED	02 >	•
125	GRAN PRIX PLUS	02 >	•
125	GT COMET	02 > 04	•
125	GV AGUILA	02 > 04	•
125	RT KARION	02 > 06	•

125	RX	00 >	•
125	XRX	99 > 06	•
250	GV	02 >	•
400	XRV	05 >	•
600	COMET	03 >	•

**KYMCO**

100	SPIKE	02 >	•
110	SPIKE	03 >	•
125	CK	04 >	•
125	JETIX	08 >	•
125	SPIKE	02 >	•

**MZ**

125	(MUZ) MANTIZZ S	07 >	•
-----	-----------------	------	---

**SACHS**

50	MADASS	04 > 04	•
50	MADASS	05 >	•

**SYM**

125	WOLF	02 >	•
125	WOLF CLASSIC	05 >	•
180	MF	03 >	•



**07028.CC** 74.9 x 36.1 x 9.5

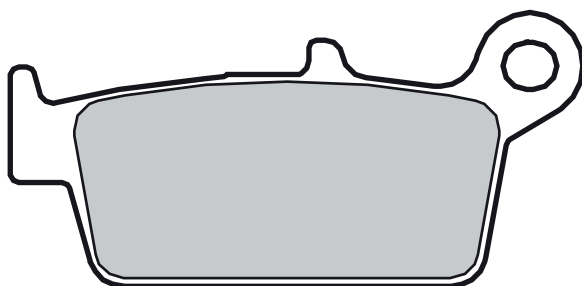
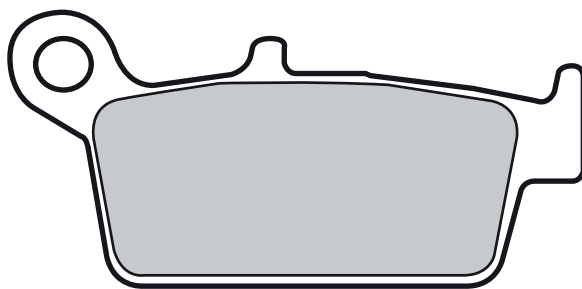

### HONDA

50	SHADOW	98 >	•
50	SKY CLASSIC	00 >	•
50	SKY VETRO	00 >	•
50	SXR SHADOW	98 >	•
90	SHADOW	98 >	•



### KYMCO

50	COBRA CROSS	99 >	00 •
50	COBRA RACER	99 >	00 •
50	SUPER 9	00 >	01 •
50	ZX SUPER FEVER	02 >	•
50	ZX12	06 >	•



90	HANBOY	96 >	•
125	SUPER 9	00 >	•
250	SUPER 9	00 >	•



**07029.CC** 86.1 x 39.9 x 10.7

**07029.XS** “ “ “

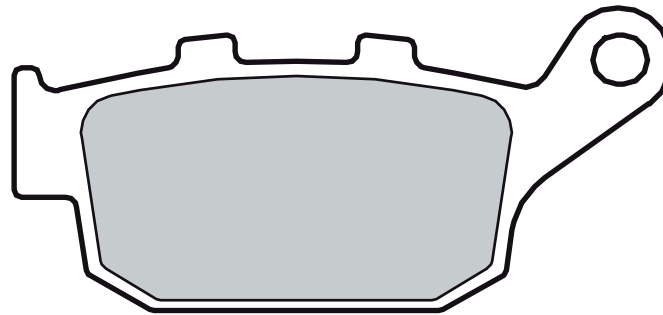
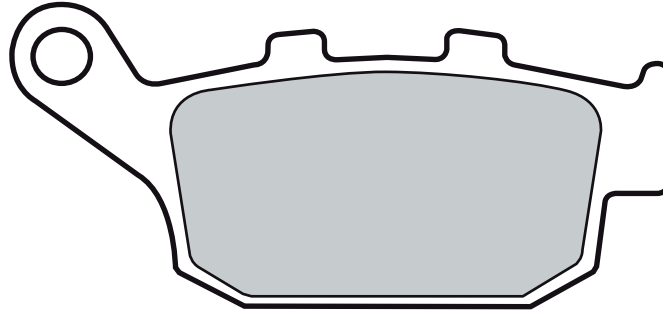

**HONDA**

125	PANTHEON FES	03 >	•
150	PANTHEON FES	03 >	•
250	FORESIGHT	00 >	•

**PEUGEOT**

250	SV	02 >	•
-----	----	------	---



**07031.CC** 51.7 x 36.5 x 8.3

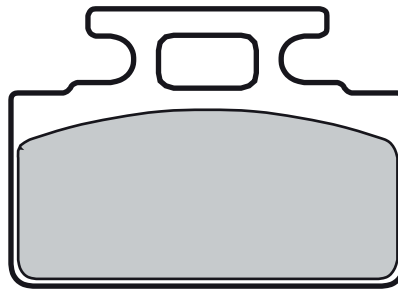

### HONDA

50	NH LEAD	86 > 93	•
90	LEAD	89 >	•
125	NS	89 >	•
250	NS	89 >	•
250	RS R	93 >	•

### KYMCO

50	MANBOY	95 >	•
50	ZAP	95 >	•
90	YUP SP	95 >	•

### SANYANG

50	FEEL BIG	98 >	•
50	PURE	98 >	•

### SYM

50	BULLET	93 >	•
50	CINDARELLA	01 >	•
50	DD	02 >	•
50	FEEL BIG	98 >	•
50	MIO	05 >	•
50	PURE	98 >	•
100	CINDARELLA	01 >	•
100	MIO	05 >	•



**07032.CC** 40.9 x 42.7 x 8

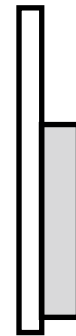
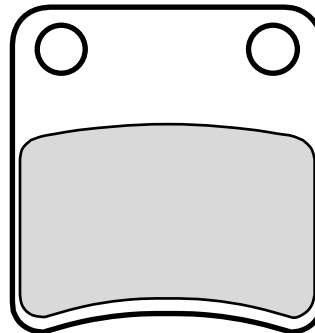

### BS VILLA

50	ZX	93 >	•
----	----	------	---

### CAGIVA

50	CITY	92 > 94	•
----	------	---------	---

### DAELIM

50	BONITA	09 >	•
50	GZ	98 >	•

### GARELLI

125	PANTHER	02 >	•
150	PANTHER	02 >	•
250	PANTHER	02 >	•

### HONDA

50	CRM	93 > 96	•
50	GP DIO	90 > 97	•
50	SR DIO	90 > 93	•
50	ZX DIO	90 > 93	•

### SANYANG

50	SUPER FANCY	98 >	•
----	-------------	------	---

### SYM

50	CHA-CHA	99 >	•
50	CINDARELLA	99 > 00	•
100	CINDARELLA	99 > 00	•



**07033.CC** 76.9 x 41.9 x 9.2  
96.6 x 41.9 x 9.2

**07033.XS** “ “ “

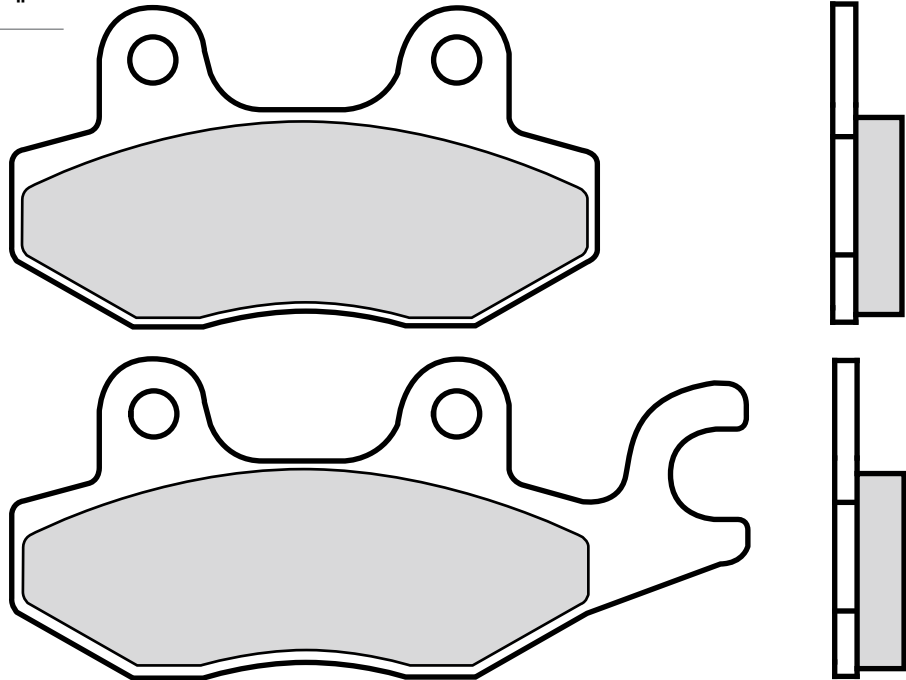

### AEON

120 OZ	14 >	•
125 URBAN	14 >	•

### DAELIM

125 ROADWIN	04 >	•
125 S3	11 >	•
150 ROADWIN X5	06 >	•
250 ROADWIN	08 >	•

### HONDA

75 NS 1	92 >	•
80 NSR R	93 >	•

### KEEWAY

100 PARTNER	06 >	•
110 PARTNER	06 >	•
125 SPEED	06 >	•
150 SPEED	06 >	•

### KYMCO

50 AGILITY 4-STROKE	05 >	•
50 B & W	01 > 05	•
50 DINK	98 >	•
50 DINK CLASSIC	02 >	•
50 K-PIPE	12 >	•
50 LIKE	10 >	•
50 NEW DINK	08 >	•
50 SPACER	99 >	•

50 SUPER 9	02 >	•
50 SUPER 9 L.C.	02 >	•
50 YAGER	01 >	•
100 COBRA RACER	99 >	•
125 AGILITY 16 PLUS	14 >	•
125 B & W	00 >	•
125 DINK	98 >	• •
125 DINK CLASSIC	02 >	• •
125 DINK LX	99 >	• •
125 GRAND DINK	02 >	• •
125 HIPSTER	01 >	•
125 JOYRIDE	01 >	•
125 LIKE	10 >	•
125 MOVIE XL	99 >	•
125 NEW DINK	08 >	• •
125 PULSAR	01 >	•
125 SPACER	99 >	• •
125 TECHNO GT	06 >	•
125 YAGER	01 >	• •
125 YAGER GT	09 >	•
125 ZING	96 >	• •
150 AGILITY R16	08 >	•
150 B&W	00 >	• •
150 DINK	98 >	• •
150 DINK LX	98 >	• •
150 GRAND DINK	02 >	• •
150 HIPSTER	01 >	•
150 JOYRIDE	01 >	•
150 MOVIE XL	01 >	•
150 QUANON	10 >	• •
150 SPACER	99 >	• •

150 YAGER	01 >	• •
150 ZING	99 >	•
200 AGILITY	11 >	•
200 AGILITY 16 PLUS	14 >	•
200 AGILITY R16	11 >	•
200 DINK CLASSIC	04 >	• •
200 LIKE 200 I	10 >	•
200 NEW DINK	08 >	• •
200 YAGER	04 >	• •
250 B & W	00 >	• •
250 PEOPLE	03 >	•
250 PEOPLE S left caliper	06 >	•
250 YUP	03 >	• •
300 PEOPLE S	08 > 10	•
300 PEOPLE S1 left caliper	08 >	•
400 G 3 RIGHT CALIPER	00 >	•

### MOTOR UNION

125 MAXI	99 >	• •
150 MAXI	99 >	• •
150 MIDI	99 >	• •
400 MAXI	99 >	• •

### SYM

125 RS	05 >	•
150 RS	05 >	•

### TGB

50 BUFFALO	03 >	•
50 FIRE, SKY	03 >	•



**07034.CC** 115 x 40.1 x 9.4

**07034.XS** “ “ “

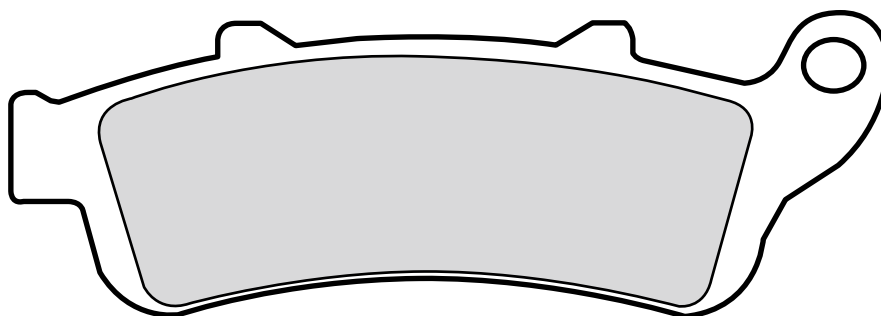

### HONDA

125 PANTHEON	98 > 02	•
125 PANTHEON FES	98 > 02	•
125 PANTHEON FES	03 >	•
150 PANTHEON	98 > 02	•

150 PANTHEON FES	98 > 02	•
150 PANTHEON FES	03 >	•
250 FORESIGHT	97 > 99	•
250 FORESIGHT	00 >	•
250 FORZA	00 > 04	•

250 NSS JAZZ	00 > 04	•
1100 ST A6 ABS-TCS-CBS	96 >	•

### PEUGEOT

250 SV	02 >	•
--------	------	---

**07035.CC**

76.9 x 41.9 x 9.2

96.6 x 41.9 x 9.2

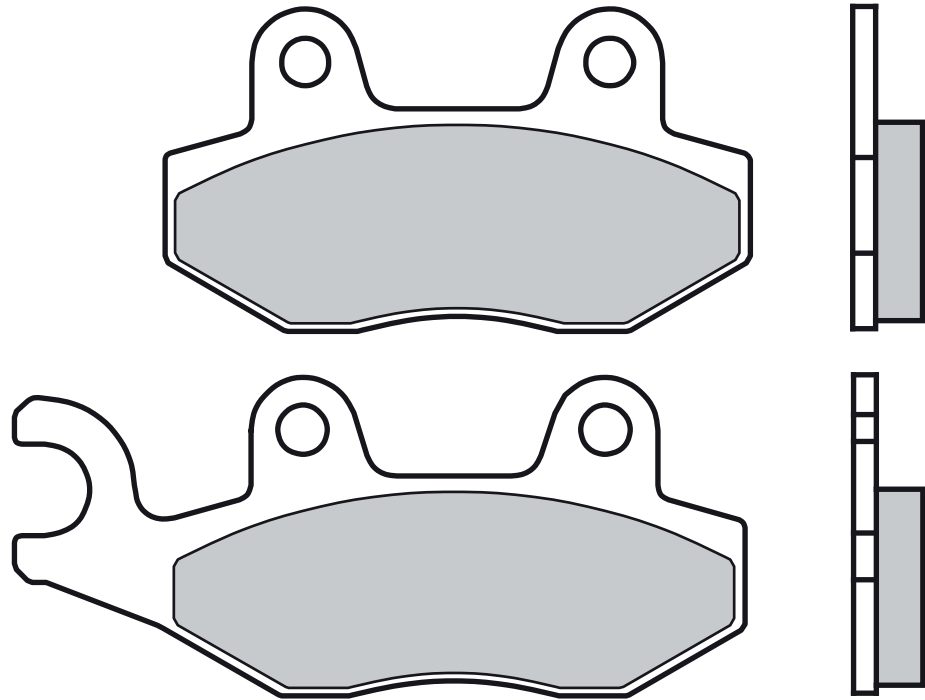
**AEON**

125 ELITE	13 >	•
125 URBAN	11 > 13	•
200 ELITE	11 >	•
350 URBAN	11 >	•
400 ELITE	13 >	•

**BENELLI**

150 CAFFE' NERO	11 >	• •
-----------------	------	-----

**DAELIM**

50 A-FOUR	06 >	•
125 DELFINO	08 >	•

**HONDA**

250 CMX REBEL	97 >	•
---------------	------	---

**KEEWAY**

125 SUPERLIGHT	06 >	•
150 SUPERLIGHT	06 >	•
250 LAND CRUISER	06 >	•

**KREIDLER**

125 ENDURO	07 >	•
125 SUPERMOTO	07 >	•
200 ENDURO	07 >	•

**KYMCO**

50 AGILITY R10	06 >	•
50 AGILITY R12	06 >	•
50 FILLY	02 >	•
50 NEW SENTO	11 >	•
50 RS AGILITY NAKED	10 >	•
50 SENTO	08 > 10	•
50 YUP SP	02 >	•
125 AGILITY	05 > 07	•
125 AGILITY CITY	11 >	•
125 LIKE	10 >	•
125 MOVIE	98 >	•
125 STRYKER	99 >	•
125 VIVIO	00 >	•
150 STRYKER	01 >	•
150 VIVIO	00 >	•
200 LIKE 200 I	10 >	•
250 PEOPLE S right caliper	06 >	•
300 PEOPLE S	08 > 10	•
300 PEOPLE SI right caliper	08 >	•
400 G 3 LEFT CALIPER	00 >	•

**MALAGUTI**

125 BLOG	10 >	•
125 CENTRO IE	08 >	•
160 BLOG	10 >	•
160 CENTRO IE	08 >	•

**MZ**

125 SM	02 >	•
125 SX	02 >	•

**PEUGEOT**

250 GEOPOLIS	06 >	• •
250 SATELIS	06 >	• •

**PGO**

125 CHARGE	03 >	•
------------	------	---

**TGB**

50 203	05 >	•
50 APOLLO	99 >	•
90 APOLLO	99 >	•
250 DYNASTY	06 >	•

**07036.CC**

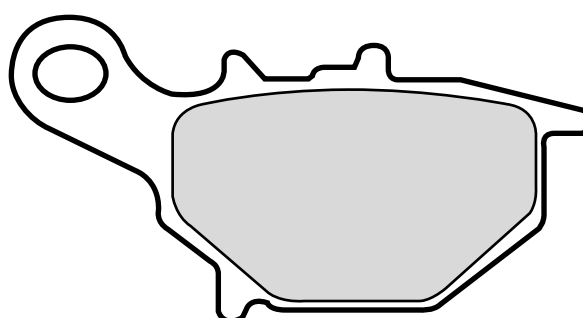
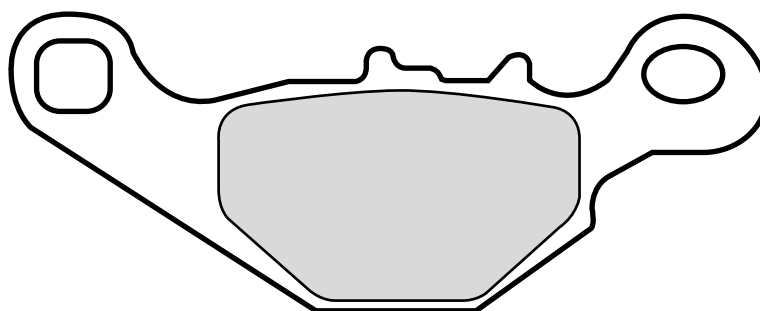
 99.2 x 39.7 x 7.6  
 75.4 x 40.7 x 8.4

**SUZUKI**

50 AN	95 > •
50 STREET MAGIC	98 > •
80 RM T	96 > •
85 RM	02 > 04 •

110 HOKUTO UG	00 > •
125 AN	94 > •
125 DR Z	03 > •
125 EPICURO UC	99 > •
125 VECSTAR	94 > •

150 AN	96 > •
150 EPICURO UC	99 > •
150 UE	02 > •
250 EPICURO	99 > •
250 VECSTAR	94 > •







<b>07037.CC</b>	44.5 x 53.5 x 8.6
<b>07037.XS</b>	“ “ “

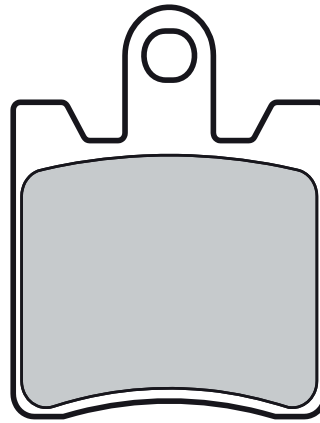

### DAELIM

125 OTELLO	08 >	•
125 S2 FI	07 >	•
125 S3	11 >	•
125 U3 FI	07 >	•

### KAWASAKI

250 SC EPSILON	02 >	•
----------------	------	---



### SUZUKI

250 BURGMAN	98 > 03	•
250 BURGMAN	04 > 06	•
250 SKY WAVE TYPE II	98 >	•
400 BURGMAN	99 > 00	•
400 BURGMAN	01 > 06	•

### SYM

200 JOYRIDE EVO	09 >	•
250 GTS	07 >	•
250 RV EFI	10 >	•
300 GTS	09 >	•
300 GTS EVO	11 >	•
300 JOY MAX EVO	10 >	•
300 JOYRIDE EVO	10 >	•
500 GT	07 >	•



<b>07038.CC</b>	80.9 x 41.7 x 9.3
<b>07038.XS</b>	“ “ “

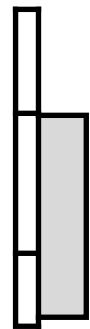
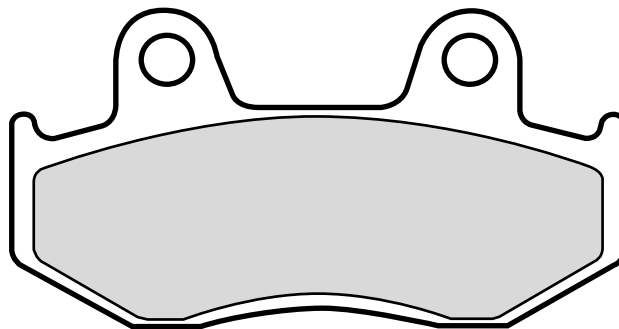

### HONDA

110 LEAD	08 > 09	•
110 SCV	08 >	•
125 @ NES	00 >	•
125 DYLAN	02 >	•
125 PS	07 >	•



### SUZUKI

125 SH MODE	01 > 08	•
150 @ NES	00 >	•
150 DYLAN	02 >	•
150 PS I	06 >	•
250 CN SPAZIO	88 > 89	•

### SUZUKI

250 BURGMAN	98 > 03	•
250 SKY WAVE TYPE II	98 >	•
400 BURGMAN	99 > 00	•





**07039.CC** 70.9 x 36.1 x 9.2

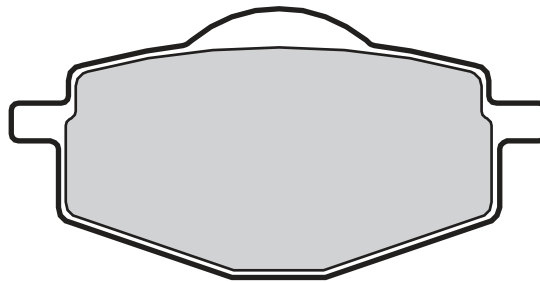

### AXY

125 GULP	07 >	•
125 SLURP	08 >	•
125 YUK	07 >	•
150 GULP	07 >	•
150 SLURP	08 >	•
150 YUK	07 >	•
200 GULP	07 >	•
200 YUK	07 >	•

### GARELLI

XO ELETTRIC	12 >	•
125 XO	12 >	•
150 XO	12 >	•
200 XO	12 >	•

### MBK

125 FLAME R	95 > 03	•
125 NEW FLAME	99 >	•
150 VERTEX	97 >	•

### YAMAHA

50 CYGNUS	96 >	•
105 CRYPTON	98 >	•
125 CYGNUS	96 > 10	•
125 CYGNUS F	00 >	•
150 FLY ONE	92 >	•
150 FLY ONE R	98 >	•

### MALAGUTI

125 CENTRO IE	08 >	•
160 CENTRO IE	08 >	•



**07040.CC** 93.6 x 35.8 x 10.1

**07040.XS** “ “ “

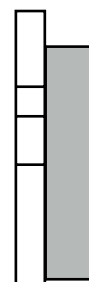
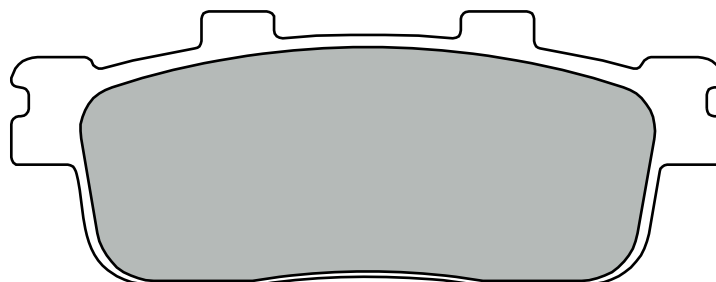

### PEUGEOT

125 LXR	10 >	•
200 LXR	10 >	•

125 JOYRIDE EVO	10 >	•
125 JOYRIDE S	16 >	•
200 HD EVO	07 >	•
200 JOYRIDE S	16 >	•
250 GTS	07 >	•
250 JOYMAX	07 >	•
250 RV EFI	10 >	•
300 GTS EVO	11 >	•

300 JOY MAX EVO	10 >	•
300 JOYRIDE EVO	10 >	•

### SYM

125 EVO	14 >	•
125 HD EVO DT	10 >	•

### TGB

125 X-LARGE	11 >	•
125 X-MOTION	08 >	•
250 X-MOTION	08 >	•
300 X-MOTION	11 >	•

**07041.CC**

61 x 27 x 7.3

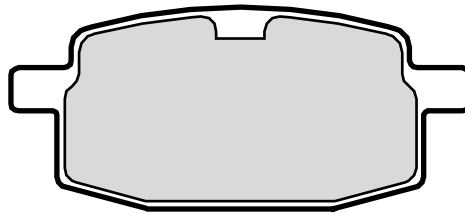
**ADLY**

50	CAT	01 >	•
50	COSY	01 >	•
50	FOX	00 >	•
50	FOX PLUS	01 >	•
50	JET	96 >	•
50	PISTA	96 >	•
50	ROAD TRACER	02 >	•
50	SILVER FOX	00 > 05	•
70	FOX PLUS	01 >	•
70	PISTA	01 >	•
80	COSY	01 >	•
90	ROAD TRACER	02 >	•
100	CAT	01 >	•
100	JET	96 >	•
100	ROAD TRACER	02 >	•
100	SILVER FOX	01 > 05	•
125	CAT	01 >	•

**BENELLI**

50	KB-X RACE	95 >	•
----	-----------	------	---

**CAGIVA**

50	CITY	08 >	•
----	------	------	---

**FANTIC MOTOR**

50	BIG WHEEL	93 >	•
50	FLYING TIGER	96 >	•
50	GRINTA	95 >	•
50	LEADER	95 >	•
50	QUEENIE	95 >	•
50	SPIKE	96 >	•

**GARELLI**

50	BIG WHEEL	93 >	•
50	BIP-RACING	94 >	•
50	FX	02 >	•
50	PONY SR	95 >	•
50	RALLY PMX	00 >	•
125	XO' I	10 > 11	•
150	XO' I	10 > 11	•
200	XO' I	10 > 11	•

**ITALJET**

50	BAZOOKA	92 >	•
50	PISTA	93 >	•
50	SCOOP	93 >	•
50	YANKEE	93 >	• •

**KL**

50	KRX	98 >	•
50	KRYPTON	99 >	•
50	XR7	98 >	•
125	NOX	00 >	•
125	PROXY	01 >	•
125	PULSAR	00 >	•
150	NOX	00 >	•
150	PROXY	01 >	•
150	PULSAR	00 >	•

**LEM**

50	FLASH	93 >	•
----	-------	------	---

**MBK**

50	TARGET	92 >	•
100	BOOSTER	01 >	•

**MZ**

50	MOSKITO MUZ	99 > 99	•
125	MOSKITO MUZ	99 >	•

**PETERSON**

50	HURRICANE	95 >	•
50	SR	95 >	•
80	80 SR	95 >	•
80	HURRICANE	95 >	•

**PEUGEOT**

50	V-CLIC	08 >	•
----	--------	------	---

**PGO**

50	BIG MAX	95 > 02	•
50	BIG MAX SPORT	96 >	•

50	COMET	93 >	•
50	EPS	96 >	•
50	HOT	97 >	•
50	MEGA	96 >	•
50	PMX	97 > 00	•
50	TORNADO	96 >	•
80	BIG MAX	94 >	•
90	BIG MAX	97 >	•
90	TORNADO	00 >	•
100	BIG MAX	97 >	•
110	PMX	00 >	•
125	KUNG FU	70 >	•
125	TORNADO	96 >	•

**SHE-LUNG**

50	FALCON	97 >	•
125	MARS	97 >	•

**SIAMOTO**

50	BIRDIE	98 >	•
50	TOP RACING	98 >	•
125	FAVOURITE	00 >	•
150	FAVOURITE	00 >	•

**SULA**

50	CITY BIRD	99 >	•
----	-----------	------	---

**TGB**

250	DYNASTY	06 >	•
-----	---------	------	---

**YAMAHA**

50	CHAMPS RS	88 >	•
50	CRZ	92 >	•
50	TARGET	91 >	•
80	TZR	92 >	•
90	AXIS	94 >	•
90	JOG-Z	90 >	•
90	TARGET	91 >	•



**07042.CC** 94 x 40.7 x 10

**07042.XS** “ “ “

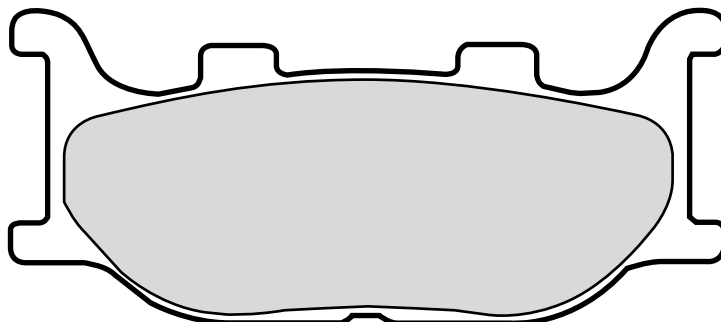

### ITALJET

125 JUPITER	02 >	•
150 JUPITER	02 >	•
250 JUPITER	00 >	•

### LINHAI

125 MONARCH	06 >	•
150 MONARCH	06 >	•
300 MAIN STREET	06 >	•

### MBK

250 SKYLINER	00 >	•
400 SKYLINER	04 >	•

### YAMAHA

250 MAJESTY	96 >	•
250 MAJESTY ABS	98 > 05	•
250 MAJESTY DX	98 > 99	•
250 MAJESTY DX ABS	98 >	•

400 MAJESTY	05 >	•
500 T MAX	04 > 07	•
500 T MAX ABS	06 >	•
500 T MAX BLACK MAX	06 >	•



**07043.CC** 99.6 x 31 x 9

**07043.XS** “ “ “

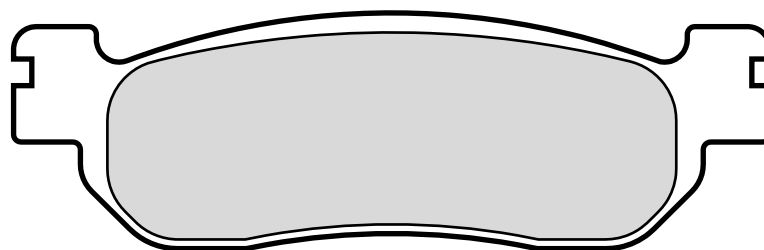

### LINHAI

125 MONARCH	06 >	•
150 MONARCH	06 >	•
300 MAIN STREET	06 >	•

### MBK

250 SKYLINER	00 >	•
--------------	------	---

### YAMAHA

125 X MAX ABS/ BUSINESS ABS	11 >	•
125 X MAX IRON MAX	16 >	•
125 X MAX MOMODESIGN	15 >	•
250 MAJESTY DX	98 > 99	•
250 MAJESTY DX ABS	98 >	•
250 X MAX	06 > 09	•

250 X MAX	10 > 13	•
250 X MAX ABS	11 > 13	•
250 X MAX IRON MAX	16 >	•
250 X MAX MOMODESIGN	16 >	•
250 X-CITY	08 >	•
400 X MAX	13 >	•
400 X MAX ABS	13 >	•
400 X MAX IRON MAX	16 >	•

**07044.CC**

35.7 x 45.4 x 6

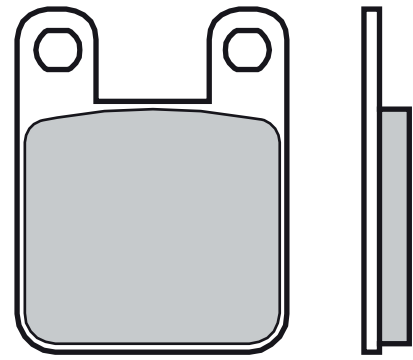
**APRILIA**

50 RS	06 >	•
50 RX	06 >	•

**BETA**

150 EIKON	99 > 03	• •
-----------	---------	-----

**CAGIVA**

50 MANTIS	98 >	•
50 PROGRESS	98 >	•

**DAELIM**

50 HISTORY	01 >	•
50 VARIANT SPORT - R	01 >	•

**DERBI**

50 ATLANTIS	99 >	•
50 ATLANTIS 4-STROKE	04 >	•
50 ATLANTIS BULLET	04 >	•
50 ATLANTIS CITY	06 >	•
50 ATLANTIS H2O	01 >	•
50 ATLANTIS H2O WAVE	01 >	•
50 ATLANTIS TO CHIC	05 >	• •
50 ATLANTIS WAVE	01 >	•
50 AVENTURA	96 >	•
50 BOULEVARD	09 >	•
50 DS	88 >	•
50 FURAX	96 >	• •
50 GP1	01 > 04	• •
50 GP1	05 >	•
50 HUNTER	96 > 97	•
50 MANHATTAN	99 >	• •
50 PADDOCK	97 >	•
50 PREDATOR	97 > 00	• •
50 RAMBLA	06 >	• •
50 STINGER	96 >	•
50 VAMOS (AJP CALIPER)	95 > 97	•
50 VARIANT SPORT - R	01 >	•
100 ATLANTIS 4-STROKE	04 >	•
100 ATLANTIS H2O	01 >	•
200 BOULEVARD	06 >	•
250 GP1	05 >	•

**GARELLI**

50 SAHEL	91 >	•
50 XO	12 >	•

**GILERA**

125 SURFER	00 >	• •
------------	------	-----

**HYOSUNG**

50 WRS	98 >	•
--------	------	---

**ITALJET**

50 DRAGSTER	97 > 98	• •
50 FORMULA AIR	99 >	•
50 FORMULA LC	98 >	• •
50 JET SET	02 >	•
50 NEW TORPEDO	00 >	•
50 TORPEDO	97 >	•
50 TORPEDO 4T	01 >	•
125 DRAGSTER (AJP CAL.)	97 >	• •
125 FORMULA (AJP CAL.)	95 >	• •
125 JET SET	02 >	•
125 JUPITER	02 >	•
125 TORPEDO 4T	99 >	•
125 TWIN	98 >	• •
150 JET SET	02 >	•
150 JUPITER	02 >	•
150 TORPEDO 4T	99 >	•
180 DRAGSTER (AJP CAL.)	99 >	• •

**MALAGUTI**

50 FIFTY	04 >	•
----------	------	---

**MBK**

50 X LIMIT	04 >	• •
50 X POWER	04 >	•

**PEUGEOT**

50 BLASTER	09 >	•
50 BLASTER FURIOS	11 >	• •
50 BLASTER RS12	09 >	• •
50 ELYSEO (AJP CALIPER)	99 > 01	• •
50 ELYSTAR	03 >	•
50 JET C-TECH DARKSIDE	10 >	• •
50 JET C-TECH ICE BLADE	10 >	• •
50 JET FORCE	03 >	• •
50 JET FORCE C-TECH	05 >	• •
50 LUDIX	04 >	•
50 LUDIX CLASSIC	04 >	•
50 LUDIX ELEGANCE	04 >	•
50 LUDIX SNAKE	04 >	•

50 LUDIX TREND	04 >	•
50 METAL X	01 >	•
50 SPEE DAKE (AJP CAL.)	95 > 97	•
50 SPEED FIGHT (AJP CAL.)	99 >	•
50 SPEED FIGHT (AJP CAL.)	00 >	• •
50 SPEED FIGHT LEMANS	11 >	• •
50 SQUAB (AJP CALIPER)	96 >	•
50 TKR	96 >	•
50 TKR FURIOUS	05 >	•
50 TKR STREET ZONE	03 >	•
50 TKR WRC	05 >	•
50 TREKKER	99 >	•
TREKKER		
50 STREETBOARD	00 >	•
TREKKER URBAN		
50 BLACK	00 >	•
50 TSDI	04 >	• •
50 VIVACITY	99 > 07	•
50 VIVACITY COMPACT	03 >	•
50 VIVACITY X RACE	03 >	•
50 ZENITH LN/LS	97 >	•
100 ELYSEO	00 >	• •
100 ELYSEO (AJP CALIPER)	98 > 99	•
100 LOOXOR	02 >	•
100 SPEED FIGHT (AJP CAL.)	98 >	• •
100 SPEED FIGHT 2 206		
WRC	03 >	• •
100 SPEED FIGHT 2 FURIORS	03 >	• •
100 TREKKER	99 >	• •
100 VIVACITY	99 > 07	•
100 X-FIGHT	00 >	• •
125 ELYSEO	00 >	•
125 LOOXOR	02 >	•
125 LUDIX	04 >	•
125 SATELIS	04 > 05	•
125 XPS CT	06 >	• •
150 LOOXOR	06 >	•

**PIAGGIO**

50 DIESIS	02 >	•
100 DIESIS	02 >	•

**RIEJU**

50 FIRST	97 >	•
50 TANGO	08 >	•
50 WINDY	97 >	•

**SACHS**

50	MADASS	05 >	•
----	--------	------	---

**SUZUKI**

50	KATANA LC	97 >	•
50	KATANA RX	98 >	•
50	UF ESTELETE	00 >	•
50	UX ZILLION	99 >	•
50	W, WR	00 >	•

**TGB**

50	HAWK	09 >	•
----	------	------	---



**07045.CC** 117.4 x 38.7 x 8.3

**07045.XS** “ “ “

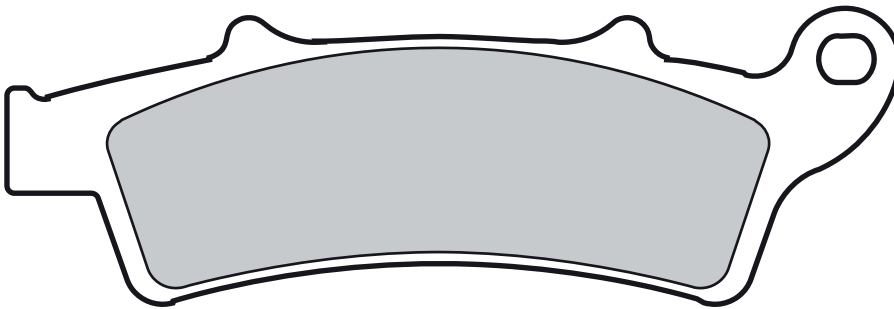
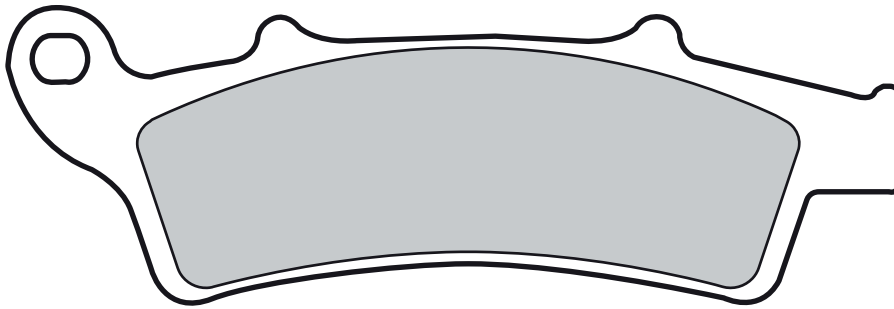

### APRILIA

125 ATLANTIC	03 >	•
125 SCARABEO GT	04 >	•
125 SCARABEO I.E.	08 >	•
150 SCARABEO GT	04 >	•
200 ATLANTIC	03 >	•
200 SCARABEO	07 >	•
200 SCARABEO CLASSIC	10 >	•
200 SCARABEO I.E.	12 >	•
250 ATLANTIC	04 >	•
250 SCARABEO	04 > 05	•
250 SCARABEO I.E.	06 >	•
300 ATLANTIC	10 >	•
300 SCARABEO SPECIAL	10 >	•
400 ATLANTIC SPRINT	06 >	•
500 ATLANTIC SPRINT	06 >	•

### KYMCO

125 DOWNTOWN I ABS	16 >	•
125 KXCTI	14 >	•
125 PEOPLE GTI	10 > 11	•
125 PEOPLE GTI	12 >	•
125 XTOWN I ABS	16 >	•
200 PEOPLE GTI	12 >	•
300 K-XCTI	12 >	•
300 PEOPLE GTI	12 >	•
300 XTOWN I ABS	16 >	•

### MALAGUTI

250 MADISON	99 >	•
400 MADISON	02 >	•

### PEUGEOT

100 LOOXOR	02 >	•
125 LOOXOR	02 >	•
150 LOOXOR	02 > 05	•

### PIAGGIO

350 BEVERLY SPORT TOURING IE	12 >	•
350 BEVERLY SPORT TOURING IE ABS	12 >	•



**07046.CC**

77 x 47.7 x 7.1

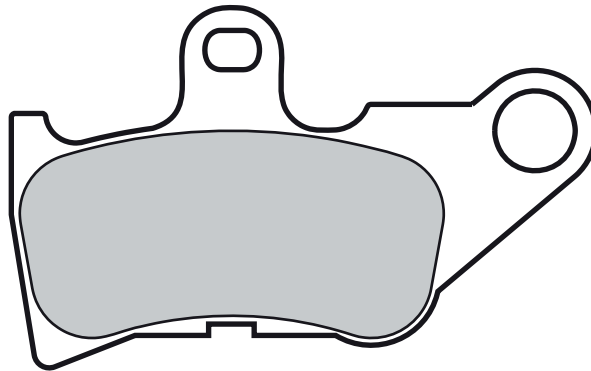
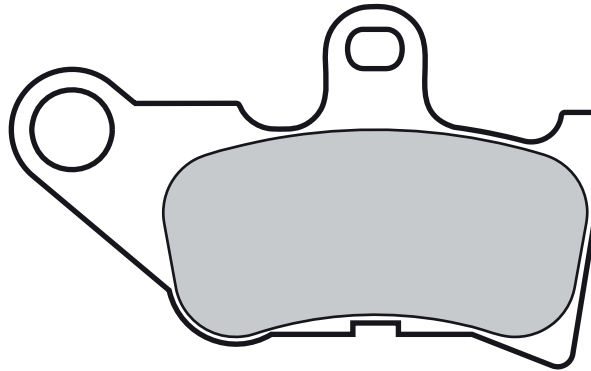

**YAMAHA**

50	JOG	01 >	•
50	JOG ZR	01 >	•



0821 000 555



0821 000 777



**DOM TOM**



+33 3 89 70 3000



+33 3 89 70 30 99





**07047.CC** 55.4 x 49.4 x 7

**07047.XS** " " "

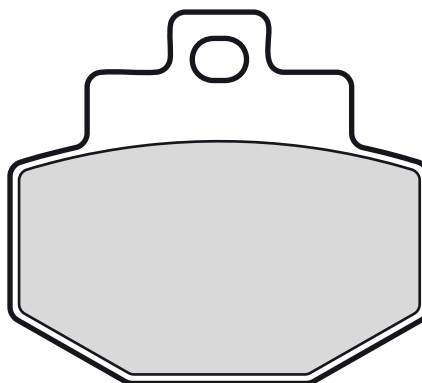

### BENELLI

125 ADIVA	00 >	•
150 ADIVA	00 >	•

### GILERA

125 RUNNER ST	08 > 11	•
125 RUNNER VX 4T (GRIMECA CALIPER)	01 >	•
125 RUNNER VX 4T (HENGTONG CALIPER)	01 >	•
200 RUNNER	03 >	•
200 RUNNER ST	08 >	•

### PIAGGIO

125 946	14 >	•
---------	------	---

125 SKIPPER LX	99 >	•
125 SUPERHEXAGON	01 >	•
125 SUPERHEXAGON (HENGTONG CALIPER)	04 >	•
125 VESPA 946 EMPORIO ARMANI	16 >	•
125 VESPA GRANTURISMO L	04 >	•
125 VESPA GTS	07 >	•
125 VESPA GTS SUPER	10 > 13	•
125 VESPA GTS SUPER	15 >	•
125 VESPA GTS SUPERSPORT	13 >	•
125 VESPA GTV	08 >	•
150 SUPERHEXAGON	01 >	•
180 SUPER HEXAGON GTX 12"	01 > 03	•

180 SUPERHEXAGON	01 >	•
180 SUPERHEXAGON (HENGTONG CALIPER)	00 >	•
200 VESPA GT L	04 >	•
250 SUPERHEXAGON	99 > 01	•
250 VESPA GT 60 EURO3	06 >	•
250 VESPA GTS ABS	06 >	•
250 VESPA GTV	08 >	•
300 VESPA GTS IE	12 >	•
300 VESPA GTS SUPER	09 >	•
300 VESPA GTS SUPER SPORT	11 >	•
300 VESPA GTS TOURING	11 > 12	•
300 VESPA GTV I.E.	11 >	•



**07048.CC** 49.9 x 47.1 x 7

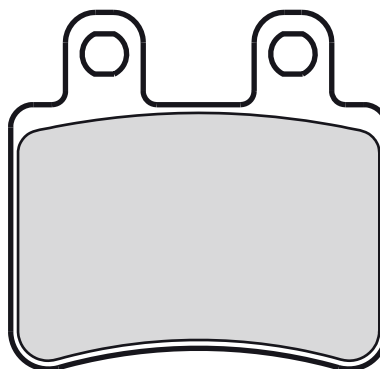

### DERBI

125 BOULEVARD S	04 > 08	•
125 SENDA BAJA	06 >	•
150 BOULEVARD	04 >	•

### ITALJET

100 MILLENIUM	01 >	•
125 MILLENIUM	01 >	•
150 MILLENIUM	01 >	•

### PEUGEOT

50 ELYSTAR	03 >	•
------------	------	---

50 JET C-TECH	05 > 08	•
125 ELYSEO	98 > 99	•
125 ELYSTAR	03 >	•
125 ELYSTAR ABS	03 >	•
125 GEOPOLIS	06 >	•
125 GEOPOLIS RS	10 >	•
125 JET FORCE	03 >	•
125 JET FORCE COMPRESSOR	05 >	•
125 SATELIS	04 > 05	•
125 SATELIS	06 >	•
125 SATELIS ABS	04 >	•
150 ELYSEO	00 >	•
150 ELYSTAR	03 >	•

250 SATELIS	06 >	•
600 SATELIS ABS	04 >	•

### SCORPA

250 T-RIDE	08 >	•
------------	------	---

### SHERCO

125 SE 1.25 F	10 >	•
---------------	------	---

### YAMAHA

50 DT R	04 >	•
50 DT X SUPERMOTARD	04 >	•

**07049.CC**

76.5 x 41.9 x 7.3

94.4 x 42.1 x 7.3

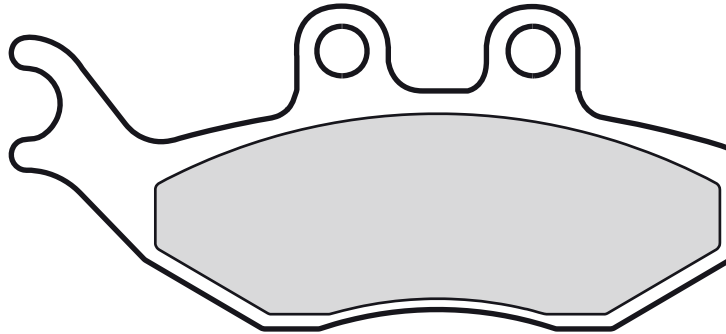
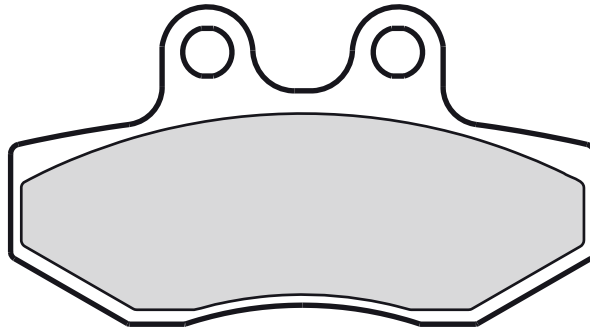
**APRILIA**

50 TUONO	04 >	•
----------	------	---

**BETA**

50 RR ENDURO	10 >	•
50 RR SUPERMOTARD	08 >	•
125 ALP 4-STROKE	06 >	•
125 ALP 4-STROKE (EBE)	06 >	•
125 ENDURO	10 >	•
125 M4	06 >	•
125 M4 (EBE)	06 >	•
125 RR ENDURO	10 >	•
125 RR SUPERMOTARD	08 >	•
125 URBAN	10 >	•
200 ALP 4-STROKE	06 >	•
200 ALP 4-STROKE (EBE)	06 >	•
200 URBAN	10 >	•
350 ALP 4.0	04 > 05	•
350 ALP 4.0	06 >	•
350 ALP 4.0 (EBE)	06 >	•

**DERBI**

50 BLACK DEVIL	04 >	•
50 DRD RACING R	05 >	•
50 DRD RACING R LIMITED EDITION	05 >	•
50 DRD RACING SM	05 >	•
50 DRD RACING SM LIMITED EDITION	05 >	•
50 SENDA SM DRD BLACK ED.	03 >	•

125 MULHACEN	07 > 07	•
125 SENDA 4-STROKE	04 >	•
125 SENDA BAJA	06 >	•
125 SENDA R 4-STROKE	05 >	•
125 SENDA X-TREME SM	04 >	•

**FANTIC MOTOR**

50 MX REGOLARITÀ CASA	08 >	•
50 SUPERSEI MOTARD	08 >	•
125 CABALLERO MOTARD AIRCOOLED	10 >	•
125 MX REGOLARITÀ CASA	08 >	•
125 SUPERSEI MOTARD	08 >	•

**GAS GAS**

50 EC ROOKIE	05 >	•
125 PAMPERA	04 >	•
250 PAMPERA	02 >	•
280 PAMPERA	04 >	•

**HM**

50 CRE	06 >	•
--------	------	---

**KEEWAY**

125 ENDURO	07 >	•
125 X-RAY	07 >	•

**MALAGUTI**

50 FIFTY	04 >	•
50 NKD	04 >	•

125 MADISON 3	08 >	•
125 PHANTOM MAX	04 >	•
200 PHANTOM MAX	04 >	•
250 MADISON 3	08 >	•
250 MADISON RS	05 >	•
250 PASSWORD	06 >	•
250 PHANTOM MAX	05 >	•

**MBK**

50 X POWER	04 >	•
------------	------	---

**PEUGEOT**

50 XPS6 SUPERMOTARD	04 > 05	•
125 ELYSEO	00 >	•
125 ELYSTAR	03 >	•
125 ELYSTAR ABS	03 >	•
125 JET FORCE	03 >	•
125 JET FORCE COMPRESSOR	05 >	•
125 SATELIS	06 >	•
150 ELYSEO	00 >	•
150 ELYSTAR	03 >	•
250 SATELIS	06 >	•

**SHERCO**

50 ENDURO	07 >	•
50 SUPERMOTARD	07 >	•
125 SE 1.25 F	10 >	•

**YAMAHA**

50 DT X SUPERMOTARD	04 >	•
---------------------	------	---



**07050.CC**

44.6 x 50.7 x 7

**07050.XS**

“ “ “

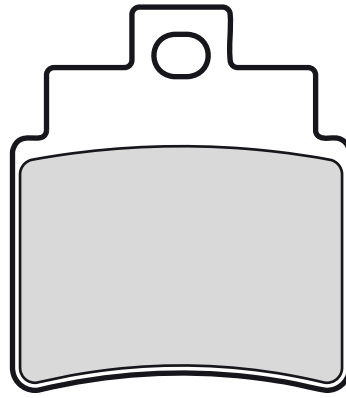

**KYMCO**

250 GRAND DINK 00 > •



**SYM**

125 VOYAGER 05 > •

250 JOYMAX 07 > •

250 VOYAGER 05 > •



**07051.CC**

55.3 x 46 x 7

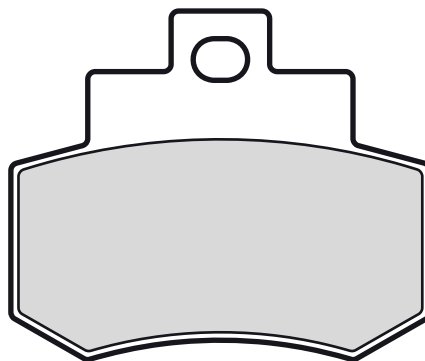

**KYMCO**

250 GRAND DINK 00 > •



**07052.CC** 99.6 x 38.2 x 12

**07052.XS** “ “ “

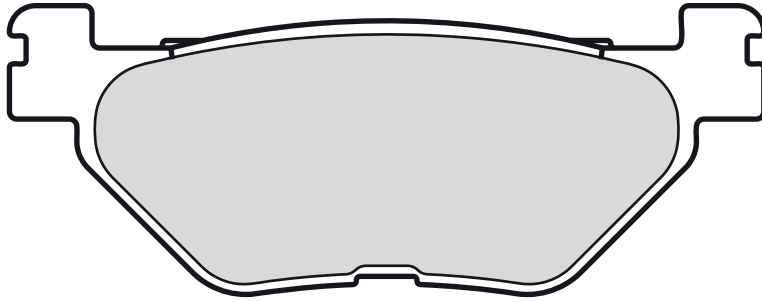

**MBK**

400 SKYLINER 04 > •



**YAMAHA**

500 T MAX 01 > 03 •  
530 T MAX 12 > •



530 T MAX IRON MAX 15 > •

530 T MAX LUX MAX 16 > •





**07053.CC**

85.7 x 40 x 8.9

**07053.XS**

“ “ “

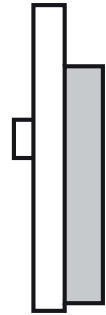
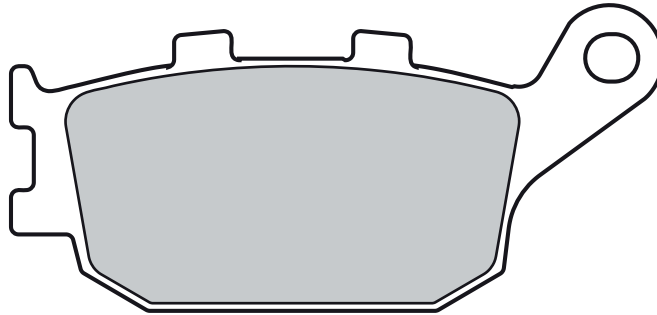
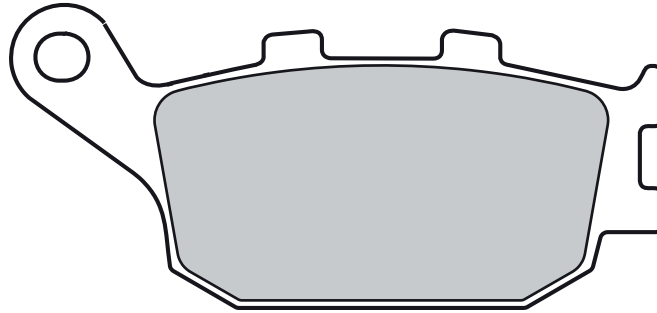

**HONDA**

250	FORESIGHT	97 > 99	•
250	FORZA	00 > 04	•
250	NSS JAZZ	00 > 04	•

**07054.CC**

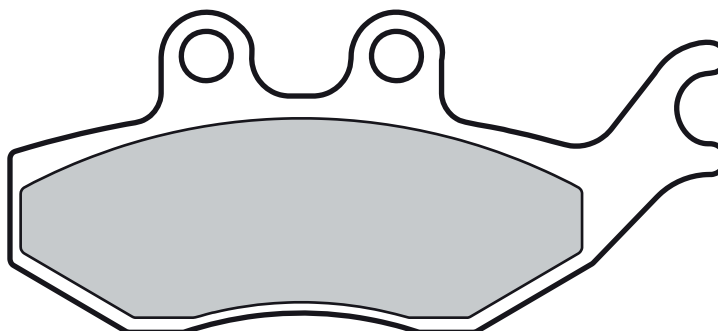
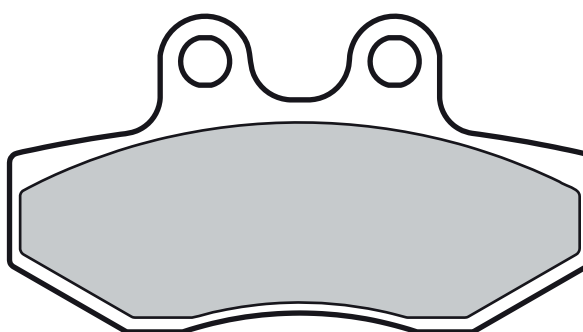
 76.7 x 41.9 x 7.3  
 94.4 x 42.1 x 7.3

**ITALJET**

100	MILLENIUM	01 >	•
125	MILLENIUM	01 >	•
150	MILLENIUM	01 >	•
250	JUPITER	00 >	•

**KEEWAY**

50	SM TX	10 >	•
125	SM TX	10 >	•

**RIEJU**

50	MATRIX	03 >	•
50	NKD	04 >	•

**07055.CC**

80.9 x 41.7 x 8.3

**07055.XS**

“ “ “

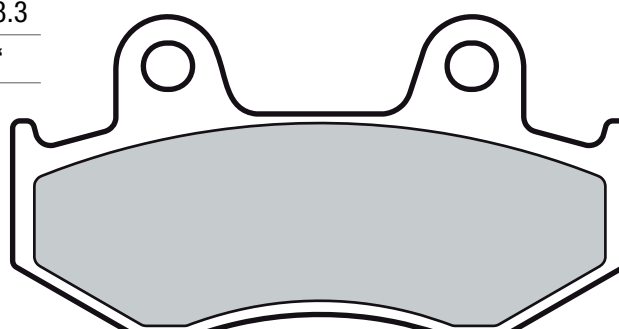
**KAWASAKI**

250	SC EPSILON	02 >	•
-----	------------	------	---

**PIAGGIO**

125	VESPA GTS SUPERSPORT	13 >	•
-----	-------------------------	------	---

**SUZUKI**

250	BURGMAN	04 > 06	•
400	BURGMAN	01 > 06	•



**07056.CC**

76.7 x 41.9 x 9

96.6 x 41.9 x 9

**07056.XS**

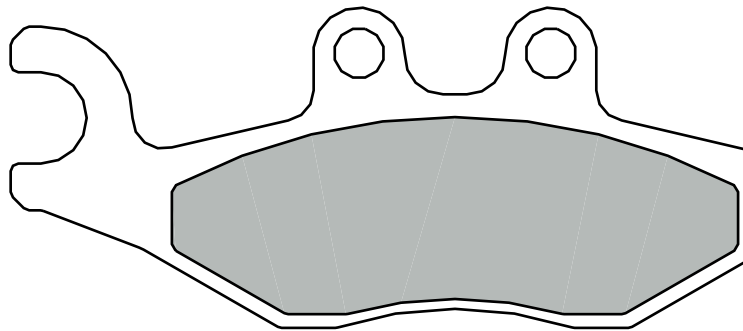
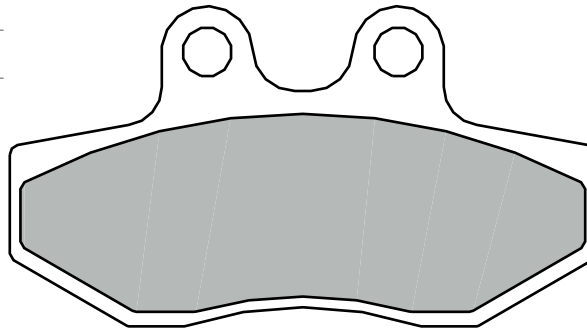
“ “ “

**APRILIA**

50	SPORTCITY ONE	09 >	•
125	MAX	12 >	• •
125	SPORTCITY ONE	12 >	•
125	SR MAX	12 >	• •
300	MAX	12 >	• •
850	SRV	12 >	•

**GILERA**

50	RUNNER PURE JET	06 >	•
50	RUNNER SP	06 >	•
125	NEXUS	09 >	• •
125	RUNNER FX (HENGTONG CALIPER)	00 >	•
125	RUNNER FX SP (HENGTONG CALIPER)	00 >	•
125	RUNNER ST	08 > 11	•
125	RUNNER ST	12 >	•
125	RUNNER VX 4T (HENGTONG CALIPER)	01 >	•
180	RUNNER FXR (HENGTONG CALIPER)	00 >	•
180	RUNNER FXR SP (HENGTONG CALIPER)	00 >	•
180	RUNNER VXR	01 >	•
180	RUNNER VXR 4T (HENGTONG CALIPER)	00 >	•
200	RUNNER ST	08 >	•

200	RUNNER VXR 4T (HENGTONG CALIPER)	01 >	•
250	NEXUS	06 > 08	• •
300	NEXUS	11 >	• •
500	FUOCO I.E.	08 >	•
800	GP 800	07 >	•

**PEUGEOT**

50	CITYSTAR	14 >	•
125	ACTIVE	13 >	•
125	CITYSTAR	11 >	•
125	GEOPOLIS	06 >	•
125	GEOPOLIS RS	10 >	•
200	CITYSTAR	13 >	•
400	GEOPOLIS	08 >	•

**PIAGGIO**

50	FLY	05 >	•
50	LIBERTY 4T	16 >	•
50	TPH 2T	11 >	•
50	VESPA PRIMAVERA	14 >	•
100	FLY	07 >	•
100	ZIP	07 >	•
125	946	14 >	•
125	BEVERLY	02 >	• •
125	BEVERLY EURO3	07 > 08	• •
125	CARNABY	07 >	• •
125	FLY 2T	05 >	•

125	FLY 4T	05 >	•
125	SUPERHEXAGON (HENGTONG CALIPER)	04 >	•
125	VESPA 70 PRIMAVERA	16 >	•
125	VESPA 946 EMPORIO ARMANI	16 >	•
125	VESPA GRANTURISMO L	04 >	•
125	VESPA GTS	07 >	•
125	VESPA GTS SUPER	10 > 13	•
125	VESPA GTS SUPER	15 >	•
125	VESPA GTV	08 >	•
125	VESPA PRIMAVERA	14 >	•
125	X10 EXECUTIVE left/rear	13 >	• •
125	X7	08 >	• •
125	X7 EURO3	08 > 09	• •
125	X8	04 > 04	•
125	X8	05 >	•
125	X9 left caliper	04 > 05	•
125	X9 left caliper	06 >	•
125	X9 PREMIUM EURO2	06 > 07	•
125	XEVO	08 >	•
150	FLY	05 > 07	•
150	FLY 2T	05 >	•
150	FLY 4T	05 >	•
150	FLY EURO3	08 > 10	•
150	VESPA 70 PRIMAVERA	16 >	•
150	VESPA PRIMAVERA	14 >	•
180	SUPERHEXAGON (HENGTONG CALIPER)	00 >	•

200 BEVERLY	01 >	• •	250 X9 EVOLUTION left caliper	05 >	•	400 BEVERLY I.E.	06 >	•
200 CARNABY	07 >	• •	300 BEVERLY I.E.	11 >	•	400 X EVO	08 >	• •
200 VESPA GT L	04 >	•	300 CARNABY CRUISER	10 >	• •	400 X8 ie right caliper	06 >	• •
200 X8	04 >	•	300 VESPA GTS IE	12 >	•	500 MP3 LT TOURING BUSINESS ABS	14 >	•
200 X8	05 >	•	300 VESPA GTS SUPER	09 >	•	500 MP3 LT TOURING SPORT ABS	14 >	•
250 BEVERLY	06 >	•	300 VESPA GTS SUPER SPORT	11 >	•	500 X10 EXECUTIVE left/rear	13 >	• •
250 BEVERLY S	06 >	•	300 VESPA GTS TOURING	11 > 12	•	<b>TRIUMPH</b>		
250 VESPA GT 60 EURO3	06 >	•	300 VESPA GTV I.E.	11 >	•	1700 THUNDERBIRD COMMANDER	14 >	•
250 VESPA GTS ABS	06 >	•	300 X7 EVO I.E.	11 >	•	1700 THUNDERBIRD LT	14 >	•
250 VESPA GTV	08 >	•	350 BEVERLY S	14 >	•			
250 X EVO	08 >	•	350 X10 EXECUTIVE left/rear	13 >	• •			
250 X7	08 >	• •						
250 X8 I.E.	06 >	•						





**07057.CC** 78.9 x 46.9 x 7.3

**07057.XS** “ “ “

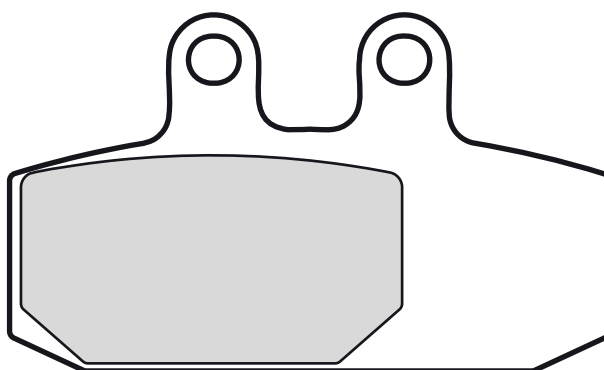
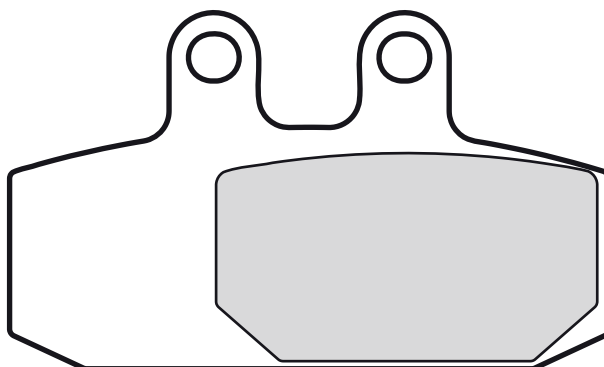

**APRILIA**

400 SCARABEO I.E. 06 > •



500 ATLANTIC 02 > 05 •  
 500 SCARABEO GT ABS left caliper 06 > •  
 500 SCARABEO left caliper



500 SCARABEO ie left caliper 06 > •  
 500 SCARABEO left caliper 04 > 05 •



**07058.CC** 88.2 x 46.1 x 8.4

**07058.XS** “ “ “

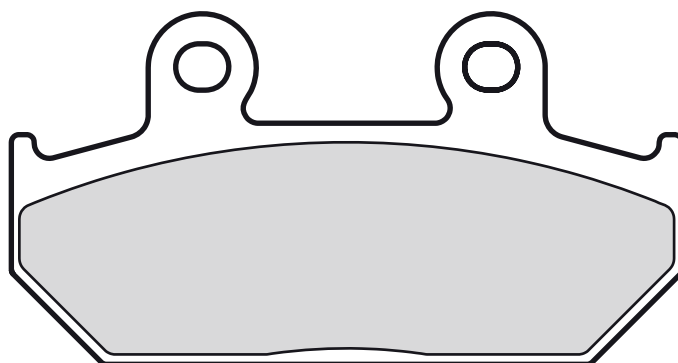

### SUZUKI

400	BURGMAN	07 >	•
650	BURGMAN	02 >	•
650	BURGMAN EXECUTIVE	04 >	•
650	BURGMAN EXECUTIVE	13 >	•



**07059.CC** 96.6 x 37.1 x 11.8

**07059.XS** “ “ “

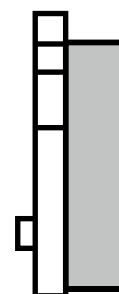
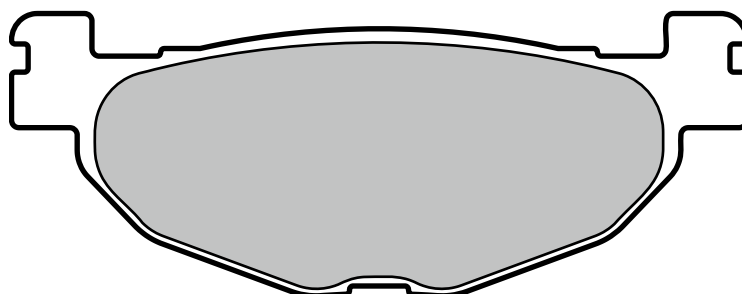

### YAMAHA

400	MAJESTY	04 > 04	•	400	MAJESTY	05 >	•	500	T MAX ABS	06 >	•
				500	T MAX	04 > 07	•	500	T MAX BLACK MAX	06 >	•
				500	T MAX	08 > 11	•				



**07060.CC**

76.7 x 41.9 x 9

96.6 x 41.9 x 9

**07060.XS**

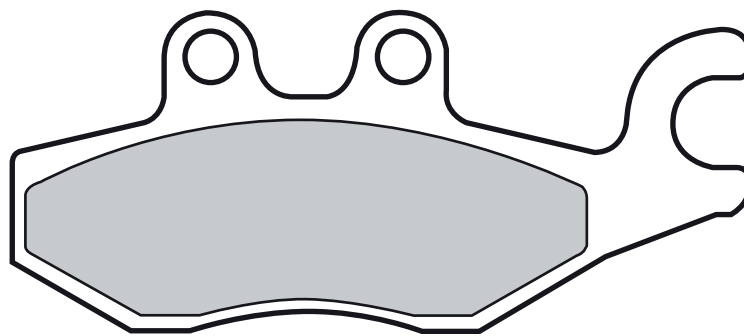
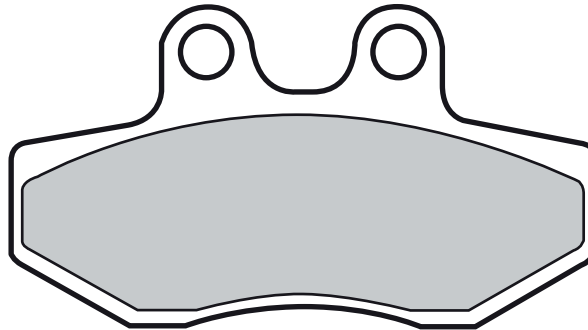
“ “ “

**PIAGGIO**

125	MEDLEY	16 >	•
125	MP3 HYBRID	10 >	•
125	X10 EXECUTIVE right	13 >	•
125	X9 PREMIUM EURO2	06 > 07	•
125	X9 right caliper	04 > 05	•
125	X9 right caliper	06 >	•
125	XEVO	08 >	•
150	MEDLEY	16 >	•

250	X EVO	08 >	•
250	X9 EVOLUTION right caliper	05 >	•
300	BEVERLY I.E.	11 >	•
300	MP3 LT I.E.	10 >	•
300	MP3 LT ie ABS	14 >	•
300	MP3 LT SPORT ABS	14 >	•
300	MP3 YOURBAN	15 >	•
300	X7 EVO I.E.	11 >	•
350	BEVERLY S	14 >	•

350	BEVERLY SPORT TOURING IE	12 >	•
350	BEVERLY SPORT TOURING IE ABS	12 >	•
350	X10 EXECUTIVE right	13 >	•
400	X EVO	08 >	•
400	X8 ie left caliper	06 >	•
500	MP3 SPORT	10 >	•
500	X10 EXECUTIVE right	13 >	•



**07061.CC** 55.1 x 54.1 x 7.7  
**07061.XS** “ “ “

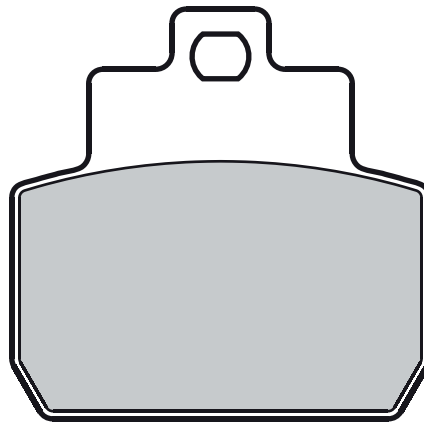

### PIAGGIO

125 MP3	06 > 08	•
125 MP3	09 >	•
125 MP3 IE	08 > 08	•
125 MP3 IE	09 > 09	•
125 X8	05 >	•

125 X9 left caliper	06 >	•
125 X9 PREMIUM EURO2	06 > 07	•
200 X8	05 >	•
250 BEVERLY	06 >	•
250 BEVERLY S	06 >	•
250 MP3	06 >	•

250 X8 I.E.	06 >	•
250 X9 EVOLUTION right caliper	05 >	•
400 MP3	07 >	•
400 MP3 LT	09 >	•
500 BEVERLY	05 >	•



**07062.CC** 70.2 x 42 x 8.1

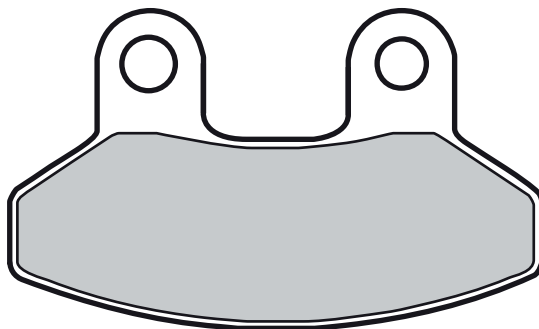

### LAVERDA

125 PHOENIX	01 >	•
150 PHOENIX	01 >	•
200 PHOENIX	01 >	•

### RIEJU

125 RS2 PRO	08 >	•
-------------	------	---

### SYM

50 RS	05 >	•
50 RS 21	02 >	•
50 SUPER FANCY	98 >	•
125 EURO MX	03 >	•
125 JOYRIDE	01 >	•
125 JOYRIDE EVO	10 >	•
125 JOYRIDE S	16 >	•

125 RS	05 >	•
125 RS 21, R	02 >	•
125 VS	06 >	•
150 EURO MX	03 >	•
150 JOYRIDE	01 >	•
150 RS	05 >	•
150 VS	06 >	•
200 JOYRIDE	01 >	•
200 JOYRIDE S	16 >	•



**07063.CC** 117.6 x 44.9 x 8.8

**07063.XS** “ “ “

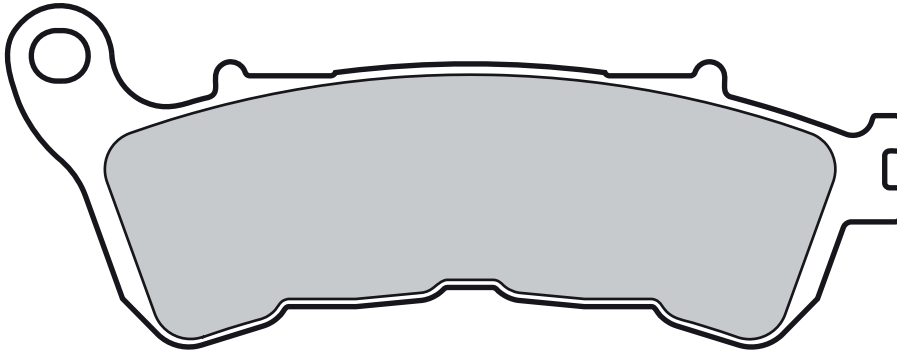

### HONDA

125 SH MODE	09 > 12	•
125 SILVERWING	08 >	•
150 SH	09 >	•
150 SILVER WING	08 >	•
250 FORZA	05 >	•
250 NSS JAZZ	05 >	•

300 FORZA ABS	14 >	•
300 SH I	07 >	•
400 SILVER WING	09 >	•
600 SW-T	11 >	•

### KYMCO

50 VITALITY	04 >	•
-------------	------	---

### SUZUKI

125 BURGMAN	07 >	•
125 SIXTEEN	08 >	•
150 SIXTEEN	08 >	•
200 BURGMAN	07 >	•



**07064.CC** 81.3 x 37.2 x 9

**07064.XS** “ “ “

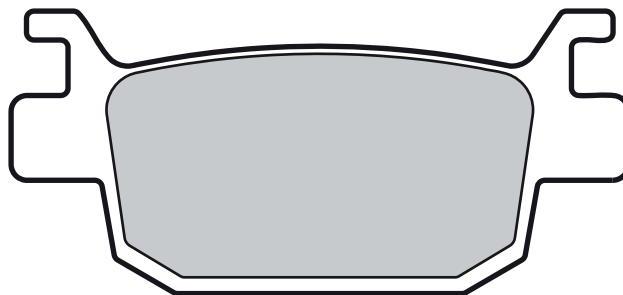

### HONDA

125 FORZA	15 >	•
125 SH MODE	09 > 12	•
125 SH MODE	13 >	•

150 SH	09 >	•
150 SH ABS	14 >	•
150 SILVER WING	08 >	•
250 FORZA	05 >	•
250 NSS JAZZ	05 >	•

300 FORZA ABS	14 >	•
300 SH 30 ANNI	15 >	•
300 SH I	07 >	•
300 SH I ABS	16 >	•



**07065.CC** 93.7 x 39.8 x 7.4

**07065.XS** “ “ “

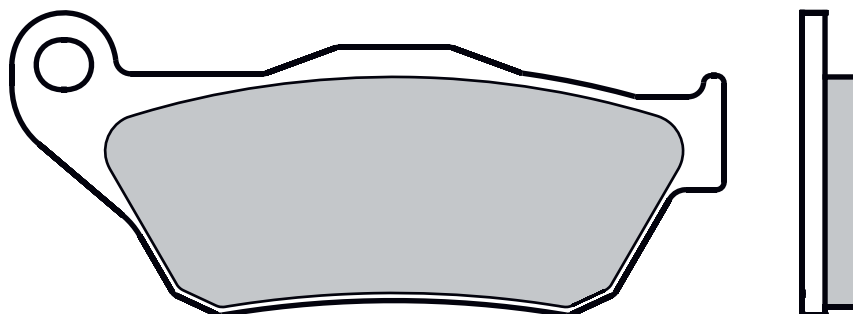

**MBK**

125 SKYCRUISER 06 > •

**YAMAHA**

125 X CITY 08 > •  
 125 X MAX 06 > 09 •  
 250 X MAX 06 > 09 •



**07066.CC** 45.2 x 52.5 x 6.3

**07066.18** “ “ “  
 GENUINE

**07066.23** “ “ “  
 GENUINE

**07066.XS** “ “ “

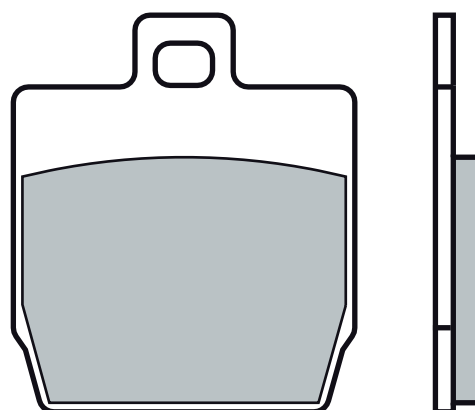

**MBK**

50 NITRO 97 > •  
 50 STUNT 00 > •  
 100 NITRO 00 > •

**YAMAHA**

50 AEROX 97 > 12 •  
 50 AEROX 13 > •  
 50 AEROX REPLICIA 97 > 06 •

50 AEROX ROSSI 04 > •  
 50 SLIDER 00 > •



<b>07067.CC</b>	35.3 x 48.8 x 6.2
<b>07067.XS</b>	“ “ “

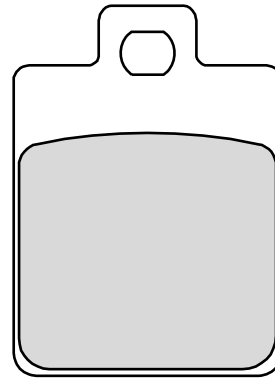

### GILERA

50	DT STALKER	97 >	•
50	RUNNER PURE JET	98 > 05	•
50	RUNNER PURE JET	06 >	•
50	RUNNER SP	98 > 05	•
50	RUNNER SP	06 >	•
50	STALKER	97 >	•
125	RUNNER FX (GRIMECA CALIPER)	00 >	•
125	RUNNER FX (HENGTONG CALIPER)	00 >	•
125	RUNNER FX SP (GRIMECA CALIPER)	00 >	•
125	RUNNER FX SP (HENGTONG CALIPER)	00 >	•
125	RUNNER ST	12 >	•
180	RUNNER FXR (GRIMECA CALIPER)	00 >	•
180	RUNNER FXR (HENGTONG CALIPER)	00 >	•
180	RUNNER FXR SP (GRIMECA CALIPER)	00 >	•
180	RUNNER FXR SP (HENGTONG CALIPER)	00 >	•

200	RUNNER FX SP	98 >	•
200	STALKER	97 >	•
500	FUOCO I.E.	08 >	•

### PEUGEOT

50	TWEET	10 > 12	•
50	TWEET PARIS	16 >	•
50	TWEET RS	10 > 12	•
125	TWEET PARIS	16 >	•
125	TWEET RS	10 > 12	•
150	TWEET PARIS	16 >	•
150	TWEET RS	10 > 12	•

### PIAGGIO

50	LIBERTY	97 >	•
50	LIBERTY 4T	00 > 15	•
50	VESPA ET2	97 >	•
50	VESPA ET4	00 >	•
50	VESPA LX 2T	05 >	•
50	VESPA LX 4T-4V	05 >	•
50	VESPA S 4T-4V	09 >	•
50	ZIP DISCO	96 >	•
50	ZIP FAST RIDER	96 >	•
50	ZIP SPORT H20 SP	96 >	•
50	ZIP SPORT RST	98 > 99	•

125	LIBERTY	99 >	•
125	LIBERTY 4T	06 > 07	•
125	LIBERTY 4T EURO3	07 > 08	•
125	MP3	06 > 08	•
125	MP3 IE	08 > 08	•
125	SFERA	95 >	•
125	SKIPPER 4T	07 >	•
125	VESPA 70 PX	16 >	•
125	VESPA ET4	96 >	•
125	VESPA LX 4T	05 >	•
125	VESPA PX	02 > 07	•
125	VESPA PX 30 ANNI	07 > 07	•
125	ZIP 4T	00 >	•
150	LIBERTY	99 >	•
150	VESPA 70 PX	16 >	•
150	VESPA ET4	02 >	•
150	VESPA PX	02 > 07	•
200	LIBERTY	06 >	•
200	LIBERTY S	06 >	•
200	VESPA PX	02 > 07	•
250	MP3	06 >	•
250	VESPA LX 60	06 >	•
300	MP3 YOURBAN	15 >	•
400	MP3	07 >	•
400	MP3 LT	09 >	•



**07068.CC** 76.7 x 41.9 x 9.5

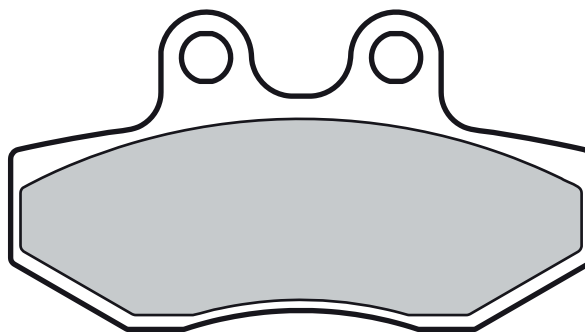

**MBK**

125 FLAME X 05 > •

**YAMAHA**

125 CYGNUS X 05 > 09 •



**07069.CC** 93.6 x 35.8 x 10.1

**07069.XS** “ “ “

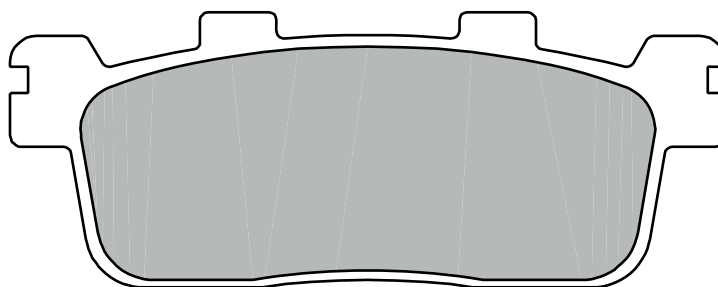

**DAELIM**

250 ST SECTOR QUAD 05 > 06 •

**E-TON**

150 RXL VIPER 07 > •  
 250 ST VECTOR 06 > •  
 250 VXL VECTOR 06 > •  
 300 ST VORTEX 07 > •  
 300 VTX VORTEX 07 > •  
 300 VXL VECTOR, ST VECTOR 07 > •

**KYMCO**

125 G-DINK 12 > •  
 125 KXCTI 14 > •  
 125 PEOPLE GTI 10 > 11 •  
 125 PEOPLE S 06 > •  
 200 PEOPLE S 05 > •  
 250 PEOPLE S left caliper 06 > •  
 250 XCITING 05 > •  
 300 G-DINK 12 > •  
 300 K-XCTI 12 > •  
 300 PEOPLE GTI 10 > 11 •

300 PEOPLE S 08 > 10 •  
 300 PEOPLE SI left caliper 08 > •  
 300 XCITING R 08 > 11 •  
 300 XCITING RI 08 > •

**SYM**

125 SB WOLF 11 > •  
 250 QUADLANDER 06 > •  
 300 CITY MAX 06 > •





**07070.CC**

62 x 40.7 x 9.5  
82.2 x 40.7 x 9.5

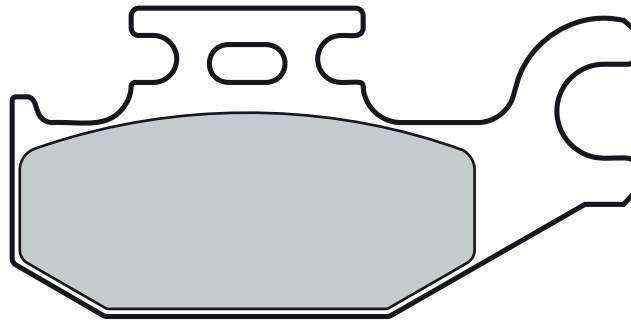
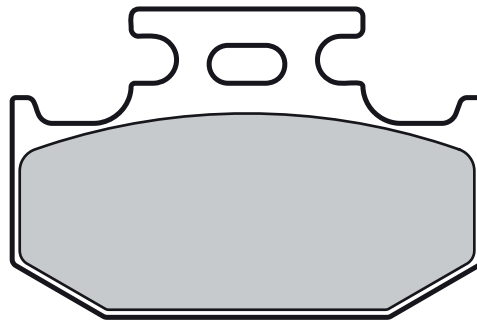

**SUZUKI**

125	BURGMAN	07 >	•
125	SIXTEEN	08 >	•
150	SIXTEEN	08 >	•
200	BURGMAN	07 >	•



**07071.CC**

76.9 x 41.9 x 8

96.6 x 41.9 x 8

**07071.XS**

“ “ “

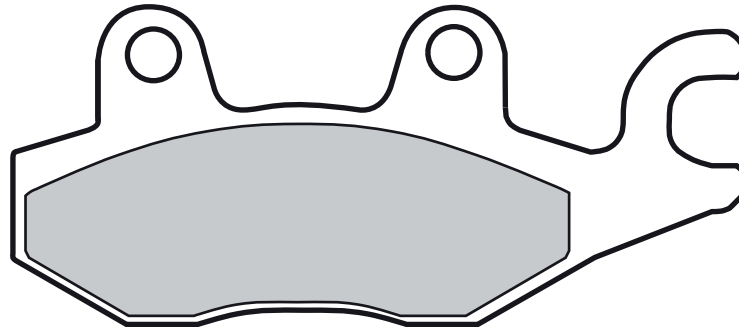
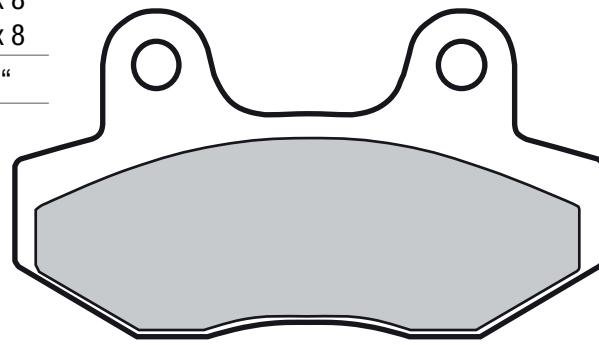

**SUZUKI**

400 BURGMAN

06 >



**07072.CC**

115 x 40.1 x 8.3

**07072.XS**

“ “ “

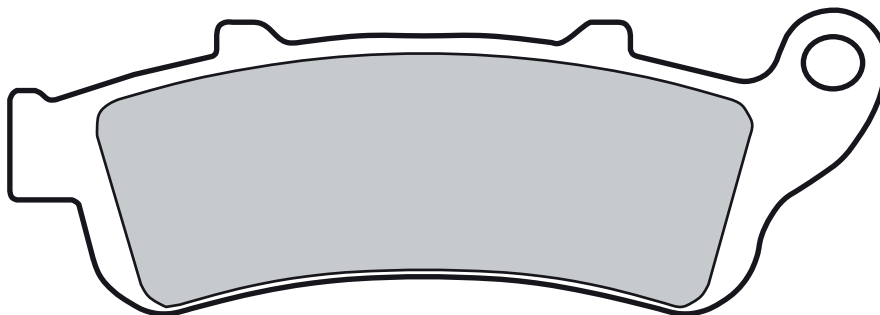

**HONDA**

400 SILVER WING

06 > 08

600 SILVER WING

00 >

600 SILVER WING ABS

03 >

**PEUGEOT**

50 CITYSTAR

14 >



**07073.CC**

102 x 40.4 x 10

**07073.XS**

“ “ “

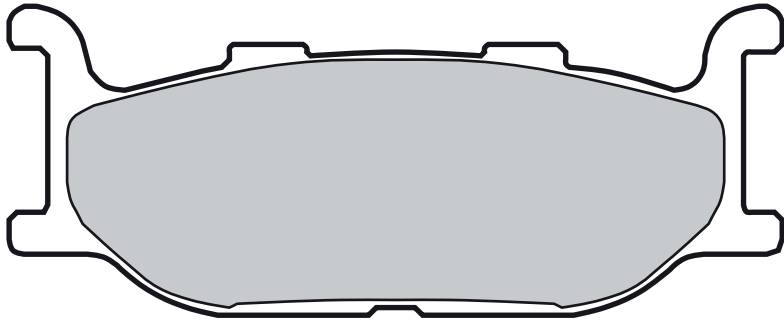

**YAMAHA**

400 MAJESTY	04 > 04	•
500 T MAX	01 > 03	•

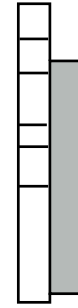
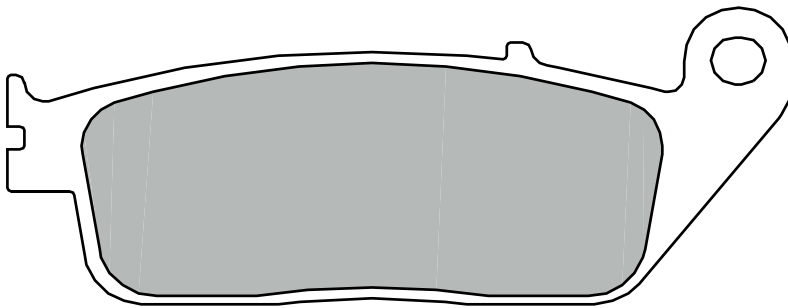
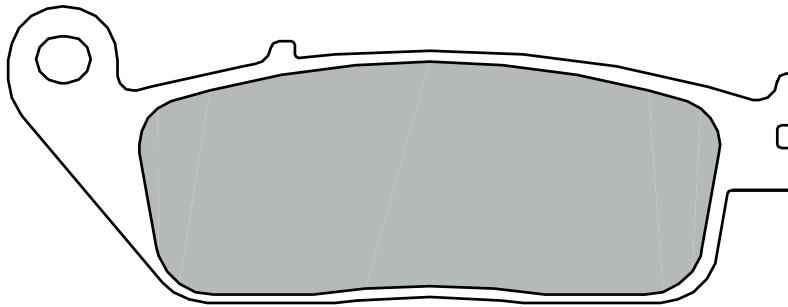

**07074.CC** 102.1 x 38.9 x 8.1**07074.XS** “ “ “**BMW**

600 C 600 SPORT	12 >	• •
650 C 650 GT	12 >	• •

**HONDA**

125 FORZA	15 >	•
250 CN HELIX	93 >	•
300 SH 30 ANNI	15 >	•
300 SH I ABS	16 >	•

**HYOSUNG**

125 V2	99 >	•
--------	------	---

**KAWASAKI**

125 J125	16 >	•
300 J	14 >	•

**KYMCO**

125 DOWNTOWN	10 >	•
--------------	------	---

125 G-DINK	12 >	•
200 DOWNTOWN	10 >	•
250 XCITING	05 >	•
300 DOWNTOWN I	10 >	•
300 DOWNTOWN I ABS	10 > 12	•
300 G-DINK	12 >	•
300 PEOPLE GTI	10 > 11	•
300 XCITING R	08 > 11	•
300 XCITING RI	08 >	•

**PEUGEOT**

50 DJANGO HERITAGE	14 >	•
125 DJANGO HERITAGE	14 >	•
125 SATELIS ABS	04 >	•
150 DJANGO HERITAGE	14 >	•
250 SATELIS RS	11 >	•
300 GEOPOLIS GT	14 >	•
300 GEOPOLIS PREMIUM (nissin caliper)	10 >	•
400 GEOPOLIS	08 >	•

400 GEOPOLIS GT	14 >	•
400 GEOPOLIS RS	08 >	•
400 SATELIS	07 >	•
400 SATELIS RS	07 >	•
500 GEOPOLIS	08 >	•
500 GEOPOLIS RS	08 >	•
500 SATELIS	06 >	• •
500 SATELIS RS	07 >	•
600 SATELIS ABS	04 >	•

**SUZUKI**

650 BURGMAN	02 >	•
650 BURGMAN EXECUTIVE	04 >	•
650 BURGMAN EXECUTIVE	13 >	•

**YAMAHA**

300 XC VERSITY	05 >	•
----------------	------	---



**07075.XS** 102.1 x 38.9 x 8.9

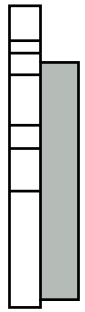
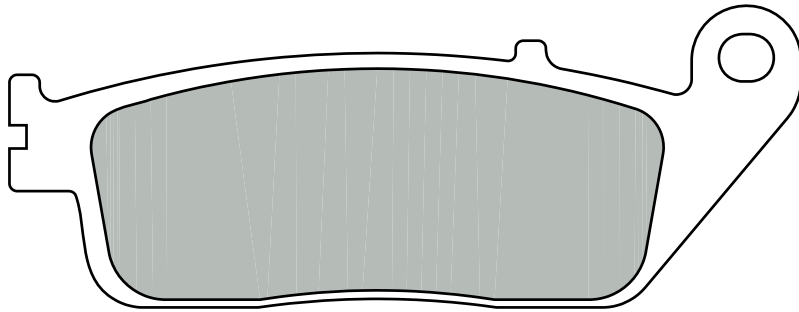
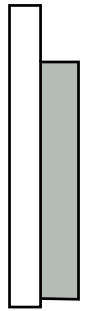
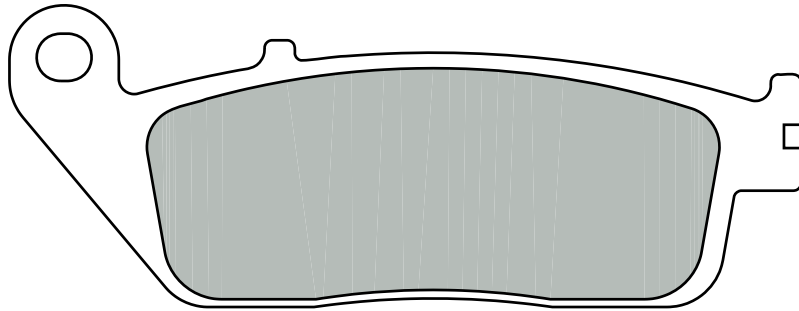

### HONDA

400	SILVER WING	06 > 08	•
400	SILVER WING	09 >	•
600	SILVER WING	00 >	•
600	SILVER WING ABS	03 >	•
600	SW-T	11 >	•

### KYMCO

500	XCITING	05 >	•
500	XCITING AF1 ABS	06 >	• •
500	XCITING I EVO ABS	11 >	•
500	XCITING R ABS	09 >	•
700	MY ROAD	09 >	•
700	XCITING R	09 >	• •

**07076.CC**

 76.9 x 41.9 x 8  
 96.6 x 41.9 x 8

**07076.XS**

“ “ “

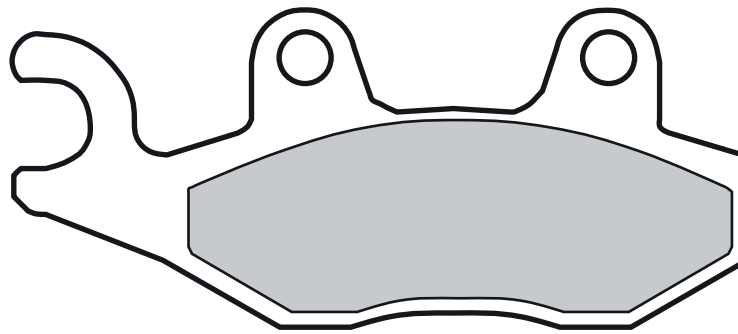
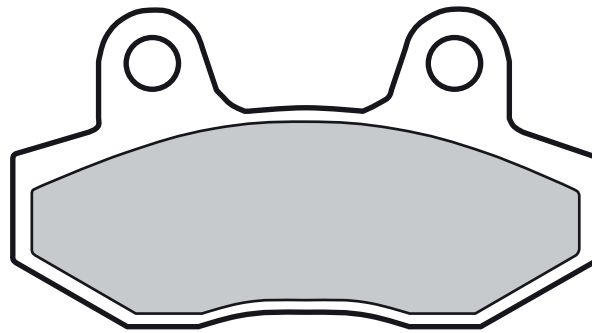
**APRILIA**

50 SX 14 &gt; •

**BENELLI**

125 MACIS 10 &gt; • •

150 MACIS 10 &gt; • •

**GARELLI**

200 XO 12 &gt; •

**PEUGEOT**

125 GEO RS 08 &gt; • •

125 SATELIS SPORT 11 &gt; • •

125 VIVACITY 10 &gt; •

250 GEO RS 08 &gt; • •

300 GEOPOLIS GT 14 &gt; •

300 GEOPOLIS PREMIUM (nissin caliper) 10 &gt; •

300 GEOPOLIS RS 13 &gt; • •

300 GEOPOLIS RS (NISSIN CAL.) 10 &gt; • •

300 GEOSTYLE 10 &gt; • •

300 SATELIS 13 &gt; • •

400 GEOPOLIS GT 14 &gt; •

400 GEOPOLIS RS 08 &gt; •

400 SATELIS 07 &gt; •

400 SATELIS RS 07 &gt; •

500 GEOPOLIS 08 &gt; •

500 GEOPOLIS RS 08 &gt; •

500 SATELIS RS 07 &gt; •

**SUZUKI**

400 BURGMAN 07 &gt; •

**07077.CC**

69.2 x 51.3 x 8.8

**07077.XS**

“ “ “

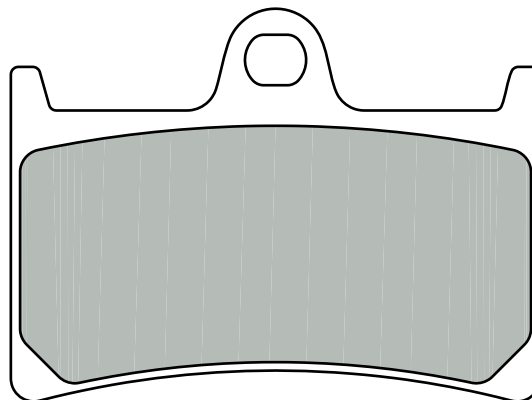
**YAMAHA**

500 T MAX 08 &gt; 11 •

530 T MAX 12 &gt; •

530 T MAX IRON MAX 15 &gt; •

530 T MAX LUX MAX 16 &gt; •



**07078.CC** 80.9 x 41.7 x 7.3

**07078.XS** " " "

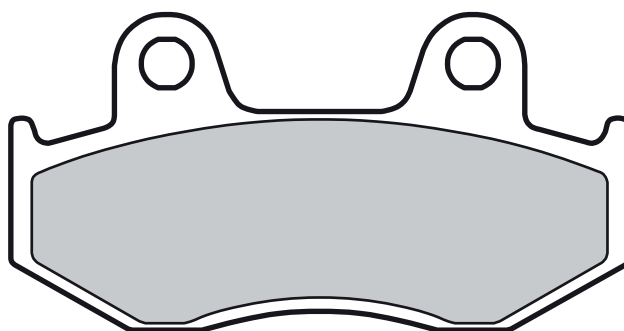

### HONDA

110 NHX	10 >	•
125 CH SPACY	94 >	•
150 SH	01 > 08	•
250 CH SPACY	85 >	•



**07080.CC** 76.9 x 41.9 x 7.5

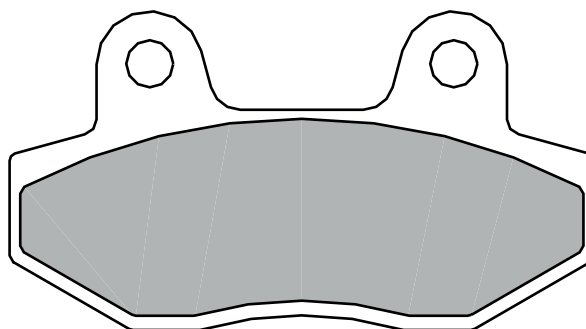

### GARELLI

XO ELETTRIC	12 >	•
125 FLEXI	12 >	•
125 XO	12 >	•
150 XO	12 >	•

### KEEWAY

50 RY 8	10 >	•
---------	------	---

### KYMCO

50 NEXXON	08 >	• •
125 NEXXON	08 >	• •
150 STRAIGHT	08 >	• •

### PEUGEOT

50 SPEEDFIGHT 3	10 >	•
50 SPEEDFIGHT 3 LC, LC RS	10 >	•
50 SPEEDFIGHT TOTAL SPORT	16 >	•



**07081.35**  
GENUINE

39.8 x 56.2 x 6.8

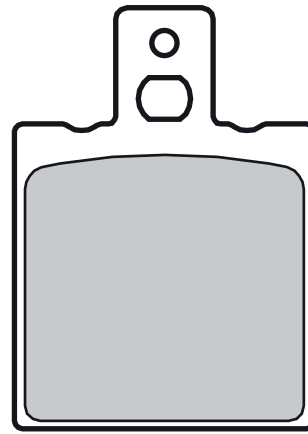

**BETA**

50	CHRONO 502	97 >	•
50	QUADRA	97 >	•

**CAGIVA**

50	COCIS	88 > 88	•
50	CUCCIOLO	97 >	•

50	NUVOLA	00 >	•
125	CUCCIOLO	00 >	•
125	NUVOLA	00 >	•

**DERBI**

50	EASY	96 >	•
----	------	------	---

**PGO**

50	G-MAX DOPPLER	06 >	•
----	---------------	------	---

**SIMSON**

50	STAR	99 >	•
----	------	------	---



**07082.25**  
GENUINE

77.9 x 41.2 x 9

**07082.30**  
GENUINE

“ “ “

**07082.35**  
GENUINE

“ “ “

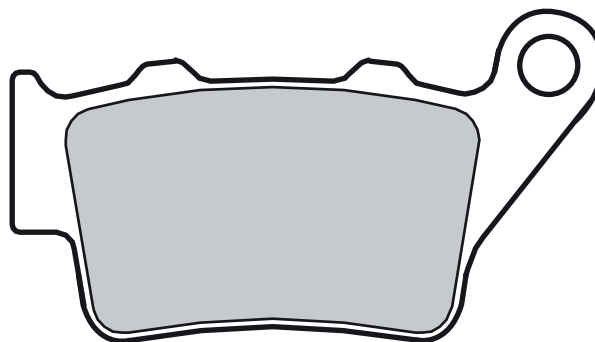

**BMW**

125	C 1	99 > 02	•
125	C 1 EXECUTIVE	00 >	•
125	C 1 FRIENDS	01 >	•
200	C 1	01 >	•
200	C 1 EXECUTIVE	01 >	•
200	C 1 FRIENDS	01 >	•





**07083.35**  
GENUINE 108.5 x 40.1 x 7.6

**07083.59**  
GENUINE “ “ “

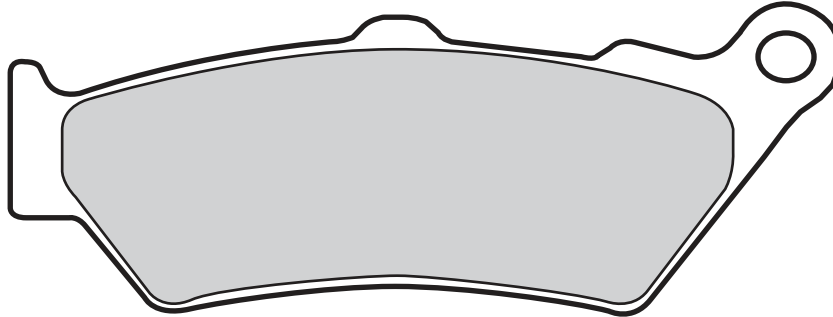

**BMW**

125 C 1 99 > 02 •

125 C 1 EXECUTIVE

125 C 1 FRIENDS

200 C 1

00 > •

01 > •

01 > •

200 C 1 EXECUTIVE

200 C 1 FRIENDS

01 > •

01 > •



**07084.24**  
GENUINE 35.8 x 51.6 x 5.9

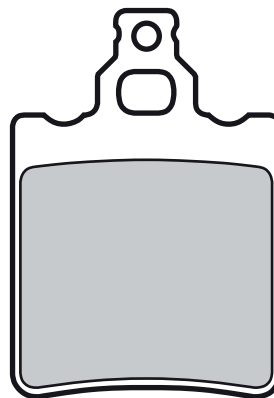

**APRILIA**

125 LEONARDO 96 > 96 •

**CAGIVA**

50 COCIS 88 > 88 •

**KYMCO**

125 FREEWAY 93 > 95 •



**07085.CC** 90 x 33.3 x 9.8

**07085.XS** " " "

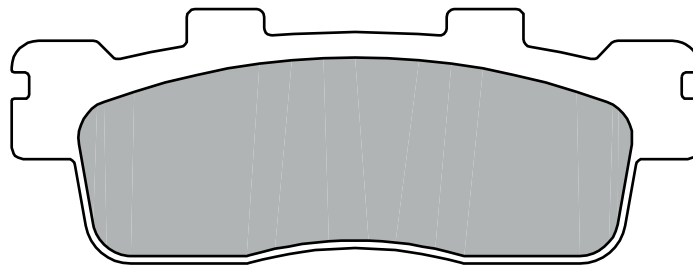

### KAWASAKI

125 J125	16 >	•
300 J	14 >	•

### KYMCO

125 DOWNTOWN	10 >	•
125 DOWNTOWN I ABS	16 >	•
125 PEOPLE GTI	12 >	•
125 SUPER DINK	10 >	• •
125 XTOWN I ABS	16 >	•



200 DOWNTOWN	10 >	•
200 PEOPLE GTI	12 >	•
300 DOWNTOWN I	10 >	•
300 DOWNTOWN I ABS	10 > 12	•
300 PEOPLE GTI	12 >	•
300 XTOWN I ABS	16 >	•



**07086.CC** 39.7 x 54 x 6.6

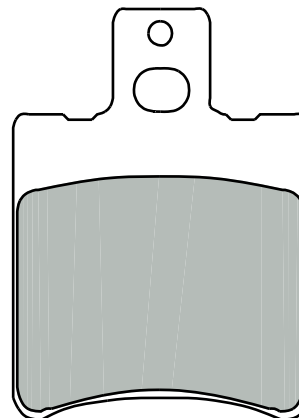

### APRILIA

50 SR EUROPA	93 >	•
50 SR URBAN KID	93 >	•

50 FORTE	94 >	•
50 OVETTO	97 >	•
80 EVOLIS	94 >	•



### SUZUKI

50 AP	95 > 97	•
50 KATANA -AY	96 >	•



### ATALA

50 BYTE	97 > 00	•
50 BYTE AT 10	97 >	•
50 SKEGGIA	98 >	•

### PGO

50 RODO SHOW	01 >	•
90 RODO SHOW	02 >	•

### PIAGGIO

50 ZIP & ZIP	94 >	•
--------------	------	---

### YAMAHA

50 AEROX	13 >	•
50 BREEZE	94 >	•
50 JOG-Z	90 >	•
50 YE ZEST	92 >	•
50 YH	98 >	•
80 YE ZEST	93 >	•

### MBK

50 BOOSTER N.G.	97 >	•
50 EQUALIS	96 >	•
50 EVOLIS	92 >	•
50 FIZZ	93 >	•

### SHE-LUNG

50 RACER	96 >	•
----------	------	---

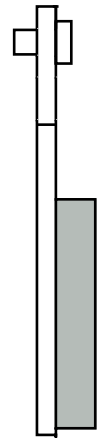
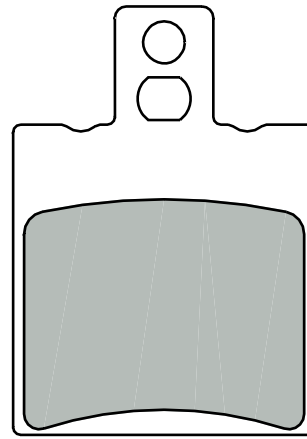

**07087.CC** 39.6 x 56.2 x 7.7

**APRILIA**

50	SR NETSCAPER	97 >	•
50	SR WWW	97 >	•
125	LEONARDO	97 > 98	•
150	LEONARDO	97 > 98	•

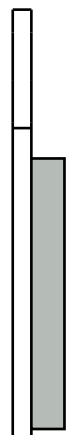
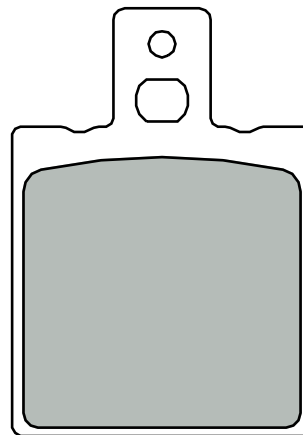

**07088.CC** 39.9 x 56.2 x 7

**BENELLI**

125	VELVET	99 > 04	•
125	VELVET TOURING	01 >	•
150	VELVET	00 > 04	•
150	VELVET TOURING	01 >	•
250	VELVET	99 >	•
250	VELVET TOURING	01 >	•



**07089.CC** 76.7 x 41.9 x 7.3

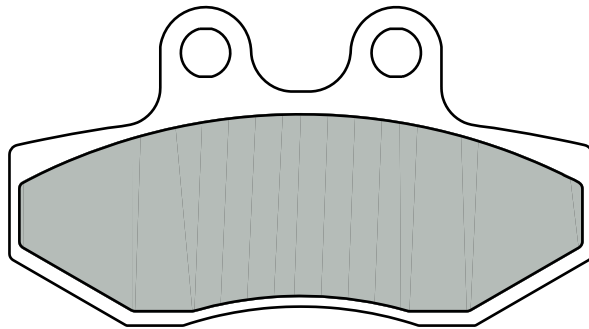

**APRILIA**

50	RX	06 >	•
50	SX	06 > 13	•



**07090.CC**

109.1 x 41.1 x 8

111.1 x 44.3 x 8

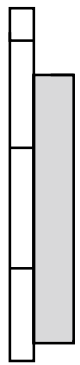
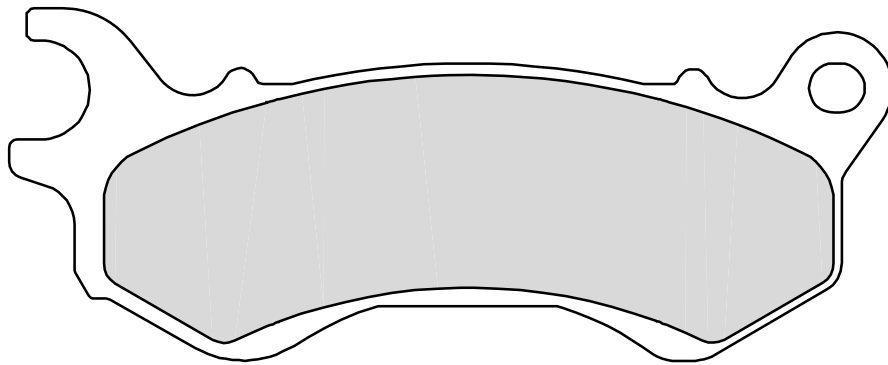
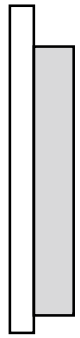
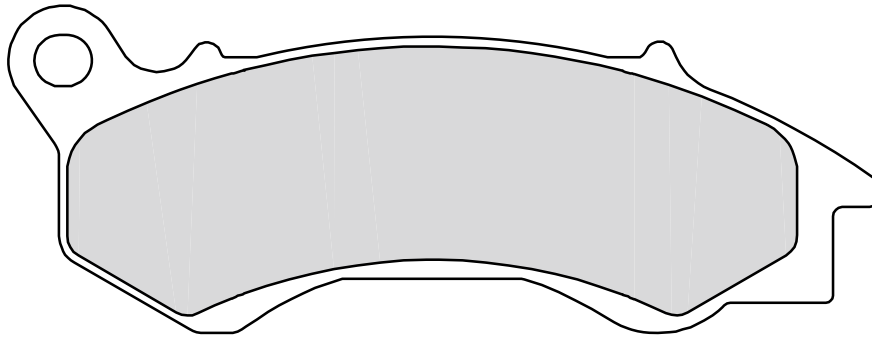

**HONDA**

50	NSC	10 >	•
110	LEAD	10 > 11	•
110	NSC	10 >	•
125	PCX	09 >	•



**07091.CC**

76.5 x 40.1 x 9  
98.9 x 40.5 x 8.1

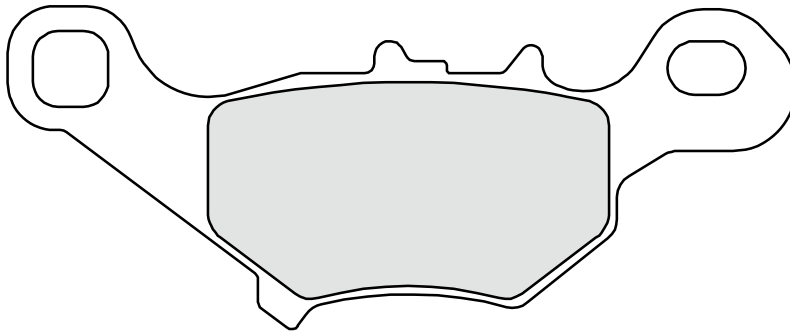
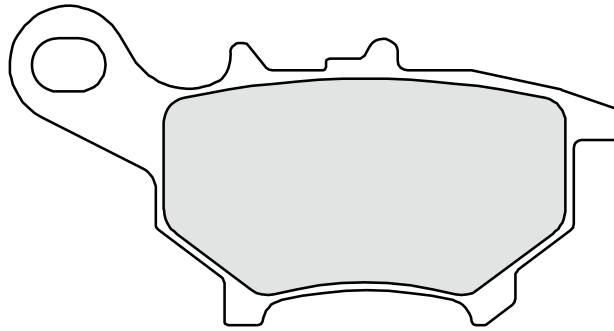

**YAMAHA**

50 CV A/R JOG 03 > 08 •



0821 000 555



0821 000 777



+33 3 89 70 3000



+33 3 89 70 30 99



**07092.CC**

90 x 39 x 10.3

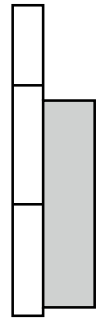
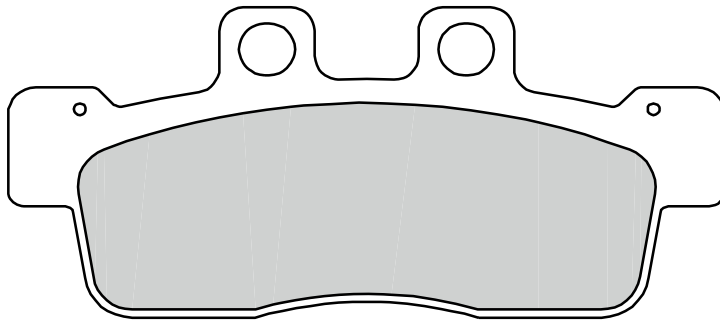

**YAMAHA**

125 CYGNUS	11 >	•
125 CYGNUS NXC	10 >	•



**07093.CC** 108.9 x 50.6 x 9.8  
113 x 41.4 x 9

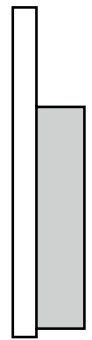
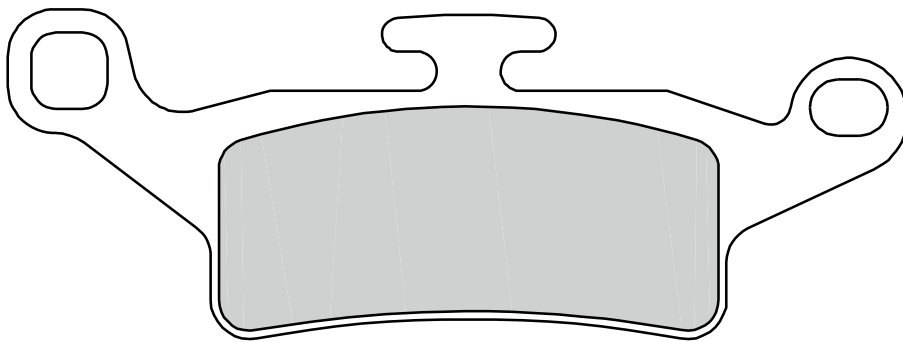
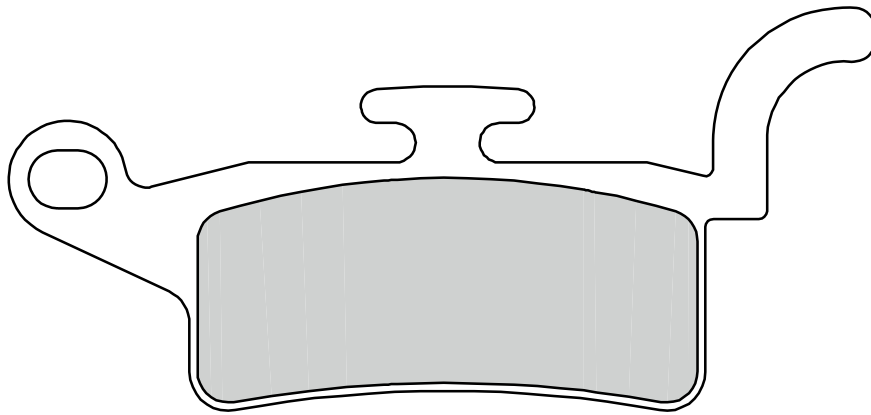

**HONDA**

250 RECON 97 > •



**MBK**

125 YW Z 10 > •



**YAMAHA**

125 BWS	10 > •
125 XENTER	12 > •
125 YW	10 > •
125 YW Z	10 > •
150 XENTER	12 > •





**07094.CC** 40.9 x 42.8 x 5.3

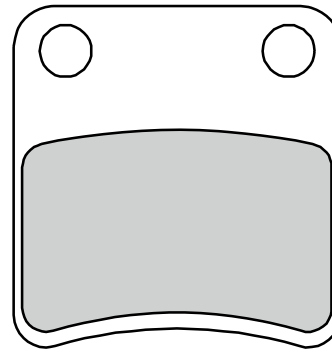

### APRILIA

850 SRV PARKING BRAKE 12 > •

### BMW

560 C 650 GT PARKING BRAKE 12 > •

600 C 600 SPORT PARKING BRAKE 12 > •

### GILERA

500 FUOCO I.E. (PARKING BRAKE) 08 > •

800 GP800 (PARKING BRAKE) 09 > •

### HONDA

400 SILVER WING (PARKING BRAKE) 06 > •

600 SILVER WING (PARKING BRAKE) 00 > •

750 INTEGRA DCT/DCTS parking brake 14 > •

### PIAGGIO

125 MP3 (PARKING BRAKE) 06 > •

250 MP3 (PARKING BRAKE) 06 > •

300 MP3 LT I.E. PARKING BRAKE 10 > •

300 MP3 YOURBAN ie parking brake 15 > •

350 X10 EXECUTIVE (PARKING BRAKE) 13 > •

400 MP3 LT PARKING BRAKE 09 > •

400 MP3 PARKING BRAKE 07 > •

500 MP3 SPORT PARKING BRAKE 10 > •

500 X10 12 > •

500 X10 EXECUTIVE (PARKING BRAKE) 13 > •



<b>07095.CC</b>	76.9 x 41.9 x 9.3
	116.3 x 41.9 x 9.3

<b>07095.XS</b>	“ “ “
-----------------	-------

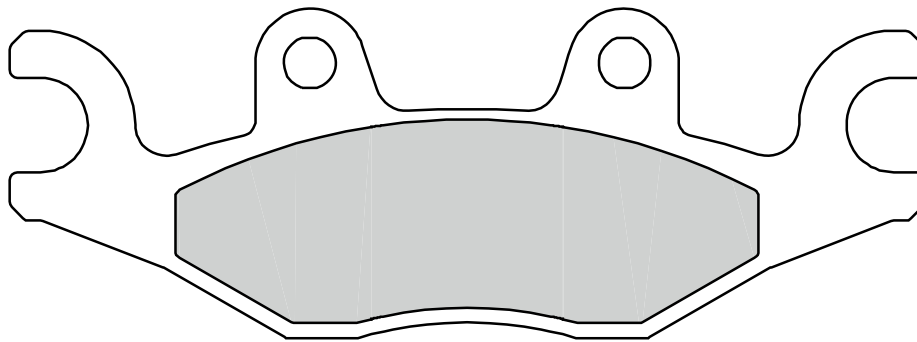
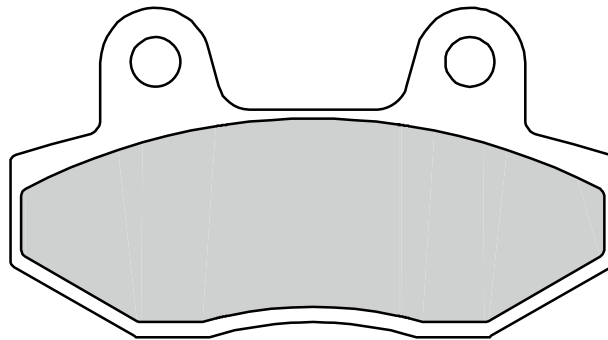

**TGB**

125 X-LARGE	11 >	•
125 X-MOTION	08 >	•
250 X-MOTION	08 >	•
300 X-MOTION	11 >	•



**07096.CC** 102.1 x 38.9 x 10.4

**07096.XS** " " "

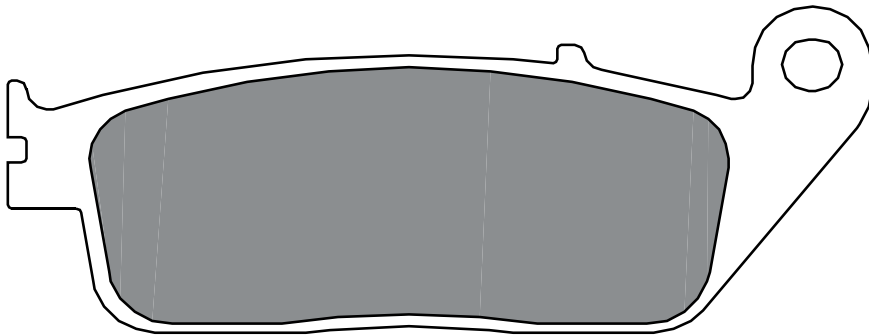
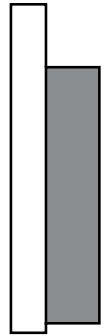
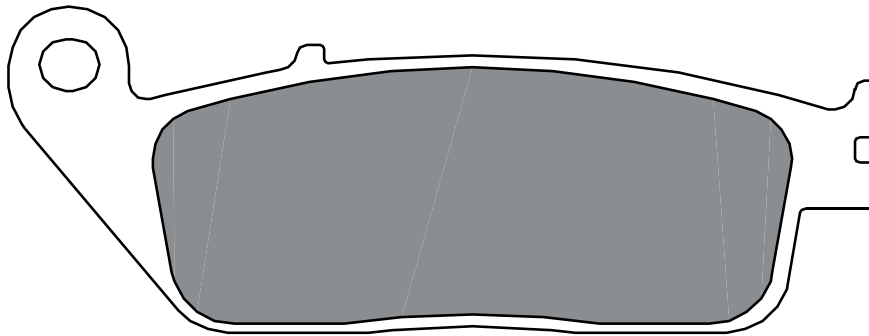

### HONDA

125 SH MODE	13 >	•
150 SH ABS	14 >	•

### YAMAHA

125 X MAX	10 >	•
-----------	------	---

125 X MAX ABS/ BUSINESS ABS	11 >	•
125 X MAX IRON MAX	16 >	•
125 X MAX MOMODESIGN	15 >	•
125 X MAX SPORT EDITION	11 >	•
250 X MAX	10 > 13	•
250 X MAX	14 >	•

250 X MAX ABS	11 > 13	•
250 X MAX IRON MAX	16 >	•
250 X MAX MOMODESIGN	16 >	•
250 X-CITY	08 >	•
400 X MAX	13 >	•
400 X MAX ABS	13 >	•
400 X MAX IRON MAX	16 >	•



**07097.CC** 57.7 x 33.2 x 6.1

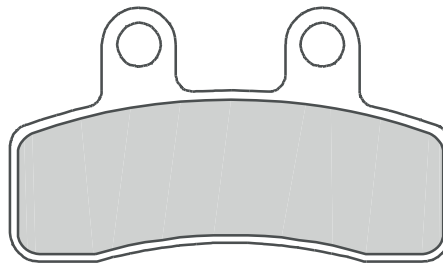

**GENERIC**

50	SM MINI TRIGGER	08 >	• •
50	X MINI TRIGGER	08 >	• •

**ITALJET**

50	PIT JET	07 >	• •
125	PIT JET	07 >	• •

**LIFAN**

125	LF OFF ROAD	07 >	•
-----	-------------	------	---

**LAMBRETTA**

50	PATO	08 >	•
----	------	------	---

**MOTO MORINI**

50	SPASSO	07 >	•
----	--------	------	---



**07098.CC** 102.1 x 38.9 x 8.5

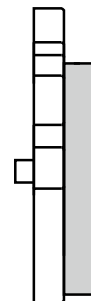
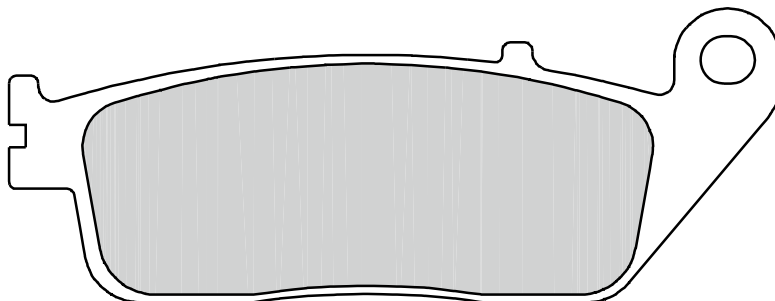
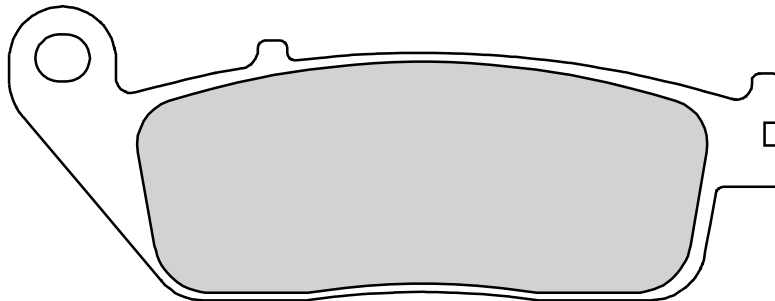

**KYMCO**

400	XCITING	12 >	•
-----	---------	------	---

400	XCITING 400I ABS	16 >	•
400	XCITING I	12 >	•
500	XCITING	05 >	•

500	XCITING I EVO ABS	11 >	•
500	XCITING R ABS	09 >	•
700	MY ROAD	09 >	•



**07099.CC**

73.7 x 36.2 x 7  
37.6 x 31.7 x 9

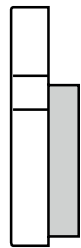
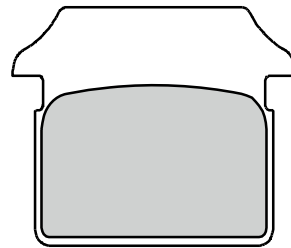
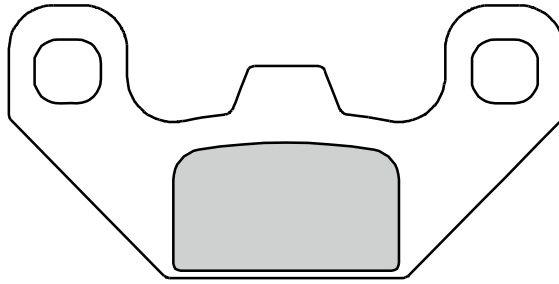

**LIFAN**

125 LF OFF ROAD 07 > •



**07100.CC**

68.3 x 55.3 x 9.2

**07100.XS**

“ “ “

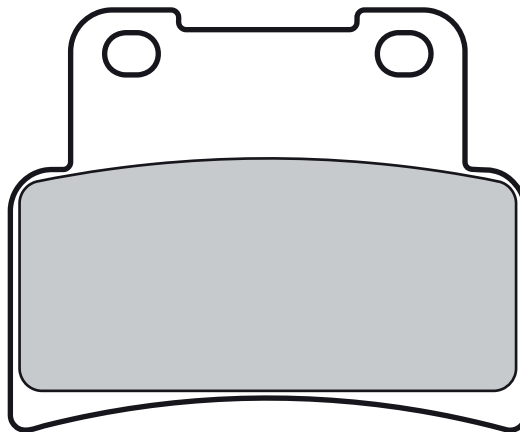

**KYMCO**

400 XCITING 12 > •  
400 XCITING 400I ABS 16 > •  
400 XCITING I 12 > •

**SYM**

400 I MAXSYM 11 > •



<b>07101.CC</b>	72.4 x 53.1 x 8
<b>07101.XS</b>	“ “ “

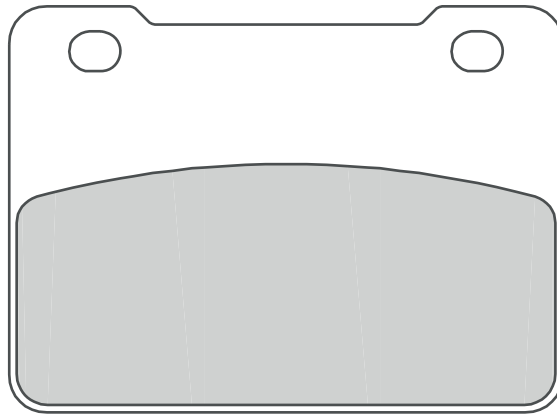

**SYM**

250 SB	14 >	•
250 SB NI	14 >	•
300 SB CAFE' RACER	16 >	•



**07102.CC**

84.9 x 44.1 x 7  
74.5 x 40.9 x 7

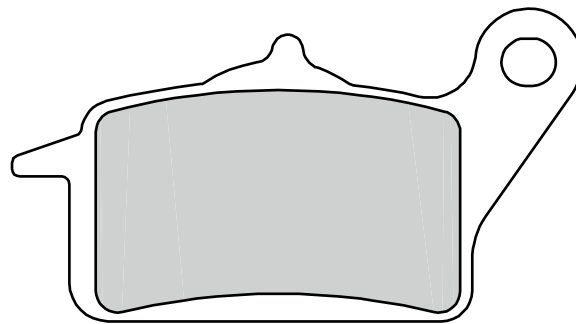
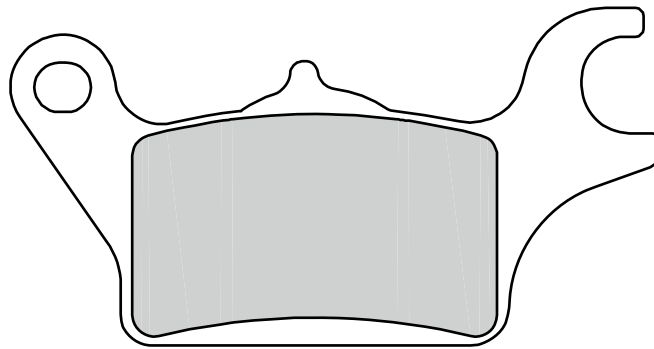

**HONDA**

110 WAVE

12 > •



0821 000 555



0821 000 777



+33 3 89 70 3000



+33 3 89 70 30 99



**07103.CC** 82.8 x 47.4 x 11.8

**07103.XS** " " "

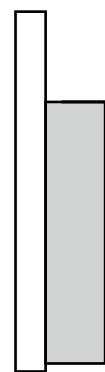
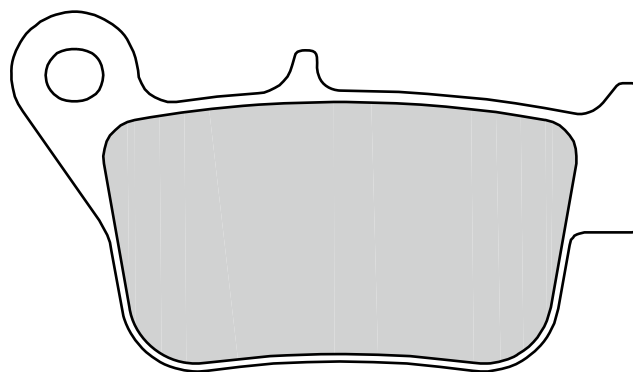
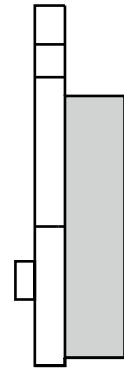
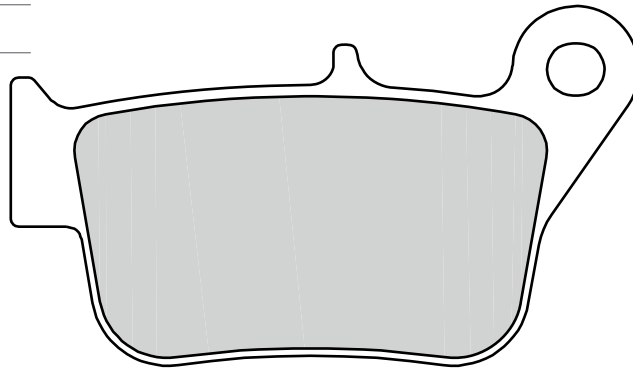

**SYM**

400 | MAXSYM 11 > •



**07104.XS** 97 x 39.6 x 7

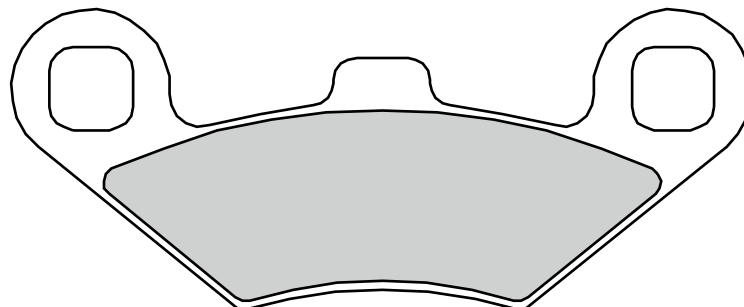

**PEUGEOT**

400 METROPOLIS 15 > • •  
 400 METROPOLIS RS 16 > • •





**07106.CC**

59.7 x 43.7 x 9.5

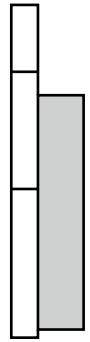
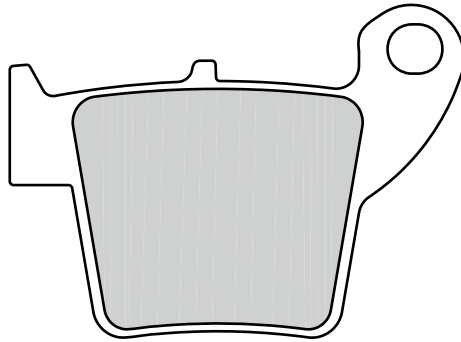
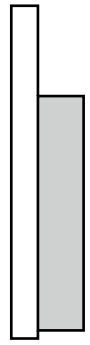
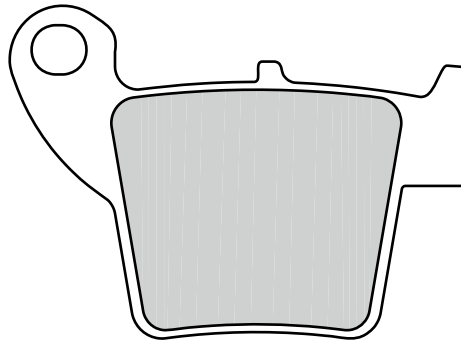

**FANTIC MOTOR**

50	CABALLERO MOTARD	10 >	•
50	CABALLERO REGOLARITÀ	10 >	•



0821 000 555



0821 000 777



+33 3 89 70 3000



+33 3 89 70 30 99



**07107.CC**

93.9 x 32.7 x 8

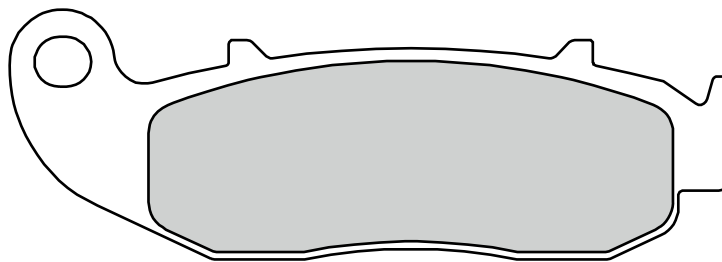
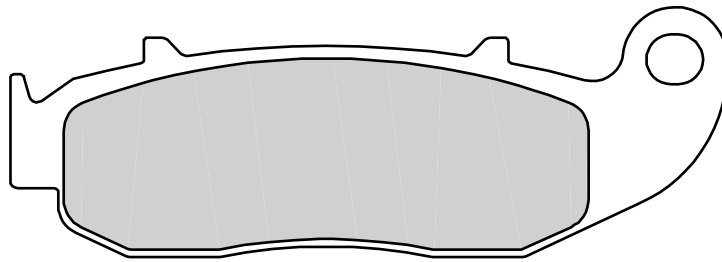

**FANTIC MOTOR**

50	CABALLERO MOTARD	10 >	•
	CABALLERO		
50	REGOLARITÀ	10 >	•



**07108.CC** 55.4 x 49.4 x 6.6  
**07108.XS** " " "

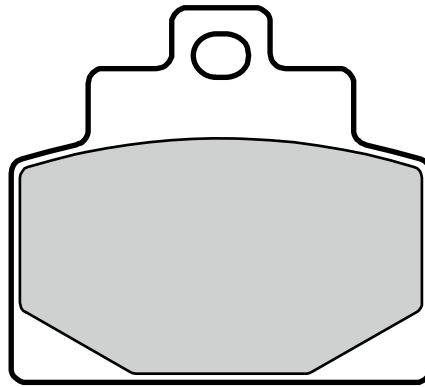

**PIAGGIO**

300 MP3 LT IE ABS 14 > •

300 MP3 LT SPORT ABS 14 > •  
 500 MP3 LT TOURING BUSINESS ABS 14 > •

500 MP3 LT TOURING SPORT ABS 14 > •



**07109.CC** 79.9 x 43.7 x 8.4  
**07109.XS** " " "

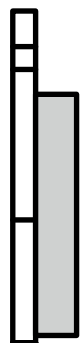
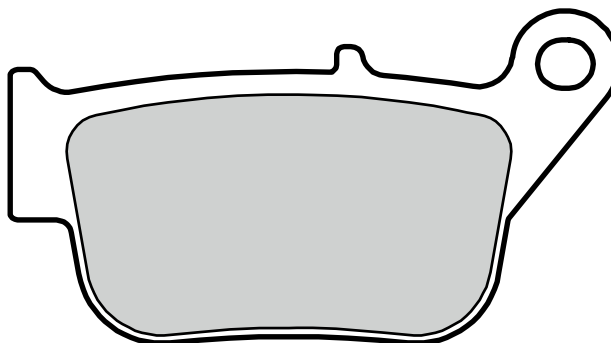
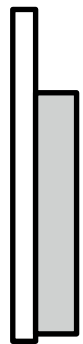
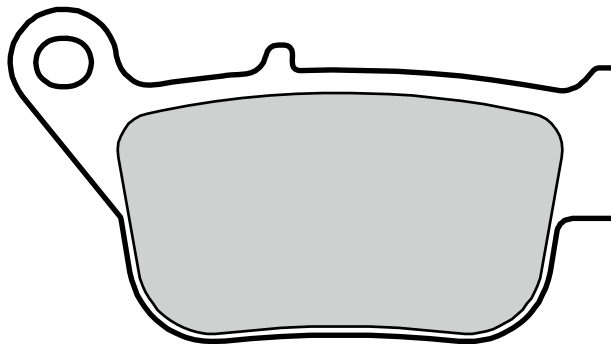

**YAMAHA**

250 X MAX 14 > •



**07110.CC**

106.7 x 42.4 x 10

91.4 x 39.8 x 10

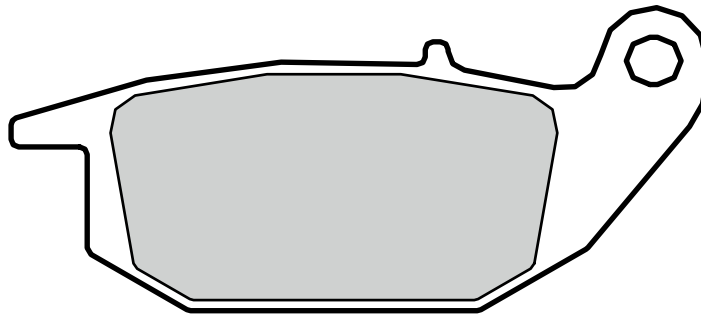
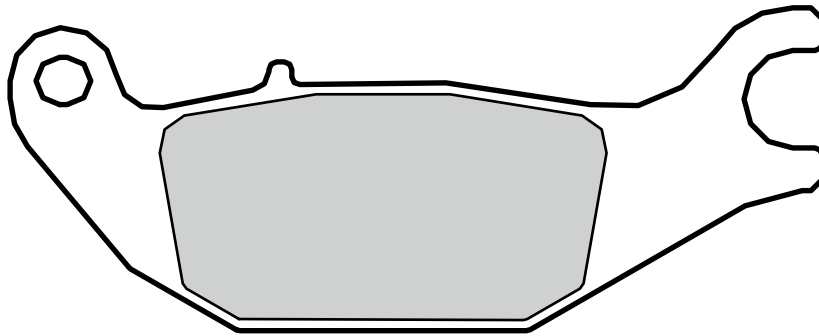

**YAMAHA**

125 TRICITY LEFT	14 >	•
125 TRICITY RIGHT	14 >	•





**07111.CC**

84.9 x 44.1 x 9  
74.2 x 40.6 x 9

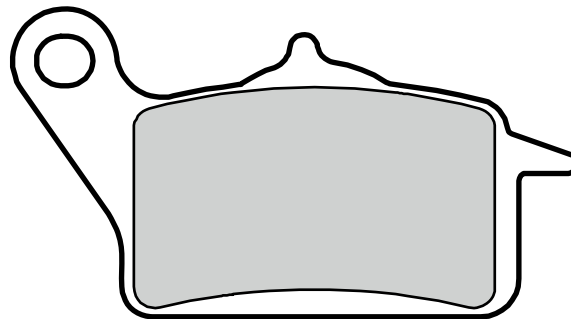
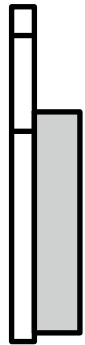
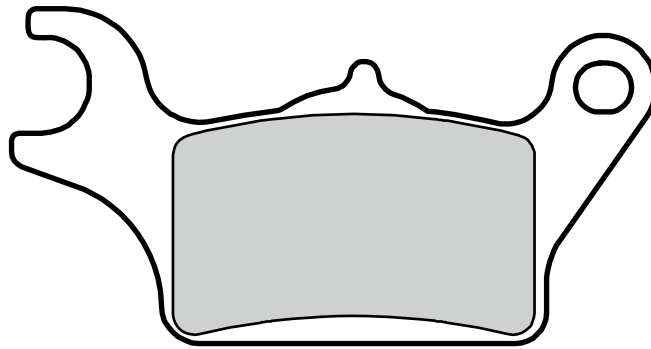

**YAMAHA**

125 TRICITY RIGHT

14 > •



0821 000 555



0821 000 777



**DOM  
TOM**



+33 3 89 70 3000



+33 3 89 70 30 99



**07112.CC**

84.9 x 44.1 x 9  
74.2 x 40.6 x 9

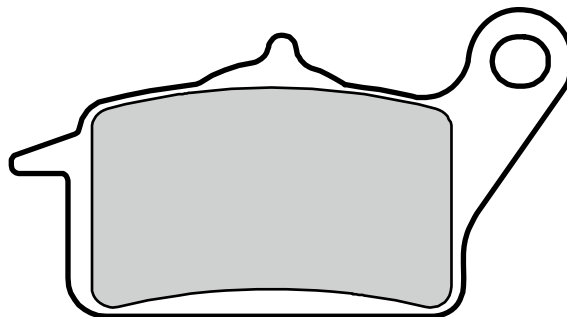
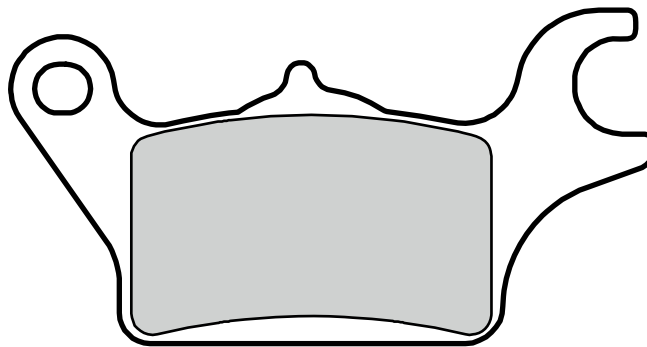

**YAMAHA**

125 TRICITY LEFT

14 >



0821 000 555



0821 000 777



DOM  
TOM



+33 3 89 70 3000



+33 3 89 70 30 99