

R 2

R 2

P 2



2018



**brenta**

brake evolution





brenta®  
> brake evolution <<

The Brenta logo features a stylized icon above the brand name. The icon is composed of a grey shape resembling a car's front end and a red shape resembling a brake disc. The brand name 'brenta' is in a lowercase, sans-serif font with a registered trademark symbol. Below the name is the slogan 'brake evolution' flanked by two arrowheads pointing outwards.

# summary

pag. 15 Analytical Index for Brake Pads and Brake Shoes

pag. XXX Brake Pads

SERIE3ORGANIC



SERIE4SINTERED



SERIE6OFFROAD



SERIE5RACE



pag. XXX Brake Shoes



pag. XXX Clutches



pag. XXX Cross References



# Key



Manufacturer



C.C.



Model



Year



Front Application



Rear Application



Two discs

# Brake pads and brake shoes

# ANALYTICAL INDEX



## ADLY

	25	Silver Fox	00	05	3076	
	50	Cat	01		3076	
	50	Cosy	01		3076	
	50	Fox	00		3076	
	50	Fox Plus	01		3076	
	50	Jet	96		3076	
	50	Panther	01		3075	
	50	Pista, Pista Twin Light	96		3076	
	50	Silver Fox	00	05	3076	
	50	Silver Fox	06		3075	
	50	Super Sonic	00	05	3075	
	50	Thunderbike	97		3075	
RS	50	Super Sonic	06		3075	3075
RT	50	Road Tracer	02		3076	
	70	Fox Plus	01		3076	
	70	Pista, Pista Twin Light	01		3076	
	80	Cosy	01		3076	
RT	90	Road Tracer	02		3076	
	100	Cat	01		3076	
	100	Jet	96		3076	
	100	Panther	01		3075	
	100	Silver Fox	01	05	3076	
	100	Silver Fox	06		3075	
	100	Super Sonic	01	05	3075	
	100	Thunderbike	01		3075	3075
RT	100	Road Tracer	02		3076	
	125	Cat	01		3076	
	125	Super Sonic	01	05	3075	
	125	Thunderbike	01		3075	3075
	150	ATV	05		3074	3074
	150	Interceptor	05		3074	3074
	300	ATV	05		3074	3074
	300	Cross XOver	07		3133	
	300	Cross XRoad	07		3133	
ATV	300	Sport	07		3133	
	320	S	07		3133	
	320	U	07		3133	

## AEON

	50	Aero	06		3074	
	50	Regal	06		3074	
	50	Torch	06		3074	
	90	Regal	06		3074	
	100	Pulsar	06		3074	
	100	Revo 2	04		3074	
	110	Aero	06		3074	
	110	Pulsar	06		3074	



125	Co-In	14	3074		
125	Elite	13	3070	3074	
125	Overland	02		3064	
125	Oz	14	3021		
125	Pulsar	06	3074		
125	Urban	11	13	3070	3074
125	Urban	14	3021		
150	Pulsar	06	3074		
180	Overland	02		3064	
180	Roadster	02		3064	
250	Elite	11	3070	3074	
350	Urban	11	3070	3074	
400	Elite	13	3070	3074	

**AJP**

PR3	125	Enduro	08	12	3017	3040
PR3	125	Enduro	13		4162	3173
PR3	125	Enduro Pro	13		4162	3173
PR3	125	Extreme	13		4162	3173
PR3	125	Supemotard	08	12	3017	3040
PR3	125	Supemoto	13		4162	
PR3	125	Trial	13	15		3173
PR4	125	Enduro	04		3077	3040
PR4	125	Enduro	13		4162	3173
PR4	125	Enduro Pro	13		4162	3173
PR4	125	Extreme	13	15		3173
PR4	125	Supemotard	04		3077	3040
PR4	125	Supemoto	13		4162	3173
PR4	125	Trail	13		4162	
MX	200		09		3017	3015
PR3	200	Enduro	08	12	3017	3040
PR3	200	Enduro	12	14		3173
PR3	200	Enduro Pro	12	14		3173
PR3	200	200 M/X Pro	12	14		3173
PR3	200	Supemoto	12	14		3173
PR3	200	Supemotard	08	12	3017	3040
PR4	200	Enduro	04		3077	3040
PR4	200	Enduro	12	14		3173
PR4	200	Enduro Pro	13	15		3173
PR4	200	Extreme	12	14		3173
PR4	200	Supemoto	12	14		3173
PR4	200	Supemotard	04		3077	3040
PR4	240	Extreme	10	15		3173
PR3	240	MX	13		4162	3173
PR5	250	Enduro	09		3050	3087
PR5	250	Enduro	10		4162	3173
PR5	250	Extreme	12		4162	3173
PR5	250	Supemotard	09		3050	3087
PR5	250	Supemoto	10		4162	3173
PR7	650	Adventure	17		4162	3087

**ALFER**







MC	80		87		3029	3015
MC	125		87		3029	
MC	125		88		3031	3029
VRE	125	4-stroke	00		3027	3088
GR	250	Enduro	85		3029	



GR	250	Enduro	88	3031	3029
MC	250		85	3029	
MC	250		87	3029	3029
MC	250		88	3031	3029
VR	250	Cross	99	3027	3088
VR	250	Enduro	99	3027	3088
VR	250	No Limit	99	3027	3088
VR	250	Supemotard	99	3027	3088
GR	300		85	3029	
GR	300	Enduro	88	3031	3029

**APRILIA**







	50	Amico, Scooter	92	3010	0304
	50	Amico, GL, GLE	93	3010	
	50	Area 51	99	3010	3010
	50	Business	97	3010	
	50	Classic	96	3010	
	50	Club	97	3010	
	50	Compay	09 13	3010	
	50	Gulliver	96 00	3010	
	50	Habana/Custom	99 02	3010	
	50	McGulliver	00	3010	
	50	Miri RX	04	3042	
	50	Mojito Retro	99 03	3010	
	50	Mojito, Mojito Custom	04 12	3010	
	50	Mojito, Mojito Custom	99 03	3010	
	50	Rally	95	3010	
	50	Red Rose	88 89	3013	
	50	Red Rose	90	3012	
	50	Red Rose Classic	92	3012	
	50	Scarabeo 4T	04	3028	
	50	Scarabeo Ditech	02	3010	3020
	50	Scarabeo Street	00	3010	
	50	Scarabeo, 2nd series	94 99	3010	
	50	Sonic, GP	99	3010	
	50	Sport City One	08	3041	
	50	Tuareg	85	3029	
	50	Tuareg	86	3012	
	50	Tuareg Rally	90	3012	
	50	Tuono	04	3017	3029
	50	Younger	97	3010	
AC	50	Rally	95 02	3010	
AF1	50	AE	86	3012	
AF1	50	Europa, Futura	90	3012	
ET	50		85	3029	
LC	50	Rally	96 01	3010	3010
LX	50	Amico, Sport	92	3011	
MX	50		03	3017	
RS	50	Replica	00 05	3017	
RS	50		93 95	3029	3029
RS	50		96 99	3029	
RS	50		06	3035	3015
RS4	50		12	3142	3074
RS4	50	Replica	16	3142	3074
RX	50	Racing	04 06	3017	
RX	50		90	3017	

								
RX	50				06		3055	3015
SR	50	Ditech			01	06	3010	3020
SR	50	Racing			00		3010	3020
SR	50	Replica (Liquid Cooled)			96		3010	
SR	50	Stealth, Racing			97		3010	3010
SR	50	Street			05	12	3010	3020
SR	50	WWW, Netscaper			97		3067	
SR	50	Europa			93		3011	
SR	50	Replica			94		3025	
SR	50	Urban Kid			93		3011	
SR	50	Viper			93		3011	
SX	50				06	13	3055	
SX	50	Ltd.			14		3063	3074
	100	Scarabeo			00		3028	
	100	Scarabeo 4T			03		3028	
	100	Scarabeo Net			10		3028	
	125	Atlantic			03		3096	3020
	125	Classic			96		3055	3029
	125	Habana/Custom			00	02	3028	0300
	125	Leonardo			96		3010	
	125	Leonardo			97	98	3067	3010
	125	Leonardo			99		3028	3028
	125	Leonardo (Grimeca cal.)			99		3026	3028
	125	Mojito, Mojito Custom			02	12	3028	0300
	125	Pegaso			90	91	3055	
	125	Pegaso			92	99	3017	3095
	125	Red Rose			89		3026	3029
	125	Red Rose			90		3055	3029
	125	Scarabeo, Scarabeo GT			99	03	3026	3020
	125	Scarabeo, Scarabeo GT			04		3096	3020
	125	Sport Pro.			92		3031	3029
	125	Sportcity			04	12	3026	3020
	125	Tuareg				86	3026	
	125	Tuareg			87			3029
	125	Tuareg AS						3029
	125	Tuareg Rally			86		3026	
	125	Tuareg Rally			89		3026	3029
	125	Tuareg Rally			90			3029
	125	Tuareg Rally			92		3055	3095
	125	Tuareg Wind			88		3012	
	125	Tuareg Wind			90		3055	
	125	Tuono			04	07	3031	3029
	125	Tuono ABS			17		3142	3074
AF1	125				87			3029
AF1	125	Europa, Futura			90	92	3031	3029
AF1	125	Replica, Sintesi			89	91	3031	3029
EIX	125				99		3017	
EIX	125					86	3026	
EIX	125	Tuareg			86	87	3026	3029
MX	125				04	07	3027	3095
MX	125	Supermoto			07		3027	3095
MX	125	Cross			85		3026	
RS	125	Extrema			93	98	3031	3029
RS	125				99	05	3031	3029
RS	125				06		3098	3020
RS	125	Pista			05		3031	3029
RS4	125	(AJP cal.)			11		3142	3187





RS4	125	(I.Juan cal.)	11		3030	3074	
RS4	125	Replica, ABS	16		3142	3074	
RX	125		97		3027		
RX	125		90			3095	
RX	125		92		3017	3095	
RX	125	Enduro	08		3027	3074	
RX	125	Supemotard	08		3027	3074	
SR	125		99	03	3028	0300	
SR	125	Max	12		3041	3041	
SR	125	Sport City One	12		3041		
SX	125		08	13	3027	3095	
	150	Leonardo	97	98	3067	3010	
	150	Leonardo	99		3028	3028	
	150	Leonardo (Grimeca cal.)	99		3026	3028	
	150	Scarabeo	99		3026	3020	
	150	Scarabeo, Scarabeo GT	04		3096	3020	
SR	150		00	03	3028	0300	
	200	Atlantic	03		3096	3020	
	200	Scarabeo, Scarabeo GT	02	03	3026	3020	
	200	Sportcity	04	08	3026	3020	
	200	Climber	93		3029	3029	
	200	Scarabeo	07		3096	3020	
	200	Scarabeo Class	10		3096	3020	
	200	Scarabeo ie	12		3096	3020	
	240	Climber	89	90	3012		
TX	240		86		3015		
	250	Leonardo	99		3028	3020	
	250	Leonardo (Grimeca cal.)	99		3026	3020	
	250	Atlantic ie	07		3096	3020	
	250	Scarabeo, Scarabeo ie	06		3096	3020	
	250	Sportcity ie	06	08	3026	3020	•
	250	Tuareg Rally	86		3026	3029	
AF1	250	Replica	90		3031	3141	
MX	250	Cross	85		3029		
RS	250		95	96	3030	3029	
RS	250		97	02	3093	3029	•
RS	250	Pista	04		3093	3029	•
RX	250		86		3029		
	275	Climber	89	90	3012		
	280	R. Climber	92		3015	3015	
	300	Leonardo (Grimeca cal.)	05		3026	3028	
	300	Scarabeo Special	10		3096	3020	
SR	300	Max	12		3041	3041	
TX	311		86		3015		
TX	312	M	88		3015	3015	
TXR	312	M	88		3015	3015	
	350	Tuareg	86		3026	3029	
	350	Tuareg	88	89		3029	
	350	Tuareg Wind	87		3026	3029	
	350	Tuareg Wind	88			3029	
	350	Tuareg Wind	90			3095	
ETX	350			86	3026	3029	
ETX	350		86	92		3029	
	400	Scarabeo ie	07		3026	3020	•
MXV	450		09		3050	3101	
RXV	450		06		3050	3101	
SXV	450		06			3101	

								
SXV	450	Van den Bosch Rep.			08			3101
	500	Atlantic Left/Rear			02	05	3026	3020
	500	Atlantic Right			02	05	3051	
	500	Atlantic Sprint			06		3096	3020
	500	Scarabeo			03	06	3026	3020
	500	Scarabeo Class			10		3026	3020
	500	Scarabeo ie			07		3026	3020
RXV	550				06		3050	3101
SXV	550				06			3101
SXV	550	Van den Bosch Rep.			08			3101
	600	Pegaso			90	92		3095
	600	Tuareg			86		3026	3029
	600	Tuareg Wind			88			3029
ETX	600				86	92	92	3026
	650	Moto			95		3090	
	650	Pegaso			92	94		3095
	650	Pegaso			95	00	3090	
	650	Pegaso Factory			07	09		3088
	650	Pegaso i.e.			01	04	3090	3088
		Tuscany Tibet Raid			04		3090	3088
	650	Pegaso Strada			05	09	3093	3088
	650	Pegaso Trail			06	08	3090	3088
	650	Starck			96		3090	
	750	Dorsoduro Factory			12		3093	3088
SL	750	Shiver, ABS			07		3098	3088
SL	750	Shiver GT, ABS			09		3098	3088
SMV	750	Dorsoduro			08		3093	3088
SMV	750	Dorsoduro			09	16	3098	3088
NA	850	Mana			07		3098	3088
NA	850	Mana GT, ABS			09	13	3098	3026
NA	850	Mana GT, AB (Parking Brake)			09	13		3191
NA	850	Mana, ABS			08	11	3098	3026
SRV	850				12		3027	3041
SRV	850	(Parking Brake)			12			3191
	900	Dorsoduro			17		3098	3088
	900	Shiver			17		3098	3088
	1000	Blue Marlin			02		3093	3035
ETV	1000	Caponord			01	08	3090	3035
ETV	1000	Caponord Rally Raid			04	08	3090	3035
RST	1000	Futura			01	03	3093	3027
RSV	1000	Factory Pista (Rad.cal)			04		3107	3035
RSV	1000	Falco SL, R			00	04	3093	3035
RSV	1000	Mille			97	01	3093	3035
RSV	1000	Mille			02	03	3107	3035
RSV	1000	Mille Nera (Rad.cal)			04		3107	3035
RSV	1000	Mille R			00		3093	3035
RSV	1000	Mille R			01	02	3107	3035
RSV	1000	Mille R			04		3107	3035
RSV	1000	Mille R (Rad.cal)			03		3107	3035
RSV	1000	Mille R (Rad.cal)			05		3107	3035
RSV	1000	Mille R Factory (Rad.cal)			04		3107	3035
RSV	1000	Mille SP			00		3093	3035
RSV	1000	Tuono Fighter			03	05	3093	3035
RSV	1000	Tuono R			03		3107	3035
RSV	1000	Tuono R (Rad.cal), ABS			04		3093	3035
RSV	1000	Tuono R Factory, ABS			06		3107	3035
RSV	1000	Tuono V4 R			11	13	3093	3035



RSV	1000	Tuono V4 R	14	4145	3035	•
RSV4	1000	ABS	09	4113	3035	•
RSV4-R	1000	ABS APRC	10	4113	3035	•
RSV4-RF	1000		15	4113	3035	•
RSV4-RR	1000		15	4113	3035	•
RSV	1100	Tuono V4	15	4145	3035	•
RSV	1100	Tuono V4 Factory	16	4145	3035	•
RSV	1100	Tuono V4 RR	15	4145	3035	•
	1200	Caponord	13	4145	3088	•
	1200	Caponord Rally	15	4145	3088	•
	1200	Dorsoduro, ABS	11	3093	3088	•

**ARCTIC CAT**

	50	DVX	06		3064		
	90	DVX	06		3064		
	250	DVX	06	09	3133	3037	•
	300	DVX	09		3133	3037	•
	400	DVX	04	08	3106	3037	•

**ARMSTRONG**

MX	500		86		3029	
MX	600		86		3029	

**ASPES**

	125	Sintesi	88		3031	3029
--	-----	---------	----	--	------	------

**ATALA**

	25	Carosello	97		3010	
AT10	25		97		3011	
	50	Carosello	97		3010	
	50	Hacker	95		3010	
	50	Skeggia	98		3011	
AT10	50		97		3011	
	125	Hacker	98		3010	

**ATK**

		all models	94		3063	3063
ATK	250	CC,MX	91	92	3031	3029
ATK	350	ES CC,MX,STD	91	92	3031	3029
ATK	350	GS	93		3029	3029
ATK	406	CC,MX	91	92	3031	3029
ATK	560		84	85	3029	
ATK	560		86		3029	
ATK	560		87	88	3029	3015
ATK	560		89	91	3031	3012
ATK	604		91		3031	3012
ATK	604	ES CC,MX,STD	91	92	3031	3029
ATK	604	Quadracer	90		3031	3012
ATK	640		93		3029	3029

**BAOXIN**

BX	125	L	97		3019	
----	-----	---	----	--	------	--

**BARIGO**

		Scooter electric	97		3015	01205
--	--	------------------	----	--	------	-------



**BATAVUS**

	Grand Prix	80	3095
--	------------	----	------

**BENELLI**

	50	Chrono	92	93	3012	
	50	Chrono	94		3010	
	50	Devil	92		3031	3013
	50	Naked	02		3010	01205
	50	Nemo, Quadra	94		3010	
	50	Pepe	99		3010	
	50	Spring	92		3031	3013
491	50	GL Sport	98		3010	
491	50	Naked	99		3010	
491	50	Racing	99		3010	3010
491	50	RR -GP	00		3010	3010
491	50	ST	01		3010	
491	50	Superbike	99		3010	3010
K2	50	Air	98		3010	3010
K2	50	LC	99		3010	3010
K2	50	Namur	99		3010	3010
KB-X	50	Race			3076	
	100	Naked	02		3010	
K2	100	Biposto	99		3010	
LX	100	Pepe	02		3010	01205
	124	T	83		3029	
	125	2CE	76	78	3029	
	125	Adiva	00		3010	3024
	125	Velvet, Velvet Touring	99		3010	3029
	125	Caffenero Left/Rear	08		3063	3063
	125	Caffenero Right	08		3064	
	125	Custom	85		3029	
	125	Iarno	89		3031	3029
	125	MJ	10		3063	3063
	125	Sport			3029	
	125	T	76		3029	
	125	TT			3029	
666	125	Born in Hell	98		3093	3010
BX	125		89		3031	3029
BXK	125		88		3029	3015
E	125	LC	85		3029	
TNT	125		17		3190	
	150	Adiva	00		3010	3024
	150	MJ	10		3063	3063
	150	Velvet, Velvet Touring	00		3010	3029
	250	2CE			3029	
	250	Velvet, Velvet Touring	99		3010	3029
	250	Caffenero Left/Rear	08		3063	3108
	250	Caffenero Right	08		3064	
	250	Disc	76		3029	
BN	302		14		3093	3035
BN	302		15			3082
BN	302	Tomado	16			3082
	304		83		3029	
	350	4T Turismo			3029	3141
	350	Zenzero	12		3070	3074
	354		78	82	3029	3141
	354	Sport	83		3029	3029



	400	Velvet Dusk	03		3017	3010	
BX	449	Cross	07		3027	3088	
BX	449	Supermotard	08		3107	3088	
	500	4	76		3029		•
	500	4T		76	3029	3141	
	500	Leoncino	16		3093	3035	•
TRK	502		16		3093	3035	•
BX	505	Enduro	08		3027	3088	
BN	600		12	13	3093	3035	•
BN	600		14		3107	3035	•
BN	600	GT	14		3107	3035	•
	654	Sport	83		3029	3029	•
	750	Sei	75		3141		•
	756	Cue	07	09	3107	3035	•
	756	Cue	10		3093	3035	•
	899	Trek	07		3093	3035	•
TnT	899		07		3093	3035	•
TnT	899	Century Racer	11		3107	3035	•
	900	Tornado TRE	03	06	3107	3035	•
	900	Tornado TRE RS (Rad.cal)	04	06	3107	3035	•
	900	Sei	84		3141	3141	•
	900	Tornado 3	00	06	3093	3029	•
TnT	1100		04		3093	3029	•
TnT	1130		05		3093	3035	•
TnT	1130	Cafe Racer	05		3107	3035	•
TnT	1130	Officine	07		3107	3035	•
TnT	1130	Sport	05		3107	3035	•
TnT	1130	Titanium	05		3107	3035	•
TnT	1130	Trek	06		3093	3035	•
TnT	1130	Trek Amazonas	07		3093	3035	•
TnT	1130	Century Racer	11		3107	3035	•
TnT	1130	R	17		4113	3035	•

**BETA**

		AIP Caliper incl. pin/spring			3015		
ALP			90		3013	3012	
SR		34	89		3015		
	50	Ark AirCooled	99		3010		
	50	Ark K Series	97		3010	3010	
	50	Ark LC	99		3010	3010	
	50	Crono 502	97		3029		
	50	Fikon	99		3015	3015	
	50	Quadra	95	96	3010		
	50	Quadra	97	00	3029		
	50	Tempo	97	98	3029		
	50	Chrono 13	94	99	3010		
	50	Fikon	04		3010	3020	
	50	ProRace 12/10	04		3042	3042	
	50	Rev	00		3015	3015	
	50	Super Trial	92		3015		
	50	Techno	96		3015	3015	
	50	Tempo	92	96	3015		
	50	Tempo	99		3010		
	50	Tempo (13" wheels)	00		3010		
	50	Tempo (16" wheels)	00		3010		
AE	50	Four Twin	88		3013		
ALP	50		91		3013	3012	



KR	50		86	87	3029	
KR	50	Twin	88		3029	3029
MX	50	Enduro	92		3012	
RR	50	Enduro	99		3055	3015
RR	50	Enduro	10		3017	3125
RR	50	Enduro Alu	04	07	3017	
RR	50	Pro Race	98		3055	3015
RR	50	Standard	99		3055	3015
RR	50	Supemotard	99	03	3055	3015
RR	50	Supemotard	04	07	3015	3015
RR	50	Supemotard	08		3017	3125
RR	50	Supemotard Alu	04	05	3017	
RV	50		88		3013	
ST	50		97		3015	3015
VRS	50		86		3013	
	80	EVO	09		3040	
	80	EVO Junior	10		3015	3015
	80	Rev	00	07	3015	3015
	80	Rev	08		3040	
	125	Eikon	99	03	3015	3015
	125	M4	06		3017	3125
	125	Eikon	04		3010	3020
	125	EVO	09		3040	
	125	Jonathan	99		3030	3088
	125	Rev 3	00	05	3040	3040
	125	Rev 3	06		3040	
	125	Urban	10		3017	3125
ALP	125		99		3015	3015
ALP	125	4-stroke	00	05	3015	3015
ALP	125	4-stroke	06		3017	3125
RR	125	Enduro 4T	10		3017	3125
RR	125	Supemotard	08		3017	3125
TR	125	32,33	86	87	3013	
TR	125	34	88		3013	3012
TR	125	34,35	89	90	3015	3015
TRIAL	125		97		3015	
	150	Eikon	99	03	3015	3015
	150	Eikon	04		3010	3020
R	150		10		3069	
	200	EVO	09		3040	
	200	Rev 3	06		3040	
	200	Urban	10		3017	3125
ALP	200	4-stroke	00	05	3015	3015
ALP	200	4-stroke	06		3017	3125
	240	Super Trial	92		3015	
ALP	240		92		3015	
ALP	240		96		3015	3029
TR	240	33	86	88	3013	
	250	4-T Rev 3	07		3040	
	250	Eikon	99		3015	3015
	250	EVO (2-T / 4-T)	09		3040	
	250	Rev 3	00	04	3040	3040
	250	Rev 3	05		3040	
	250	Techno	96		3015	3015
	250	Zero	91		3015	
ALP	250		92		3015	
ALP	250		97		3015	3015



CR	250		83		3029	
RR	250		05		3050	3101
	260	Synt	92		3013	
	260	Zero	91		3015	
ALP	260		96		3015	3029
TR	260	34	86	88	3013	3012
TR	260	34,35,ZERO	89	92	3015	
	270	Rev 3	00	04	3040	3040
	270	Rev 3	05		3040	
	290	EVO	09		3040	
	300	Crosstrainer	15		3050	3101
	300	EVO	09		3040	
RR	300		13		3050	3101
	350	M4 (Brembo cal.)	06		3030	3125
	350	4.0 Motard	04		3030	
	350	Euro	99		3030	3088
	350	Jonathan	02		3030	3088
ALP	350	4,0	04	05	3017	
ALP	350	4,0	06		3017	3125
RR	350	Efi	15		3050	3101
RR	350	Efi Racing	15		3050	3101
RR	350	Enduro	12	14	3050	3101
RR	390		15		3050	3101
RR	400	Enduro	05		3050	3101
RR	430		15		3050	3101
RR	430	Racing	15		3050	3101
RR	450	Enduro	05		3050	3101
RR	450	Cross Country	12		3050	3101
RR	480		15		3050	3101
RR	480	Racing	15		3050	3101
RR	498	Enduro	12		3050	3101
	500	CS, RV	84		3029	
RR	525	Enduro	05		3050	3101

**BIMOTA**

		all models	82	88	3141	3141	•
		Furano	92		3030	3029	•
1D		Tesi	93		3030	3029	•
SB3		D	83		3141	3141	•
BBX	300	Enduro	12		3050	3101	
YB7	400		89		3030	3029	•
	500	Vdue	97	00	3030	3029	•
BBX	508	Enduro	12		3050	3087	
	600	Bellaria	91		3030	3029	•
YB9	600	SRI	97		3030	3029	•
BB1	650	Supermono	97	00	3030	3029	•
SB7	750		96		3030	3029	•
YB4	750		89		3030	3029	•
3D	800	Tesi	16		4113	3035	•
1D	851	Tesi	91		3030	3029	•
DB2	900		92	00	3030	3029	•
DB3	900	Mantra	97	00	3030	3029	•
DB4	900		99	00	3093	3029	•
1D	906	Tesi	91		3030	3029	•
2D	1000	Tesi	04	06	3030	3029	•
BB3	1000		14		4113	3035	•
DB5	1000	Mille (Rad.cal)	05	11	3107	3035	•



DB5	1000	S (Rad.cal)	07	11	3107	3035	•
DB6	1000	Delirio (Rad.cal)	07		3107	3035	•
SB8	1000	R	98	00	3093	3029	•
SB8K	1000		06		3093	3029	•
SB8K	1000	Santamonica	07		3107	3029	•
YB11	1000		97		3030	3029	•
YB6	1000		89		3030	3029	•
YB8	1000		90		3030	3029	•
	1002	Dieci	91		3030	3029	•
DB10	1078	Bimotard	12		3107	3035	•
DB5	1078	RE	12		3107	3035	•
DB7	1098	(Rad.cal)	08		3107	3035	•
DB7	1099	(Rad.cal)	09		4113	3029	•
3D	1100	Tesi (Rad.cal)	07		3107	3035	•
DB6R	1100	Delirio (Rad.cal)	08		3107	3035	•
DBX	1100		13		3090	3027	•
SB6	1100		97	00	3030	3029	•
DB8	1198	(Rad.cal)	10		4113	3035	•
	1200	Impeto	16		4113	3035	•
DB11	1200	VLX (Rad.cal)	13		4113	3035	•
DB12	1200		12		3107	3035	•
DB9	1200	Brivido	12		3107	3035	•







**BLATA**

	125	Enduro	07		3142	3015	
	125	Motard	07		3142	3015	

**BMW**

C		Evolution	12		3059	3059	•
C		Evolution (Parking Brake)	12			3191	
	125	C1	00		3090	3088	
	200	C1	02		3090	3088	
G	310	GS	17		3154	3088	
G	310	R	16		3154	3088	
G	450	SMR	09	10	3107	3056	
G	450	X	08	10	3027	3056	
C	600	Sport	12	15	3059	3059	•
C	600	Sport (Parking Brake)	12	15		3191	
C	650	GT	12	15	3059	3059	•
C	650	GT (Parking Brake)	12	15		3191	
C	650	GT	16		3059	3059	•
C	650	Sport	16		3059	3059	•
F	650	ST	94	00	3090	3088	
F	650	CS Scarver	02	06	3090	3088	
F	650	GS	08	12	3090	3088	
F	650	GS ABS	01	07	3090	3088	
F	650	GS ABS	08	12	3090	3088	
F	650	GS Dakar	01	07	3090	3088	
F	650	GS Rallye	01	07	3090	3088	
F	650	ST Strada	97	01	3090	3088	
G	650	GS	09		3090	3088	
G	650	GS Sertao	12	14	3090	3088	
G	650	Xchallenge	06	07	3090	3088	
G	650	Xcountry	06	09	3090	3088	
G	650	Xmoto	06	07	3093	3088	
R65	650	GS	87	92	3141		
R65	650	GS	91	92	3141		



									
R65	650	LS			82	85	3141	•	
R65/1	650				86		3141	•	
F	700	GS			13		3090	3088	•
R70	700	Series			74	80			
K75	750				90		3141	3141	
K75	750	C			85	88	3141		•
K75	750	RT			91		3141	3141	•
K75	750	S,C			85	95	3141	3141	•
F	800	GS			08		3090	3088	•
F	800	GT			13		3093	3088	•
F	800	R			09	14	3093	3088	•
F	800	R			15		4145	3088	•
F	800	S			6	10	3093	3088	•
F	800	ST			6	12	3093	3088	•
F	800	ST Touring			11	12	3093	3088	•
R80	800				85		3141		
R80	800	G/S P.-D.			86		3141		
R80	800	GS			81	87	3141		
R80	800	R			91			3141	•
R80	800	R			93		3141		
R80	800	RT			83		3141		•
R80/7	800				79	81		3141	
R	850	C			99	01		3084	•
R	850	GS			99	07		3084	•
R	850	R			96			3084	•
R	850	R			3	07	4124	3084	•
R	850	RT			96	01		3088	•
R	850	RT With Integral ABS			1	06	4123	3084	•
K1	1000				89			3141	•
K100	1000	LT			87		3141	3141	•
K100	1000	LT			92			3141	•
K100	1000	LT ABS			89		3141	3141	•
K100	1000	RS			90			3141	•
K100	1000	RS ABS			88	89	3141	3141	•
K100	1000	RS, RT			83	89	3141	3141	•
R100	1000				81	84	3141	3141	•
R100	1000	CS, RS, RT			81	84	3141	3141	•
R100	1000	R			91			3141	•
R100	1000	RS			76	80		3141	•
R100	1000	RS			93		3141	3141	•
R100	1000	S			78	80		3141	•
R100	1000	T			79			3141	•
S	1000	R			13		4122	3088	•
S	1000	RR			09		4122	3088	•
S	1000	RRHP4			12	14	4113	3088	•
S	1000	XR			15		4145	3084	•
K1100	1100	LT/SE			92			3141	•
K1100	1100	RS			93			3141	•
R	1100	GS			99			3084	•
R	1100	R			99			3084	•
R	1100	RT			95			3084	•
R	1100	S			99	00		3084	•
R	1100	S With Integral ABS			01	05	4124	3084	•
R	1100	S Without Integral ABS			01	05	4123	3084	•
R1100	1100	GS			94			3084	•
R1100	1100	RS			93			3141	•
R1100	1100	RS			94			3141	•



R	1150	GS	00	01		3084	•
R	1150	GS,GS Adventurer	02	05	4123	3084	•
R	1150	R	01	06	4124	3084	•
R	1150	R Rockster	03	05	4124	3084	•
R	1150	RS	01	04	4124	3084	•
R	1150	RT With Integral ABS	01	06	4123	3084	•
	1200	HP2 Enduro	04	06	3090	3027	•
	1200	HP2 Megamoto	06	08	4123	3084	•
	1200	HP2 Sport	08	10	4113	3027	•
K	1200	GT (K41) With Integral ABS	02	05	4123	3141	•
K	1200	GT (K44) With Integral ABS	04		4123	3027	•
K	1200	LT With Integral ABS	01	08	4124		•
K	1200	R	05	08	4124	3084	•
K	1200	R Sport	05	07	4124	3084	•
K	1200	RS	97	00		3141	•
K	1200	RS	01	05	4123	3141	•
K	1200	S	05	08	4123	3084	•
R	1200	C	98	02		3084	•
R	1200	C Classic	03	04	4124	3084	•
R	1200	C Independent	03	04	4124	3084	•
R	1200	C Montauk	02	04	4124	3084	•
R	1200	CL	03	04	4124		•
R	1200	GS	04	12	4123	3084	•
R	1200	GS	13		4145	3090	•
R	1200	GS Adventure	14		4145	3090	•
R	1200	GS Triple Black	11		4123	3084	•
R	1200	Nine-T	14		4145	3027	•
R	1200	Nine-T Pure	17		3093	3027	•
R	1200	Nine-T Racer	17		3093	3027	•
R	1200	Nine-T Scrambler	16		3093	3027	•
R	1200	Nine-T Urban GS	17		3093	3027	•
R	1200	R	07	14	4124	3084	•
R	1200	R	15		4145	3090	•
R	1200	RS	15		4145	3090	•
R	1200	RT	06	13	4123	3084	•
R	1200	RT	14		4145	3090	•
R	1200	S	06	07	4123	3084	•
R	1200	ST	06	07	4123	3084	•
K	1300	GT	09	10	4123	3027	•
K	1300	R	09		4124	3084	•
K	1300	R Dynamic	11		4124	3084	•
K	1300	S	09		4123	3084	•
K	1600	B	17		4124	3090	•
K	1600	GT	11		4124	3090	•
K	1600	GTL	11		4124	3090	•

**BOMBARDIER**

	200	Rally 2x4	03	04	3074		•
	200	Rally 2x4	05	06	3074	3095	•
DS	250	Left/Rear	06		3108	3108	
DS	250	Right	06		3110		
	330	Outlander Left/Rear	03	06	3108	3108	
	330	Outlander Right	03	06	3110		
	400	Outlander Left/Rear	03	06	3108	3108	
	400	Outlander Right	03	06	3110		
	400	Outlander Max Left/Rear	03	06	3108	3108	
	400	Outlander Max Right	03	06	3110		



	500	Quest Left/Rear	02	06	3108	3108	
	500	Quest Right	02	06	3110		
	500	Traxter 4x4	99	00	3035	3035	•
	500	Traxter 4x4 Left/Rear	01	06	3108	3110	
	500	Traxter 4x4 Right	01	06	3110		
	500	Traxter Max Left/Rear	03	05	3108	3110	
	500	Traxter Max Right	03	05	3110		
	650	Quest Left/Rear	02	06	3108	3108	
	650	Quest Right	02	06	3110		
	650	Quest Max Left/Rear	03	06	3108	3110	
	650	Quest Max Right	03	06	3110		
	650	Traxter Max Left/Rear	03	05	3108	3110	
	650	Traxter Max Right	03	05	3110		
DS	650	Left/Rear	01	06	3108	3108	
DS	650	Right	01	06	3110		
	800	Outlander Left/Rear	06		3108	3108	
	800	Outlander Right	06		3110		
	800	Outlander XT Left/Rear	06		3108	3108	
	800	Outlander XT Right	06		3110		

**BORILE**

B	500	CR, MT	02		3030	3088	
---	-----	--------	----	--	------	------	--

**BRAMMO**

		Empulse	14	16	3093	3035	•
--	--	---------	----	----	------	------	---

**BS VILLA**

AX	50		93		3076		
GZ	50		93		3076		
ZX	50		93		3132		

**BUELL**







	500	Blast	01	09	3059	3073	
XB9R	984	Firebolt	02	10		3073	
XB9S	984	Lightning	03	10		3073	
XB9SX	984	CityX	05	10		3073	
M2	1200	Cyclone	98	02		3073	
S1	1200	Lightning	98	02		3073	
S1	1200	Whitelighting	98	02		3073	
S3	1200	Thunderbolt	98	02		3073	
X1	1200	Lightning	01	02		3073	
XB12R	1200	Firebolt	04	08		3073	
XB12R	1200	Firebolt	09	10		3073	
XB12S	1200	Lightning	04	08		3073	
XB12Scg	1200	Lightning	06	08		3073	
XB12Scg	1200	Lightning	09	10		3073	
XB12Ss	1200	Lightning Long	06	08		3073	
XB12Ss	1200	Lightning Long	09	10		3073	
XB12STT	1200	Super TT	07	10		3073	
XB12X	1200	Ulysses	06	10		3073	

**BULTACO**

	50	Astro	01		3055	3015	
	50	Lobito	99		3055	3015	

**CAGIVA**

		AIP Caliper incl. pin/spring			3015		
--	--	------------------------------	--	--	------	--	--

							
	50	City		95		3099	
	50	Lucky Explorer		88		3029	
	50	Blues		89		3026	
	50	City		92	94	3132	
	50	City		08		3076	
	50	Cocis		88		3029	
	50	Cocis		89		3029	3029
	50	Corsa		98		3015	
	50	Cucciolo		97		3029	
	50	Mantis		99		3015	
	50	Mito		99		3069	3015
	50	Nuvola		00		3029	
	50	Prima		92		3029	3029
	50	Prima		93			3025
	50	Progress		98		3015	
	50	Super City		93			3029
	50	Supercity		92		3029	3029
	50	W4		92		3029	3029
WMX	50			89			3095
	80	City		93			3025
	80	Cocis		91		3029	
	80	Prima		92			3025
	80	Super City		94			3029
	80	Supercity		92	93	3029	3029
	80	W4		92		3029	3029
LR	80			83		3029	
SST	80			83		3029	
SXT	80			83		3029	
	110	Passing		94		3063	
	125	Dakar		86		3029	
	125	Elefantre		87		3029	
	125	Enduro		86		3029	
	125	Planet		97	07	3030	3029
	125	Aletta Electra		87		3029	
	125	Aletta Oro		86		3029	3029
	125	Blues				3026	3029
	125	Blues		93		3029	3029
	125	Cruiser		88			3029
	125	Cucciolo		00		3029	
	125	Freccia		89			3029
	125	Freccia C 12 R		91			3029
	125	Mito		91	92		3029
	125	Mito		93		3030	3029
	125	Nuvola		00		3029	
	125	Raptor		03	10	3030	3029
	125	Roadster		94		3026	
	125	Stella		97		3069	
	125	Supercity		92	00		3029
	125	Tamanaco					
	125	Tamanaco		89			3029
	125	W8		92	95	3029	3029
K7	125			91			3029
N1	125			96			3029
WMX	125	GP-Replica		86		3029	
WRX	125					3029	
	200	Elefant		86		3029	
	200	Roadster		96		3026	



MXR	250		82		3029	
SST	250	Ala Verde	81		3029	
WMX	250	GP	82		3029	
	350	Alazurra	85	86	3029	3029
	350	Alazurra	87		3029	3029
	350	Elefant	86			3029
	350	W 12	92			3029
SST	350		83		3029	
SST	350	Ala Verde	81		3029	
SXT	350	Ala Rosa	82		3029	
T4	350	E	87		3029	
T4	350	R	87		3029	
MXR	400		82		3029	
	500	Canyon	99		3143	3064
	500	Mito	07		3030	3029
	500	River	00		3030	3029
MXR	500		82		3029	
T4	500	E	87		3029	
WMX	500		85	86	3029	
WMX	500	Cross	87		3029	3029
SP	525	Mito	08	10	3030	3029
	600	Canyon	95		3063	3064
	600	River	94	99	3030	3029
	650	Alazurra			3029	3029
	650	Elefant	86			3029
	650	Raptor	01		3093	3035
	650	V-Raptor	01		3093	3035
	750	Elefant	88		3029	3029
	750	Elefant	93	95	3143	3027
	750	Lucky Explorer	88			3029
	900	Canyon I.E.	97		3143	3064
	900	Elefant	93	97	3027	3027
	900	Elefant I.E.	91	92	3143	3064
	900	Gran Canyon	99	04	3059	3064
	1000	Navigator, T	00	05	3059	3064
	1000	Raptor	00		3093	3035
	1000	V-Raptor	00		3093	3035
	1000	X3 Raptor	04		3107	3035
	1000	X-Raptor	03		3107	3035
	1000	Xtra Raptor	02		3093	3035

**CAN-AM**

DS	90	X	08		3074	3074
	200	ASE	86		3029	
	250	ASE	86		3029	
	250	MX LC	86		3029	
DS	250		08		3133	3133
	350	ASE	86		3029	
	400	Outlander EFi Left/Rear	09		3108	3110
	400	Outlander EFi Right	09		3110	
	400	Outlander MAX STD Left/Rear	07		3108	3110
	400	Outlander MAX STD Right	07		3110	
	400	Outlander MAX XT Left/Rear	07		3108	3110
	400	Outlander MAX XT Right	07		3110	
	400	Outlander STD Left/Rear	07		3108	3110
	400	Outlander STD Right	07		3110	
	400	Outlander XT Left/Rear	07		3108	3110



400	Outlander XT Right	07		3110	
406	ASE	87		3029	
500	ASE	86		3029	
500	MX	86		3029	
500	Outlander MAX STD Left/Rear	07	12	3108	3110
500	Outlander MAX STD Right	07	12	3110	
500	Outlander MAX XT Left/Rear	07	12	3108	3110
500	Outlander MAX XT Right	07	12	3110	
500	Outlander STD Left/Rear	07	12	3108	3110
500	Outlander STD Right	07	12	3110	
500	Outlander XT Left/Rear	07	12	3108	3110
500	Outlander XT Right	07	12	3110	
500	Renegade Left/Rear	08	11	3108	3110
500	Renegade Right	08	11	3110	
560	Sonic	86		3029	
650	Outlander MAX STD Left/Rear	07	12	3108	3110
650	Outlander MAX STD Right	07	12	3110	
650	Outlander MAX XT Left/Rear	07	12	3108	3110
650	Outlander MAX XT Right	07	12	3110	
650	Outlander STD Left/Rear	07	12	3108	3110
650	Outlander STD Right	07	12	3110	
650	Outlander XT Left/Rear	07	12	3108	3110
650	Outlander XT Right	07	12	3110	
800	Commander Left/Rear	11		3064	3063
800	Commander Right	11		3063	
800	Outlander MAX LTD Left/Rear	07	11	3108	3110
800	Outlander MAX LTD Right	07	11	3110	
800	Outlander MAX STD Left/Rear	07	11	3108	3110
800	Outlander MAX STD Right	07	11	3110	
800	Outlander MAX XT Left/Rear	07	11	3108	3110
800	Outlander MAX XT Right	07	11	3110	
800	Outlander STD Left/Rear	07	11	3108	3110
800	Outlander STD Right	07	11	3110	
800	Outlander XT Left/Rear	07	11	3108	3110
800	Outlander XT Right	07	11	3110	
800	Renegade EFi Left/Rear	07	11	3108	3110
800	Renegade EFi Right	07	11	3110	
800	Renegade Left/Rear	08	11	3108	3110
800	Renegade Right	08	11	3110	
800	Renegade X Left/Rear	08	11	3108	3110
800	Renegade X Right	08	11	3110	
1000	Commander Left/Rear	11		3064	3063
1000	Commander Right	11		3063	
1000	Commander MAX Left	14		3064	3108
1000	Commander MAX Right	14		3063	3110
1000	Maverick Left	13		3064	3108
1000	Maverick Right	13		3063	3110

**CANNONDALE**

MX	400	00	03	3050	3086
	440	Blaze Left/Rear	03	3108	3108
	440	Blaze Right	03	3110	
	440	Cannibal Left/Rear	03	3108	3108
	440	Cannibal Right	03	3110	
	440	Glamis Left/Rear	03	3108	3108
	440	Glamis Right	03	3110	
	440	Moto Left/Rear	03	3108	3108



	440	Moto Right		03	3110	
	440	Speed Left/Rear		03	3108	3108
	440	Speed Right		03	3110	
C	440	R		03	3050	3086
E	440	A, R		03	3050	3086
S	440			03	3030	3086
X	440			03	3050	3086

**CCM**

	450	MX		08 10	3027	3101
GP	450			16	3027	3088
604	600	RS		01	3027	3088
604E	600	Sport		99 01	3027	3088
604E	600	Supermoto		99 01	3027	3088
C25	600			96 98	3027	3088
	644	DS		02 06	3027	3088
	644	R30		02 06	3027	3088

**CECTEK**

	500	EFI Gladiator		09	3133	3074	•
	500	EFI King Cobra		09		3074	•
	500	EFI Quadrif		09		3074	•
	500	i Estoc		10		3074	•

**CF MOTO**

	125	Papio		17	3021		
	400	NKEfi		17	3090	3088	•
	550	U-Force Left		15	3064		
	550	U-Force Right		15	3063		
	550	Z-Force Left		15	3064		
	550	Z-Force Right		15	3063		
	650	NK		14 16	3090	3088	•
	650	NKEfi		17	3090	3088	•
	650	TK		14	3090	3088	•
	800	Z-Force EX Left		15	3064		
	800	Z-Force EX Right		15	3063		

**COBRA**

CX	50	Big Wheel		10	3032	3032
CX	50	Junior		07 10	3032	
CX	50	Junior		11	3032	3032
CX	50	Senior		07	3032	3032

**CPI**

	50	Baby		02	3074	01205
	50	GTR		02	3017	
	50	GTR		03	3035	3010
	50	GTS		02	3017	3016
	50	Hussar		01 02	3074	01205
	50	Hussar		03 06		01205
	50	Mars		01		01205
	50	Oliver		03		01205
	50	Oliver City		03 12		01205
	50	Oliver Sport		03 12		01205
	50	Popcom		01 02		01205
	50	Supermoto, Supercross		03	3015	3015
	125	GTR, GTS		02	3017	3010



	125	Sahel	02	3050	3087	
	125	Supemoto	07	3015		
	125	X-Large	02	3035	3035	•
	200	GTR, GTS	02	3017	3010	
	200	X-Large	02	3035	3035	•
	250	XS ATV	07	3133		•
XS	250	Quad	06	3074		•

**CZ**

CZ	180		93	3141		
----	-----	--	----	------	--	--

**DAELIM**

	50	a Four	06	3070			
	50	Besbi	07	3087			
	50	Bonita	09	3132			
	50	Delfino	99	3083			
	50	E-Five	03	3083			
	50	History, S-Five	01	3083	3083		
	50	Message II	02	3083			
	50	Tapo	99	3083			
	50	Vivo	99	3083			
GZ	50	G Message	98	3132			
SE	50	Cordi	06	3083			
SI	50	S-Five	06	12	3132		
	100	Altino	99	3083			
	100	Delfino	99	3083			
	110	City Ace	03	3069			
	125	Altino	02	3083			
	125	Delfino	08	3070			
	125	DLX, Otello DLX	01	3083	3083		
	125	History	01	3083	3083		
	125	Message II	00	3083			
	125	Otello	99	3083			
	125	Otello	08	3018	3083		
	125	Roadwin	04	3071	3021		
	125	Rocket	99	3071			
	125	S2	06	3059	3083		
	125	S2 FI	07	3018	3083		
NF	125		03	3083			
NS	125	II	00	3083			
SC	125	Besbi	08	3087			
SL	125	U3 FI	07	3018	3083		
SV	125	S3	11	3018	3021		
VL	125	Daystar	00	3071			
VS	125	Evolution	95	3083			
VT	125	Evolution	00	3071			
VT	125	Magna	97	3071			
	250	Roadwin	08	3071	3021		
	250	S2	06	3059	3083		
ST	250	Sector Quad	05	06	3074	3100	•

**DB MOTORS**

ZZ	50	Pirat	00	3029	3029	
ZZ	50	Sport	00	3029		

**DERBI**

		AIP Caliper incl. pin/spring		3015		
--	--	------------------------------	--	------	--	--





FD		Yumbo	84		3015	
FD		Yumbo Extra	87		3015	
FDS			87		3015	
FDT			87		3015	
FDT		Coppa	85		3015	
	50	Atlantis	99		3015	
	50	Atlantis 4T	04		3015	
	50	Atlantis Bullet	04		3015	
	50	Atlantis H2O	01		3015	
	50	Atlantis H2O Wave	01		3015	
	50	Atlantis Wave	01		3015	
	50	Aventura	96		3015	
	50	Black Devil	04		3017	3015
	50	Boulevard	09		3041	
	50	DRD Pro corse	06		3142	3015
	50	DRD Racing R	05		3017	3015
	50	DRD Racing R Ltd.	05		3017	3015
	50	DRD Racing SM	05		3017	3015
	50	DRD Racing SM Ltd.	05		3017	3015
	50	Easy	96		3029	
	50	Fenix	94		3015	3015
	50	Furax	96		3015	3015
	50	Hunter	97		3015	
	50	Manhattan	99		3015	
	50	Predator LC	99		3015	3015
	50	Predator O2	00		3015	3015
	50	Rambla	06		3015	3015
	50	Savannah	91		3015	
	50	Senda DRD Pro SM	05		3035	3048
	50	Senda L	99		3015	3015
	50	Senda R DRD	03	04	3055	3015
	50	Senda R, X-Treme	94	04	3015	3015
	50	Senda SM DRD	03	04	3015	3015
		Black Edition	03		3017	3015
	50	Senda SM, X-Treme	99		3015	3015
	50	Sonar	10		3014	
	50	Stinger	96		3015	
	50	Vamos FL	95		3015	
	50	Vamos L	95		3015	
	50	Vamos R (A.I.P. cal.)	95		3015	
	50	Vamos R (Brembo cal.)	95		3010	
	50	Variant Sport-R	01		3015	
	50	X-Race R	05		3015	3015
	50	X-Treme R	05		3015	3015
DS	50		88		3015	
FDX	50		89		3015	
GP	50		01		3015	
GP1	50		01		3015	3015
GP1	50		05		3035	3015
GPR	50	Nude	04		3035	3015
GPR	50	R	98		3055	3015
GPR	50	Racing	04		3035	3015
GPX1	50		06		3142	3015
ST	50	Paddock	96		3015	
	75	GPR	89		3012	3015
	75	Sport, Coppa	84	-	3015	
GPR	75	Sport			3012	3015



GPR	80	Cup	04	3142	3015	
	100	Atlantis 4T	04	3015		
	100	Atlantis O2/H2O	01	3015		
	125	Atmosphere	99	3055		
	125	Boulevard	03	3048	0300	
	125	Mulhacen	07	3017	3029	
	125	Mulhacen	08	4162	3187	
	125	Predator	99	3015		
	125	Rambla	08	3026	3020	
	125	Senda Baja	06	3017	3048	
	125	Senda DRD SM	10	3035	3187	
	125	Senda R 4T	04	3017	3015	
	125	Senda X-Treme SM 4T	04	3017	3015	
	125	Terra	07	3015	3029	
	125	Terra	08	4162	3187	
	125	Terra Adventure	08	4162	3187	
GPI	125		05	3035	3015	
GPR	125		05	3142	3015	
GPR	125	Nude	05	3142	3015	
GPR	125	Racing	09	3142	3015	
	150	Boulevard	03	3048	0300	
	180	Predator	99	3055		
DXR	200	Quad (Front disc)	04	3074	3095	•
DXR	200	Quad (Front drum)	04	01205	3095	
DXR	200	Quad (Front drum)	04	01205	3063	
	250	RC	85	3029		
DXR	250	Quad (Front disc)	04	3074	3095	•
DXR	250	Quad (Front drum)	04		3095	
DXR	250	Quad (Front drum)	04		3063	
GPI	250		05	3035	3024	
	300	Rambla	08	3026	3020	
	659	Mulhacen	05	4119	3035	
	659	Mulhacen	06 07	3107	3035	
	659	Mulhacen Cafe	08	3107	3035	







**DUCATI**

	250	Desmo	77	3141		
	350		75	3029		
	350	Desmo	77	3141		
	350	F3	86	3141	3141	•
	350	F3	86	3029	3029	•
	350	GTV	77	3029	3029	
	350	Indiana	86		3029	
	350	Paso	86	3029	3029	•
	350	Sport	77	3029	3029	•
	400	Monster (Japan)	01 06	3093	3029	
	400	Scrambler Sixty Two	16	3090	3088	
	400	SS, Junior	92 97	3030	3029	•
	400	SS, Nuda	92	3030	3029	
	500	GTV	77	3029	3029	•
	500	Pantah	85	3029	3029	•
	500	Sport	77	3141	3141	•
	500	Sport Desmo	77	3029		•
	500	Twin GIL	75	3029		
	502	Single	93	3030	3029	•
	502	Supermono	93	3030	3029	•
	600	Monster	00 01	3093	3029	

	600	Pantah TL, SL				3141	3141		•
	600	SL, TL Pantah	76			3141	3029		•
	600	SS Supersport	95	00		3030	3029		
M	600	Monster	94	99		3030	3029		
	620	Monster Dark i.e.	02	06		3093	3029		
	620	Monster i.e., s i.e.	02	06		3093	3029		•
	620	Multistrada	05	06		3027	3035		•
	620	Multistrada Dark	05	06		3093	3035		
	620	Sport	03	06		3093	3035		•
	650	Indiana	86				3029		
	650	Pantah	84			3141	3141		•
	695	Monster	07	12		3027	3029		•
	696	Monster (Rad.cal)	08	12		3093	3035		•
	748	S	99	02		3093	3029		•
	748	Biposto	95	98		3030	3029		•
	748	R	00			3093	3029		•
	748	R	01	02		3107	3029		•
	748	SP	95	97		3030	3029		•
	748	SPS	98	99		3093	3029		•
	749	S	03	07		3107	3035		•
	749	R (Rad.cal)	04	07		3107	3035		•
	750	F1	86			3141	3141		•
	750	GT	74	76		3141			•
	750	Indiana					3029		
	750	Monster	96	99		3030	3029		•
	750	Monster	00	01		3093	3029		•
	750	Monster i.e.	02			3093	3029		•
	750	Paso	86			3029	3029		•
	750	Paso	87			3141	3029		•
	750	Paso	88			3029	3029		•
	750	Sport	90			3141	3141		•
	750	Sport	00	02		3093	3035		
	750	SS	74			3141	3141		•
	750	SS	91			3030	3141		
	750	SS Supersport	95	99		3030	3029		
	750	SS, Carenara	92			3030	3029		
	750	SS, Nuda	92			3030	3029		
	750	Super Sport	92	94		3030	3029		•
	750	Super Sport	00	02		3093	3035		•
	795	Monster	12			3093	3035		•
	796	Hypermotard ABS	10	12		3093	3035		•
	796	Monster (Rad.cal)	11	14		3093	3035		•
	796	Monster ABS (Rad.cal)	11	14		3093	3035		•
	797	Monster	17			4145	3088		
	800	Hypermotard	13	15		4145	3035		•
	800	Hypermotard ABS	13	15		4145	3035		•
	800	Hypermotard SP	13	15		4145	3035		•
	800	Hypermotard SP ABS	13	15		4145	3035		•
	800	Hyperstrada	13	15		4145	3035		•
	800	Hyperstrada ABS	13	15		4145	3035		•
	800	Monster Dark i.e., s i.e.	03	07		3093	3029		•
	800	Monster i.e., s i.e.	03	07		3093	3029		•
	800	Monster S2R	05	07		3027	3029		•
	800	Monster S2R ABS	05	07		3027	3029		•
	800	Scrambler Classic	15			4145	3088		
	800	Scrambler Enduro	15			4145	3088		
	800	Scrambler Flat Track Pro	16			4145	3088		



	800	Scrambler Full Throttle	15		4145	3088	
	800	Scrambler Icon	15		4145	3088	
	800	Scrambler Urban Enduro	16		4145	3088	
	800	Scrambler-X Desert Sled	17		4145	3088	
	800	Sport	03	06	3093	3035	•
	800	Supersport	03	06	3093	3035	•
	821	Monster	15		4145	3035	•
	821	Monster Dark	15		4145	3035	•
	848	(Rad.cal)	08	10	3093	3035	•
	848	EVO (Rad.cal)	11	12	4113	3035	•
	848	Streetfighter	12		3093	3035	•
	848	Streetfighter S	12		4113	3035	•
	851	Strada	89		3030	3029	•
	851	Strada	91		3030	3141	•
	851	Superbike	90		3030	3029	•
	860	GT			3141	3141	
	860	GT	75	77	3141		
	888	Roche Replica	91		3030	3141	•
	888	SPV	93		3030	3029	•
	888	SP4	92	95	3030	3029	•
	888	SFO			3030	3029	•
	888	SPS	92	95	3030	3029	•
	888	Strada	93		3030	3029	•
	888	Superbike	93		3030	3029	•
	899	Panigale	14	15	4145	3035	•
	900	FE	97		3030	3029	•
	900	GTS	77		3141		
	900	M,IL Monster	93	99	3030	3029	•
	900	Mike Hailwood Replica	85		3141	3141	•
	900	Monster	00	01	3093	3029	•
	900	Monster i.e.	02		3093	3029	•
	900	S2 Desmo	85		3141	3141	•
	900	SL	92	97	3030	3029	•
	900	Sport	77		3141	3141	•
	900	SS	78	89	3141	3141	•
	900	SS	90	94	3030	3029	•
	900	SS Supersport	95	97	3030	3029	•
	900	SSR	92		3030	3029	•
	900	Super Sport	98	02	3093	3035	•
906	900	Paso	89		3141	3029	•
907	900	I. E.	90	93	3030	3029	•
M	900	Street Monster	94	99	3030	3029	•
MH	900		00		3093	3029	•
	916	Biposto	94		3030	3029	•
	916	Monster S4	01	03	3093	3029	•
	916	Sport Touring 4	99	01	3093	3035	•
	916	SPS	97	98	3093	3029	•
	939	Hypermotard	16		4145	3035	•
	939	Hypermotard SP	16		4145	3035	•
	939	Hyperstrada	16		4145	3035	•
	939	SuperSport	17		4145	3035	•
	939	SuperSport S	17		4145	3035	•
	944	Sport Touring	98		3093	3035	•
	944	ST2	97		3093	3035	•
	950	Multistrada	17		4145	3027	
	959	Panigale	16		4145	3035	•
D16RR	990	Desmosedici RR	07	08	4113	3035	•

															
992	ST3	04		3093	3035										
992	ST3s ABS	06		3093	3035										
996	SPS	99	01	3093	3029										
996	Monster S4R	04		3093	3029										
996	R	01		3107	3029										
996	ST4s	02	06	3093	3035										
996	ST4s ABS	03	06	3093	3035										
998	S	02		3093	3029										
998	Monster S4Rs	06		3107	3035										
998	R	02		3107	3029										
999	S	03	07	3107	3035										
999	Monster S4R	07		3107	3035										
999	Monster S4RS	07		3107	3035										
999	R (Rad.cal)	03	07	3107	3035										
1000	/6 Mike Hailwood Replica	85		3141	3141										*
1000	Biposto	07		3090	3088										
1000	GT	05	10	3090	3088										
1000	GT Touring	09		3090	3088										
1000	Hypermotard	06		3107	3035										
1000	Mille Replica	84		3141	3141										
1000	Monster Dark i.e., s.i.e.	03	06	3093	3029										
1000	Monster i.e., s.i.e.	03	06	3093	3029										
1000	Monster S2R	06	07	3093	3035										
1000	Multistrada	07		3093	3035										
1000	Multistrada DS	03	06	3093	3035										
1000	Multistrada SDS	05		3093	3035										
1000	Paul Smart	05		3090	3088										
1000	S2 Desmo	85		3141	3141										
1000	Sport, Sport S	05	09	3090	3088										
1000	Supersport DS	03	06	3093	3035										
1098	(Rad. cal)	07	08	4113	3035										
1098	R (Rad.cal)	08		4113	3035										
1098	R Bayliss LE (Rad.cal)	09		4113	3035										
1098	S (Rad. cal)	07	08	4113	3035										
1098	Streetfighter (Rad.cal)	09		4113	3035										
1098	Streetfighter S (Rad.cal)	09		4113	3035										
1100	Hypermotard	07		4113	3035										
1100	Hypermotard EVO	10		3093	3035										
1100	Hypermotard EVOSP	10		4113	3035										
1100	Monster (Rad.cal)	09		3093	3035										
1100	Monster ABS (Rad.cal)	09		3093	3035										
1100	Monster EVO (Rad.cal)	11		3093	3035										
1100	Monster EVO ABS (Rad.cal)	11		3093	3035										
1100	Monster S (Rad.cal)	09		3093	3035										
1100	Monster S ABS (Rad.cal)	09		3093	3035										
1100	Multistrada	07	09	3093	3035										
1100	Multistrada S	07	09	3093	3035										
1198	(Rad.cal)	09		4113	3035										
1198	S (Rad.cal)	09		4113	3035										
1198	SP (Rad.cal)	11		4113	3035										
1199	Panigale	12	14	4113	3035										
1199	Panigale R	13		4113	3035										
1199	Panigale S	12	14	4113	3035										
1199	Superleggera	14		4113	3035										
1200	Multistrada Enduro	16		4145	3090										
1200	Diavel	11		4113	3090										
1200	Diavel Strada	11		4113	3090										



1200	Monster	14	16	4145	3035	•
1200	Monster	17		4145	3035	•
1200	Monster R	16		4113	3035	•
1200	Monster S	14	16	4113	3035	•
1200	Monster S	17		4113	3035	•
1200	Multistrada	10	14	3093	3035	•
1200	Multistrada	15		4145	3027	•
1200	Multistrada S	15		4113	3027	•
1200	Multistrada SD-air	15		4113	3027	•
1200	Multistrada SGT	12	14	3093	3035	•
1200	Multistrada S Pikes Peak	11	14	3093	3035	•
1200	Multistrada S Pikes Peak	16		4113	3027	•
1200	Multistrada S Sport	10	14	3093	3035	•
1200	Multistrada S Touring	10	14	3093	3035	•
1200	Xdiavel	16		4113	3090	•
1200	Xdiavel S	16		4113	3090	•
1299	Panigale	15		4113	3035	•
1299	Panigale R	15		4113	3035	•
1299	Panigale S	15		4113	3035	•
1299	Panigale S Anniversario	17		4113	3035	•
1299	Superleggera	17		4113	3035	•

**EASY RIDER**

50	Easy Rider	99		3075	01205	
----	------------	----	--	------	-------	--

**ENDRESS**

EMR	50	95		3087		
-----	----	----	--	------	--	--

**E-TON**







RXL	150	Viper	07		3100	
VXL	250	Vector, ST Vector	06	3074	3100	•
VTX	300	Vortex, ST Vortex	07	3074	3100	•
VXL	300	Vector, ST Vector	07	3074	3100	•

**FACTORY**

50	Helix	04			3074	
50	Rex	04			3074	
R12	50	Phantom Agua	06	3042	3015	
R14	50	Phantom Agua	04	3042	3015	
R14	50	Phantom Aire	03	3015		
RP	50	Desert	04	3017	3015	
SM	50	Chrono	04	3017	3015	
SP	50	Chrono	04	3017	3015	
YR	50	Desert	04	3017	3015	
R2	65	Phantom	04	3042	3015	
100	Helix	04			3074	
100	Rex	04			3074	
YR	125		06	3069	3015	
YR	250		99	3027	3088	

**FANTIC**

50	Caballero Motard	10			3046	
50	Caballero Regularita	10			3046	
50	Big Wheel	93		3076		
50	Fast			3012		
50	Grinta	95		3076		
50	Koala	88		3029	3029	

							
	50	Leader		95	3076		
	50	Oasis		90	3012		
	50	Pony		93	01205	01205	
	50	Pony SR		93	3076	01205	
	50	Queenie		95	3076	01205	
	50	Regolama Casa		08	3017	3074	
	50	Regolama Competizione		08	3050	3087	
	50	Supersei Motard		08	3017	3074	
	50	Trial			3013		
	50	Trial .5 .7 .9		89	3015	3015	
MX	50	Regolama Competizione		08	3050	3087	
RC	50	Caballero		91	3029	3029	
RS	50	Caballero		91	3029	3029	
MX	65	Regolama Competizione		08	3050	3087	
	75	Oasis		89	3012		
	80	Regolama Competizione		08	3050	3087	
MX	85	Regolama Competizione		08	3050	3087	
	125	Caballero Motard 2T		10	3050	3046	
	125	Caballero Regularita 4T		10		3046	
	125	Caballero Enduro 2T		12	3050	3046	
	125	Caballero Motard 4T		10		3046	
	125	Regolama Casa		08	3017	3074	
	125	Regolama Competizione		08	3050	3087	
	125	Supersei Motard		08	3017	3074	
	125	Trial			3013		
	125	Trial Professional		87	3013	3013	
	125	Trial Progress 1		87	3013		
HP1	125	Strada		85	3013		
TZ	125	SM		12	3030		
	200	Caballero Motard 4T		10		3046	
	200	Caballero Regularita 4T		10		3046	
	201	Trial			3013		
	201	Trial Progress 2		87	3013		
	241	Trial Progress 2		87	3013		
	243	Trial		87	3013	3013	
	250	Coach		91	3029		
	250	Enduro 4T		16		3046	
	250	K-Roo		93	3015	3015	
	250	Raider		85	3026		
	301	Trial		85	3013		
	301	Trial Progress 2		87	3013		
	303	Trial Professional		87	3013	3013	
	305			89	3015	3015	
	307	Trial		91	3015	3015	
	343	Trial Progress 2		87	3013	3013	
	500	Caballero		17	4145	3088	
<b>GAC</b>							
		New T.T.		87	3015		
<b>GARELLI</b>							
		Ciclone LC, SM		86	3015		
		Urka		91	3029		
		Xo Electric		12	3069	3085	
	50	Flo'		00	3010		
	50	Sahel		91	3012	3015	
	50	Starter		02	3076		



	50	Tiger XLE	86		3029	3029	
	50	Xo	12			3015	
CPR	50		02		3076		
FX	50		02		3076		
GSP	50		12			3015	
KRS	50		02		3099		
PMX	50	Rally	00		3076		
PMX	50	Sport	00		3099		
SR	50	Pony	95		3076		
	125	Flexi	12		3069		
	125	Freeland	02		3099		
	125	Joker 2	02		3069		
	125	Panther	02		3132	3010	
	125	Raider	02		3074		
	125	Tiger XLE	86		3026		
	125	T-Rex	00		3099		
	125	Xo	12		3069	3085	
GTA	125				3029	3029	
GTA	125		83	85	3029		
XR	125	Tiger XRD	85		3029		
	150	Freeland	02		3099		
	150	Joker 2	02		3069		
	150	Panther	02		3132	3010	
	150	Xo	12		3069	3085	
	200	Xo	12		3063	3085	
	250	Panther	02		3132	3010	
	323	Trial	86		3013		

**GAS GAS**

	50	WildHP	04		3027	3027	
EC	50	Boy	01		3039	3039	
EC	50	Rookie	01	04	3055		
EC	50	Rookie	05		3017		
SM	50	Rookie	01		3055		
TXT	50	Boy	01		3039	3039	
TXT	50	Boy	04		3015	3015	
TXT	50	Rookie	02	03	3039	3039	
MC	65		05		3039	3039	
TXT	80	Rookie	02	03	3039	3039	
	125	Delta	91		3015		
	125	Enducross	93		3050	3095	
	125	Pampera	96	03	3015	3015	
	125	Pampera	04		3017	3039	
	125	Trial	91		3015		
EC	125		97	99	3027	3088	
EC	125		00		3050	3087	
MC	125		03		3050	3087	
SM	125		02		3030	3087	
TX	125	Randone	12		3040	3042	
TXT	125	(Formula cal.)	12		4161	3042	
TXT	125		04		3040	3042	
TXT	125	Pro Racing	14			3042	
TXT	125	Pro Replica	13			3042	
	200	Pampera	99		3015	3015	
	200	WildHP	08		3027	3027	
EC	200		99		3027	3088	
EC	200		00		3050	3087	





EC	200			17		3050	3101	
EC	200	Hobby		07	16	3050	3087	
TX	200			97		3015	3015	
TXT	200			04		3040	3042	
	240	WildHP		04		3027	3027	•
	250	Pampera		96	99	3015	3015	
	250	Pampera		02		3017	3039	
	250	Trial		89		3015	3015	
	250	WildHP		08		3027	3027	•
EC	250			97	99	3027	3088	
EC	250			00	11	3050	3087	
EC	250			12	16	3050	3101	
EC	250			17		3050	3101	
EC	250	fse		02		3050	3087	
GT	250	Contact				3015	3015	
MC	250			97	99	3027	3088	
MC	250			00		3050	3087	
SM	250			02		3030	3087	
TXT	250	(Formula cal.)		12		4161	3042	
TXT	250			04		3040	3042	
TXT	250	Pro Racing		14			3042	
TXT	250	Pro Replica		13			3042	
XC	250			17		3050	3101	
TX	270			97		3015	3015	
	280	Pampera		04		3017	3039	
TXT	280	(Formula cal.)		12		4161	3042	
TXT	280			04		3040	3042	
TXT	280	Pro Racing		14			3042	
TXT	280	Pro Replica		13			3042	
	300	WildHP		03		3027	3027	•
EC	300			99		3027	3088	
EC	300			00	11	3050	3087	
EC	300			12	16	3050	3101	
EC	300			17		3050	3101	
TXT	300	(Formula cal.)		12		4161	3042	
TXT	300			04		3040	3042	
TXT	300	Pro		07		3040	3042	
TXT	300	Pro Racing		14			3042	
TXT	300	Pro Replica		13			3042	
TX	320			97		3015	3015	
	325	Halley PXC				3015	3015	
	327	Trial				3015	3015	
GT	327	Contact				3015	3015	
	370	Pampera		96		3015	3015	
	400	Pampera		06		3050	3087	
EC	400	fse		02		3050	3087	
SM	400	fse		02		3030	3087	
	450	WildHP		03		3027	3027	•
EC	450	fse		03		3050	3087	
EC	450	FSR		07	16	3050	3087	
SM	450	fse		03	06	3030	3087	
SM	450	FSR		07		3030	3087	
	515	WildHP		09		3027	3027	•
EC	515	fsr		08	16	3050	3087	

**GENERIC**

	50	Ideo		06	13		01205
--	----	------	--	----	----	--	-------









50	Toxic	07	3017	3010
50	Trigger SM	06	3017	3010
50	Trigger SM Competition	08	3017	3010
50	Trigger X	06	3017	3010
50	Trigger X Competition	08	3017	3010
50	XOR	06	13	01205
125	Zion	08	3070	

**GILERA**

	AJP Caliper incl. pin/spring		3015		
SP	01	90	3031	3029	
50	503	91	3013	3013	
50	Bullit	90	3013		
50	DNA	01	3017	3010	
50	Eaglet	96		01284	
50	Eaglet	97	3010	3075	
50	Easy Moving	96		0266	
50	H@k	99	3015	3015	
50	Ice	02	3010		
50	Rally, R1		3029		
50	Runner	97	05	3010	01284
50	Runner PJ	06	3041	3014	
50	Runner SP	06	3041	3014	
50	Runner SP, Purejet	98	05	3010	3014
50	Sioux	92	3029	3029	
50	Stalker	97	3010	3014	
50	Storm	94	3010	0266	
50	Typhoon	93	95	3010	0266
50	Typhoon	96	3065	0275	
50	Zulu	01	3015	3015	
DT	50 Stalker	01	3010	3014	
GSM	50 Supermotard	01	3015	3015	
NRG	50	94	3010	0266	
R	50	96	3013		
RC	50 Top Rally	90	3029	3029	
RCR	50	04	3015	3015	
SMT	50	04	3015	3015	
	70 Runner Malossi	98	3010		
	80 Typhoon	95	3010	0266	
	125 Apache	91	3065	3085	
	125 Arizona Hawk	86	3029		
	125 Cougar	99	3026		
	125 Crono	92	3031	3029	
	125 DNA	01	3017	3010	
	125 Fast Bike	88	3026		
	125 Freestyle	92	3031	3029	
	125 GSM	00	3015	3015	
	125 HX, HE	83	3029		
	125 KK, KR, KZ	86	3026	3029	
	125 MX1, MRX, SP01		3031	3029	
	125 Nexus	07	3041	3041	
	125 R1, RIS	90	3026	3029	
	125 SP02	90	3031	3029	
	125 Surfer	00	3015	3015	
	125 Typhoon	96	3065	01284	
CX	125	91	3031	3029	
ER	125 Rally	87	3026		



FX	125	Runner	97	99	3055	0300
FX	125	Runner (Grimeca cal.)	00		3017	3014
FX	125	Runner (Hengtong cal.)	00		3041	3014
FX	125	Runner SP (Grimeca cal.)	00		3017	3014
FX	125	Runner SP (Hengtong cal.)	00		3041	3014
MXR	125		90		3026	3029
RC	125	Top Rally	90			3085
RRT	125	Nebraska	87		3026	
RTX	125		86		3026	
RX	125		83		3029	
RX	125	Arizona Hawk	85		3026	
SC	125		06		3142	3015
ST	125	Runner	08	11	3041	3024
ST	125	Runner	12		3041	3014
VX	125	Runner 4T (Grimeca cal.)	01		3017	3024
VX	125	Runner 4T (Hengtong cal.)	01		3041	3024
X1	125		89		3026	
XR2	125		90		3026	3029
FX	150	Runner	97		3055	0300
	175	Mad Mud	02		3017	3010
	180	DNA	01		3017	3010
FXR	180	Runner	97		3055	
FXR	180	Runner	98	99	3017	
FXR	180	Runner (Grimeca cal.)	00		3017	3014
FXR	180	Runner (Hengtong cal.)	00		3041	3014
FXR	180	Runner SP (Grimeca cal.)	00		3017	3014
FXR	180	Runner SP (Hengtong cal.)	00		3041	3014
VXR	180	Runner	01		3041	
VXR	180	Runner 4T (Grimeca cal.)	01		3017	3024
VXR	180	Runner 4T (Hengtong cal.)	01		3041	3024
	200	Arizona Hawk	85		3026	
	200	ER	87		3026	
	200	Fast Bike			3026	3029
	200	RX	83		3029	
	200	Stalker	97		3010	3014
FX	200	Runner	97	98	3055	0300
FX	200	Runner SP	98		3017	3014
RV	200					3029
ST	200	Runner	08		3041	3024
VXR	200	Runner 4T (Grimeca cal.)	01		3017	3024
VXR	200	Runner 4T (Hengtong cal.)	01		3041	3024
	250	Arizona Hawk	86		3029	
	250	Arizona Rally			3026	3029
	250	Arizona Rally	86		3029	
	250	Nexus	07		3041	3041
	250	OregonQuad	07		3085	3037
NGR	250		85			3029
	350	Dakota			3026	
	350	Saturno Bialbero			3030	3029
XRT	350		90		3026	3029
	500	Dakota	86		3026	
	500	Nexus	04		3027	3035
	500	Saturno Bialbero	90		3030	3029
	500	Saturno Piuma	90		3030	3029
RC	500	Fuoco ie	08		3014	3079
RC	500	Fuoco ie (Parking Brake)	08			3191
	600	Nordwest	91		3031	3029

								
	600	Supersport			02	3107	3035	•
RC	600				88	3026	3029	
RC	600	Top Rally			90		3085	
XRT	600				89	3026	3029	
GP	800				08	3027	3041	•
GP	800	(Parking Brake)			08		3191	

**HAO-QING**

	125	2C			02	3187		
--	-----	----	--	--	----	------	--	--

**HARLEY DAVIDSON**

XG	500	Street			14	15	4168	4168	
XG	500	Street			16		3090	3027	
XG	750	Street			14	15	4168	4168	
XG	750	Street			16		3090	3027	
XL	883	C Sportster Custom			04	13	4166	4167	
XL	883	L Sportster Low			06	13	4166	4167	
XL	883	L Super Low			11	13	4166	4167	
XL	883	L Super Low			14			3137	
XL	883	N Iron			13		4166	4167	
XL	883	N Iron			14			3137	
XL	883	R Roadster			10	13	4166	4167	•
XL	883	R Roadster			14			3137	
XL	883	R Sportster			00	03	4165	4165	
XL	883	Sportster			04	13	4166	4167	
XL	883	Sportster Custom			00	03	4165	4165	
XL	883	Sportster R			05	13	4166	4167	•
XLH	883	Sportster			00	03	4165	4165	
XLH	883	Sportster Hugger			00	03	4165	4165	
VRSCA	1130	V-Rod			02	05	4165	4165	•
VRSCA	1130	V-Rod			06		4171	4171	•
VRSCB	1130	V-Rod			04		4165	4165	•
VRSCD	1130	Night Rod			06		4171	4171	•
VRSCR	1130	Street Rod			06		4171	4171	•
XL	1200	C Sportster Custom			04		4166	4167	
XL	1200	C, CA, CB, CP Custom			14			3137	
XL	1200	CX			17			3137	•
XL	1200	L Sportster Low			07		4166	4167	
XL	1200	N Nightster			07		4166	4167	
XL	1200	R Sportster Roadster			04		4166	4167	•
XL	1200	Sportster Custom			00	03	4165	4165	
XL	1200	Sportster Sport			00	03	4165	4165	•
XL	1200	T Super Low			15			3137	
XL	1200	V Seventy-Two			11	13	4166	4167	
XL	1200	V Seventy-Two			14			3137	
XL	1200	X Forty-Eight			11	13	4166	4167	
XL	1200	X Forty-Eight			14			3137	
XLH	1200	Sportster			00	03	4165	4165	
XR	1200				08		4170	4167	•
XR	1200	X			10		4170	4167	•
VRSCAW	1250	V-Rod			08		4171	4171	•
VRSCDX	1250	Night Rod Special			08		4171	4171	•
VRSCF	1250	Muscle			09		4171	4171	
VRSCX	1250	V-Rod			08		4171	4171	•
FLHR/I	1450	Road King			00	06	4165	4165	•
FLHRCI	1450	Road King Classic			00	06	4165	4165	•
FLHRS/I	1450	Road King Custom			04	06	4165	4165	•



FLHT/I	1450	Electra Glide Standard	00	06	4165	4165	•
FLHTC/I	1450	Electra Glide Classic	00	06	4165	4165	•
FLHTCUI	1450	Ultra Classic Electra Glide	00	06	4165	4165	•
FLHX	1450	Street Glide	06		4165	4165	•
FLSTC	1450	Softail	06	07	4165	4165	
FLSTC/I	1450	Heritage Softail Classic	00	04	4165	4165	
FLSTCI	1450	Softail	06		4165	4165	
FLSTF	1450	Fat Boy	06	07	4165	4165	
FLSTF/I	1450	Fat Boy	00	04	4165	4165	
FLSIF	1450	Fat Boy	06		4165	4165	
FLSII	1450	Heritage Softail	06		4165	4164	
FLSTN/I	1450	Softail Deluxe	06		4165	4165	
FLSIS/I	1450	Heritage Springer	00	03		4165	
FLSTSC/I	1450	Springer Softail Classic	06			4165	
FLIR/I	1450	Road Glide Classic	00	06	4165	4165	•
FXD	1450	Dyna Super Glide	00	03	4165	4165	
FXDBI	1450	Dyna Street Bob	06		4165	4165	
FXDC/I	1450	Dyna Super Glide Custom	05	06	4165	4165	
FXDI	1450	35th Anniversary Super Glide	06		4165	4164	
FXDI	1450	Dyna Super Glide	04	07	4165	4165	
FXDL	1450	Dyna Low Rider	00	03	4165	4165	•
FXDLI	1450	Dyna Low Rider	04	06	4165	4165	
FXDS	1450	Dyna Convertible	00	02	4165	4165	•
FXDWG	1450	Dyna Wide Glide	00	03	4165	4165	
FXDWGI	1450	Dyna Wide Glide	04	06	4165	4165	
FXDX	1450	Dyna Super Glide Sport	00	03	4165	4165	
FXDXI	1450	Dyna Super Glide Sport	04	06	4165	4165	
FXDXT	1450	Dyna Super Glide T-Sport	00	03	4165	4165	
FXST/I	1450	Softail Standard	00	05	4165	4165	
FXST/I	1450	Softail Standard	06		4165	4164	
FXSTB/I	1450	Night Train	00	05	4165	4165	
FXSTB/I	1450	Night Train	06		4165	4164	
FXSTD/I	1450	Softail Deuce	00	05	4165	4165	
FXSTD/I	1450	Softail Deuce	06		4165	4164	
FXSTS/I	1450	Softail	05			4165	
FXSTS/I	1450	Softail	06			4164	
FXSTS/I	1450	Springer Softail	00	04		4165	
FLHR	1584	Road King	07		4165	4165	•
FLHR	1584	Road King	08	10	4171	4171	•
FLHRC	1584	Road King Classic	07		4165	4165	•
FLHRC	1584	Road King Classic	08		4171	4171	•
FLHRS	1584	Road King Custom	07		4165	4165	•
FLHT	1584	Electra Glide Standard	07		4165	4165	•
FLHT	1584	Electra Glide Standard	08		4171	4171	•
FLHTC	1584	Electra Glide Classic	07		4165	4165	•
FLHTC	1584	Electra Glide Classic	08		4171	4171	•
FLHTCi	1584	Ultra Electra Glide Classic	08		4171	4171	•
FLHTCU	1584	Ultra Classic Electra Glide	07	10	4165	4165	•
FLHTK	1584	Electra Glide Ultra LTD	10		4171	4171	•
FLHX	1584	Street Glide	07		4165	4165	•
FLHX	1584	Street Glide	08		4171	4171	•
FLSTC	1584	Heritage Softail Classic	07		4165	4164	
FLSTC	1584	Heritage Softail Classic	08		4172	4163	
FLSTF	1584	Fat Boy	07		4165	4164	
FLSTF	1584	Fat Boy	08		4172	4163	
FLSTFB	1584	Fat Boy Special	10		4172	4163	
FLSTN	1584	Softail Deluxe	07		4165	4164	



FLSTN	1584	Softail Deluxe	08		4172	4163	
FLSTSC/I	1584	Softail	07			4164	
FLTR	1584	Road Glide	08		4171	4171	•
FLTRU	1584	Road Glide Ultra	11	16	4171	4171	•
FLTRX	1584	Road Glide Custom	10		4171	4171	•
EXCW	1584	Rocker	08		4172	4163	
EXCWC	1584	Rocker C	08		4172	4163	
EXD	1584	Dyna Super Glide	07		4165	4165	
EXD	1584	Dyna Super Glide	08		4172	4163	
EXDB	1584	Dyna Street Bob	07		4165	4165	
EXDB	1584	Dyna Street Bob	08	13	4172	4163	
EXDC	1584	Dyna Super Glide Custom	07		4165	4165	
EXDC	1584	Dyna Super Glide Custom	08		4172	4163	
EXDF	1584	Fat Bob	08		4172	4163	
EXDL	1584	Dyna Low Rider	07		4165	4165	
EXDL	1584	Dyna Low Rider	08		4172	4163	
EXDWG	1584	Dyna Wide Glide	07		4165	4165	
EXDWG	1584	Dyna Wide Glide	08		4172	4163	
EXST	1584	Softail Standard	07		4165	4164	
EXST	1584	Softail Standard	08	14	4172	4163	
EXST	1584	Softail Standard	15		4170	4163	
EXSTB	1584	Night Train	07		4165	4164	
EXSTB	1584	Night Train	08		4172	4163	
EXSTC	1584	Softail Custom	07		4165	4164	
EXSTC	1584	Softail Custom	08		4172	4163	
EXSTD	1584	Softail Deuce	07		4165	4164	
FLD	1690	Switchback	12		4172	4163	
FLHR	1690	Road King	11	15	4171	4171	•
FLHR	1690	Road King	16		4171	4171	•
FLHRC	1690	Road King Classic	11		4172	4163	
FLHTC	1690	Electra Glide Classic	11		4172	4163	
FLHTCU	1690	Ultra Classic Electra Glide	11	16	4171	4171	•
FLHTCUL	1690	Electra Glide Ultra Classic Low	15		4171	4171	•
FLHTCUTG	1690	Tri Glide Ultra Classic Trike	09	13	4171		•
FLHTK	1690	Ultra Classic Electra Glide	10		4171	4171	•
FLHTK	1690	Ultra Electra Glide	11		4172	4163	
FLHTKL	1690	Ultra Limited Low	15	16	4171	4171	•
FLHX	1690	Street Glide	11	16	4171	4171	•
FLHXS	1690	Street Glide Special	14	16	4171	4171	•
FLHXXX	1690	Street Glide Trike	10		4171		•
FLS	1690	Softail Slim	12	14	4172	4163	
FLS	1690	Softail Slim	15		4170	4163	
FLS	1690	Softail Slim	16		4170	4163	
FLSTC	1690	Heritage Softail Classic	12	14	4172	4163	
FLSTC	1690	Heritage Softail Classic	15		4170	4163	
FLSTF	1690	Fat Boy	12	14	4172	4163	
FLSTF	1690	Fat Boy	15		4170	4163	
FLSTF	1690	Fat Boy Special	12	14	4172	4163	
FLSTFB	1690	Fat Boy	12	14	4172	4163	
FLSTFB	1690	Fat Boy	15		4170	4163	
FLSTN	1690	Softail Deluxe	12	14	4172	4163	
FLSTN	1690	Softail Deluxe	15		4170	4163	
FLTRX	1690	Road Glide	15	16	4171	4171	•
FLTRXS	1690	Road Glide Special	15	16	4171	4171	•
FXDB	1690	Dyna Street Bob	14		4172	4163	
FXDBA	1690	Dyna Street Bob	13		4172	4163	
FXDBB	1690	Dyna Street Bob	14		4172	4163	



FXDBP	1690	Dyna Street Bob	13		4172	4163	
FXDC	1690	Dyna Super Glide Custom	14		4172	4163	
EXDF	1690	Dyna Wide Glide	12		4172	4163	
EXDF	1690	Fat Bob	12		4172	4163	•
EXDL	1690	Dyna Low Rider	14		4172	4163	•
EXDLS	1690	Dyna Low Rider S	17		4172	4163	•
EXS	1690	Blackline	13		4172	4163	
EXSB	1690	Breakout	14		4172	4163	
EXSB	1690	Breakout	15		4170	4163	
FLHR	1750	Road King	17		4171	4171	•
FLHRC	1750	Road King Classic	17		4171	4171	•
FLHTCU	1750	Ultra Classic Electra Glide	17		4171	4171	•
FLHTK	1750	Ultra Limited	17		4171	4171	•
FLHTKL	1750	Ultra Limited Low	17		4171	4171	•
FLHX	1750	Street Glide	17		4171	4171	•
FLHXS	1750	Street Glide Special	17		4171	4171	•
FLTRU	1750	Road Glide Ultra	17		4171	4171	•
FLTRX	1750	Road Glide	17		4171	4171	•
FLTRXS	1750	Road Glide Special	17		4171	4171	•
FLHRSE5	1802	CVORoad King	14		4171	4171	•
FLHTKSE	1802	CVOLimited	14	16	4171	4171	•
FLHXSE	1802	CVOSTreet Glide	10	16	4171	4171	•
FLSS	1802	Softail Slim S	16		4170	4163	
FLSTFBS	1802	Fat Boy S	16		4170	4163	
FLSTNSE	1802	CVOSoftail Deluxe	14		4172	4163	•
FLSTNSE	1802	CVOSoftail Deluxe	15		4170	4163	•
FLTRUSE	1802	CVORoad Glide Ultra	11		4171	4171	
EXGBSE	1802	CVORoad King	13		4172	4163	
FLHTKSE	1870	CVOLimited	17		4171	4171	•
FLHXSE	1870	CVOSTreet Glide	17		4171	4171	•

**HERCULES**

		Silver Star Classic	93		3141		
ZX			86		3029		
	50	Gipsy, Splinter, Reggae	95		3010		
	280	ATV	07		3133		•
	300	ATV Sport	07		3133		•

**HERO ENVOY**

	50		99-		3015		
--	----	--	-----	--	------	--	--

**HIGHLAND**

	450	MX	06		3027	3088	
	950	V2 Motard	00		3027	3088	
	950	V2 Outback	99		3027	3088	

**HM**

CRE	50		98	01		3075	
CRE	50		06	13	3017	3087	
CRE	50	Baja	97	01	3075	3075	
CRE	50	Six Comp.	07	12		3101	
CRM	50	Derapage Comp.	07	12		3101	
	125	Supermotard	00	02	3050	3087	
CR	125	Supermotard	04	06	3050	3046	
CRE	125	Enduro	95	01	3050	3087	
CRE	125	Enduro	02	06	3050	3046	
CRE	125	Six Comp.	10	11		3101	



CRE	125	Supermotard	03		3050	3087
CRM	125	Derapage Comp. 2T	11	12		3101
CRM	125	Derapage Comp. 4T	11	12		3101
CRM	125	X Supermotard	07			3046
	250	Supermotard	00	02	3050	3087
CRE	250	Enduro	95	01	3050	3087
CRE	250	Enduro	02	03	3050	3046
CRE	250	F Enduro	04	13	3050	3046
CRE	250	Supermotard	03		3050	3087
CRE	250	Supermotard	04	07	3050	3046
CRE	250	X Enduro	04	13	3050	3046
CRF	250	Supermotard	04	06	3050	3046
CRM	250	X Supermotard	07	13		3046
CRE	450	F Enduro	02	13	3050	3046
CRE	450	X Enduro	04	13	3050	3046
CRF	450	Supermotard	02	06	3050	3046
CRM	450	X Supermotard	07	13		3046
CRM	500	X Supermotard	07	13		3046

**HONDA**

QA		K1-K3	87		01241	01241
	50	Formula	94		3010	
	50	Giorno	92	94	3132	
	50	Jazz	92		3132	
	50	Sky Classic	00		3010	
	50	Sky Vetro	00		3010	
	50	Tact S	93		3132	
CB	50	all models	80	81	3083	0305
CB	50	all models	81		0305	0305
CB	50	L, K1	75	79		0305
CB	50	Replica	99			3087
CRM	50		88	92	3083	3087
CRM	50		93	96	3132	3087
GP	50	Dio	89	90	3132	
GP	50	Dio	91		3132	
HSC	50	ZR, 01 Scooter	92		3132	
MB	50	S	80	82	3083	0305
MBX	50		80	82	3083	0305
MBX	50	S	83	85	3069	0305
MRX	50		88		3083	0305
MT	50	S	80	93	0305	0305
MTX	50	SC-SD	83	84	0305	0305
NS	50	F, Aero	88		3069	
NS-1	50		91		3069	
NSC	50	Vision	10		3130	
NSR	50		89	90	3069	0305
PA	50		78	81		01241
PA	50		82	83		
PA	50	Camino	80		01241	01241
PC	50	K1	79			
PF	50	M Nocio	75		01241	01241
PK	50	Walaroo DX-STD	90	01		
PX	50		82	83	01241	
PX	50		84		01241	
R	50	Monkey	88		3183	
SC	50	1-ZX	92		3132	
SFX	50	Sport	96		3010	





SGX	50	Sky DX	97		3010	
SH	50	Fifty, Scoopy	00		3010	
SH	50	T	97		3010	
SP	50			91	3083	
SP	50		92		3132	
SR	50	Dio	93		3132	
SR	50	Super Dio	91	92	3132	
SRX	50	Shadow	98		3087	
SXR	50		98		3010	
SZX	50	X8R-S	98		3010	
SZX	50	X8R-X	98		3010	
XL	50				0305	0305
ZX	50	Super Dio	92		3132	
	75	Yupy	90		3087	
CRM	75	R	90	94		3087
NS-1	75		92		3021	3087
NSR	75	FII	88	00	3069	0305
XR	75	K4	75	79	0305	0305
XR	75	K5	79			0305
CB	80		80	81	3083	
CR	80	R	86	91	3106	
CR	80	R, RB	92	02	3106	3087
CR	80	R2	85		0305	0305
CR	80	RA, RB	80	81	0305	0305
CR	80	RC	82		0305	
CRM	80		89		3106	3087
MB	80		80		3075	
MBX	80		83	86	3069	0305
MBX	80		86		3190	0305
MBX	80	DX	82		3069	0305
MBX	80	FWD	83	86	3083	0305
MBX	80	SW, SWD	83		3069	0305
MCX	80		82		3075	0305
MTX	80	R	87		3190	0305
MTX	80	RF	83	84	0305	0305
NH	80	Lead Scooter	86		3183	
NSR	80	R	87	92	3069	3087
NSR	80	R	93		3021	3087
R	80	Lead	88		3183	
XR	80		79	84	0305	0305
CR	85	R, R Expert	03		3106	3087
C	90		93	02	0305	0305
NH	90	Yupy	90	94	3087	0305
SRX	90	Shadow	99		3087	
	100	Lead	00		3190	
CB	100	N	79	80		0305
NSF	100		06		3021	3087
XL	100	all models	78	85	0305	0305
XR	100		81	84	0305	0305
AFS	110	Wave	12		3180	
NHX	110		08	09	3034	
NHX	110		10		3190	
NSC	110	Vision	10	12	3130	
SCV	110	Lead	08	09	3034	
SCV	110	Lead	10	12	3130	
ANF	125	i Innova	07	11	3147	
ANF	125	Innova	03	06	3147	



CA	125	Rebel	95	96	3070	
CA	125	Rebel	97		3026	
CB	125	F	15		3064	
CB	125	J	79			0305
CB	125	RS	83		3083	
CB	125	S	76	78		0305
CB	125	S	79	82	0305	0305
CB	125	T, Superdream	82		3185	
CB	125	TDC	83	89	3186	
CB	125	TT	90		3143	
CBF	125		09		3147	
CBR	125	R	03	10	3147	
CBR	125	R	11	14	3147	3151
CBX	125	Custom	88		3069	0305
CBX	125	F	84	88	3185	
CG	125		04		3083	
CH	125	Spacy	94		3034	
CLR	125	Cityfly	99	03	3026	
CR	125	M2, M3, M4	76	78	0305	0305
CR	125	R	95	01	3050	3087
CR	125	R	02	07	3050	3046
CR	125	RE, RF	84	85	3190	
CR	125	RG	86		3190	
CR	125	RH, RI, RK	87	94		3087
CRE	125		02	07	3050	3046
CRE	125	RR	11		4162	3046
CRF	125	F	14		3050	
CRM	125	R	90	98	3026	3067
CT	125	C	85		0305	0305
FES	125	Pantheon	98	02	3023	
FES	125	Pantheon	03	06	3023	3073
FES	125	S-Wing	07	11	3081	3082
FS	125	Sonic	03		3069	
MBX	125	RWB	84		3069	
MSX	125		14		3147	3151
MT	125	R	77			0305
MT	125	R	78			0305
MTX	125	Camel, Italy	88		3026	
MTX	125	R	84	95	3190	0305
MTX	125	R, Italy	86		3026	0305
MTX	125	RWD	83	84	0305	0305
NES	125	@	01	06	3190	0311
NS	125		89		4136	3183
NS	125	Italy	85	88	3026	
NSR	125	F	88	89	3190	
NSR	125	F, R	90	92	3026	3067
NSR	125	R, Italy	89		3026	3067
NSS	125	Forza	15		3059	3082
NX	125	Transcity	90	98	3026	0305
PCX	125		09		3130	0311
PS	125	i	07	13	3034	0311
R	125	Lead	88		3183	0305
RS	125		95		3030	3183
RS	125	R	91	94	3059	3183
RTV	125	NRS, Italy	87		3026	
SFS	125	Dylan	02	07	3034	0311
SH	125		02	08	3034	0311



SH	125		13		3059	3082
SH	125	i	09	12	3081	3082
SL	125	K1D, E, F, G, K2A	76	80	0305	0305
TL	125		76		0305	0305
VT	125	C1 Shadow	99		3021	
VT	125	C2 Shadow	99		3021	
XL	125	K2	78		0305	0305
XL	125	K3	79			0305
XL	125	R	86		3190	0305
XL	125	R, P.D., Italy	85		3026	0305
XL	125	R, P.D., Italy, EX	87		3026	0305
XL	125	S	79	84	0305	0305
XLR	125	R	98		3050	0305
XLV	125	Varadero	01		3021	
XR	125	L	03		3050	0305
CBR	150	R	00		3147	
CG	150		04		3083	
CRF	150	F	03		3050	0305
CRF	150	R	07		3106	3046
FES	150	Pantheon	99	02	3023	
FES	150	Pantheon	03	06	3023	3073
FES	150	S-Wing	07	11	3081	3082
NES	150	@	01	06	3190	0311
NS	150		92		3087	
NSR	150		02		3021	3063
PCX	150		12		3130	0311
PS	150	i	07	11	3034	0311
SFS	150	Dylan	02	06	3034	0311
SH	150		02	08	3034	0311
SH	150		13		3059	3082
SH	150	i	09	12	3081	3082
CBX	185	Custom	88			0305
XL	185	S	79	83	0305	0305
ATC	200	X	83	85	3106	3106
CTX	200		04		3050	0305
MTX	200	R	85		3190	0305
MTX	200	RWD	83	84	0305	0305
TL	200	L, Y	76	78	0305	0305
TLR	200	G, H	86	87	0305	
XL	200	R	83	84	0305	0305
XL	200	R, P.D., Italy	85		3026	
XR	200		80	84	0305	0305
XR	200	R	84	02	0305	0305
XR	200	R, Pro Link	81	83	0305	0305
CRF	230		04	09	3050	0305
CRF	230	L	08		3050	3087
CRF	230	M	09		3050	3087
SL	230		97	01	3050	3087
	250	Cota 4RT	05	13	3040	3042
	250	Steed	93		3059	
ATC	250	R	81		3083	
ATC	250	R	82	84	3106	3106
ATC	250	R	85	86	3190	3190
ATC	250	X	85		3190	3106
CA	250	Rebel	90		3064	
CB	250		88		3143	
CB	250		92	05	3059	



CB	250	N	78		3052		
CB	250	NA, NB, T, TZ	77		3052		
CB	250	Rebel	86		3069		
CB	250	RS	80	84	3052		
CB	250	RS	85		3190		
CBF	250		04		3021		
CBR	250	Hurricane	87			3073	•
CBR	250	Nighthawk	92		3059		
CBR	250	R (Bybre cal)	11		3090	3088	
CBR	250	R (Nissin cal)	11	13	3059	3155	
CBR	250	R ABS (Nissin cal)	11	13	3081	3155	
CBR	250	R, RR	90		3059	3073	•
CBR	250	RJ	88		3059	3073	•
CBX	250	RSE	84		3186		
CBX	250	S	88		3185		
CD	250	UJ	88	92	3143		
CH	250	Spacy	85	86	3190		
CH	250	Spacy, Freeway Fusion	88		3190		
CM	250	TB	81		3052		
CMX	250	C Rebel	96		3070		
CMX	250	Rebel	85		3069		
CN	250		93		3185		
CN	250	Helix	86	87	3186		
CN	250	Helix (Fusion)	92		3185		
CN	250	Helix (Fusion)	93		3059		
CN	250	Scooter	88	92	3185		
CN	250	Spazio	88	89	3190		
CN	250	Spazio	88	92	3185		
CR	250	R	87	94		3087	
CR	250	R	95	01	3050	3087	
CR	250	R	02	07	3050	3046	
CR	250	RE, RF	84	85	3190		
CR	250	RG	86		3190		
CRE	250		02	07	3050	3046	
CRE	250	F	04		3050	3046	
CRF	250	L	13		4162	3151	
CRF	250	L ABS	17		4162	3151	
CRF	250	M	14		4162	3151	
CRF	250	R	04	09	3050	3046	
CRF	250	R Efi	10		3050	3046	
CRF	250	Rally	17		4162	3151	
CRF	250	X	04		3050	3046	
FES	250	Foresight	98	99	3189		
FES	250	Foresight	00	07	3189	3073	
FTR	250		86		3190	3190	
GB	250	Clubman	88		3186		
NS	250		89		4136	3183	
NS	250	R	85		3185	3186	•
NSR	250	R	87			3186	•
NSR	250	R, SP	90		4136	3073	•
NSR	250	RJ	88		4136	3073	•
NSS	250		00	04	3189	3072	
NSS	250		05		3081	3082	
NSS	250	Forza	00	04	3189	3072	
NSS	250	Forza	05	13	3081	3082	
NSS	250	Jazz	01	04	3189	3072	
PS	250		05		3081		



RS	250	R	91	92	4136	3073	•
RS	250	R	93		3030	3183	•
RTL	250	SG	86		0305	0305	
TL	250	K1	79		0305	0305	
TLM	250	RJ	89		0305	0305	
TLR	250	R	85		0305	0305	
TRX	250	EX Sportrax	01	08	3106		•
TRX	250	R	86	89		3190	•
TRX	250	X	08		3106		•
TRX	250	X Fourtrax	87			3190	•
VT	250	Spada	89		3059	3073	
VTR	250		98	02	3071	3073	
XL	250	R	84	87	3190	0305	
XLR	250	R	88		3190	0305	
XLR	250	R SPL	94		3050	3087	
XR	250	L	91	92		3087	
XR	250	L	93	97	3050	3087	
XR	250	R	84	87	3190	0305	
XR	250	R	88	89		0305	
XR	250	R	90	95		3087	
XR	250	S, R	96		3050	3087	
Cota	260	4Ride	16			3042	
Cota	260	4RT	14		3040	3042	
Cota	260	4RT Race Replica	15			3042	
	300	Rebel	17		3071	3155	
CB	300		10		3021		
CBR	300	F	14		3071	3155	
CBR	300	R	15		3071	3155	
Cota	300	RR	16			3042	
NSS	300	Forza	14		3081	3082	
SH	300	i	07		3081	3082	
SH	300	i SH30	15		3059	3082	
TRX	300	EX Sportrax	01	08	3106	3106	•
TRX	300	X	09		3106	3106	•
XR	300		10		3050	3087	
ATC	350	X	85		3190	3106	
ATC	350	X	86			3106	
NX	350					0305	
XL	350	R	84		3190		
XR	350	R	83			0305	
XR	350	R	84	85	3190	0305	
	400	Xelvis			3186	3186	
CB	400		81		3186	3186	
CB	400	A	77	81	3052		
CB	400	Four	81		3186		•
CB	400	Hawk	81		3186	3186	
CB	400	N	82		3186		•
CB	400	N, T, Hawk	78		3052		
CB	400	Super Four	92	95	3071	3073	•
CB	400	Super Four S	97		3093		•
CB	400	T1, T2	77	78	3052		
CB	400	Twin	82		3186		
CB-1	400	(CB 400 F)	89	90	3059	3073	
CBR	400	F	92			3072	•
CBR	400	F, FII	85		3186	3186	•
CBR	400	R	87			3186	•
CBR	400	RR	87	89	3059	3073	•



CM	400	A, T, TZ	79		3052		
CM	400	C	81		3185		
CM	400	T	79	81	3052		
CM	400	T	82		3186		
FIS	400	Silverwing	06	08	3189	3059	
FIS	400	Silverwing (Parking Brake)	06	08		3191	
GB	400	T.T.	88		3186		
NS	400	R	85	87	3185	3186	•
NTV	400	Bros II	88		4136	3073	
NV	400	Custom	88			3186	
NV	400	Steed	88		3143		
NV	400	Steed	92	93	3059		
RVF	400	RR (NC35)	90	96	4136		•
SW-T	400		09	13	3081	3059	
SW-T	400	ABS	09		3081	3059	
TRX	400	EX Sportrax	01	08	3106	3106	•
TRX	400	Fourtrax EX	99	00	3106	3106	•
TRX	400	X	09	12	3106	3106	•
VF	400	Integra	86		3185	3185	
VFR	400	R	87	88		3073	•
VFR	400	R	89	92	4136		•
VRX	400	T Roadstar	95		3071	3073	
VTR	400	R (NC30)	90		4136		•
XR	400	R	96		3050	3087	
XR	400	Supermotard	00		3050	3087	
TRX	420	FA / HPA	09		3106		•
TRX	420	FPE / FPM4x4	09		3106		•
XR	440	R	00		3050	3087	
CB	450	SC Nighthawk	83	86	3185		
CB	450	T	82		3186		
CM	450	A, C	82		3186		
CMX	450	Rebel	86	88	3186		
CRE	450	F	02		3050	3046	
CRF	450	Efi	09	12	3050	3046	
CRF	450	R	02	08	3050	3046	
CRF	450	R Efi	13	16	3050	3046	
CRF	450	R Efi	17		3050	3046	
CRF	450	RX Efi	17		3050	3046	
CRF	450	X	05		3050	3046	
TRX	450	EX Sportrax	01		3106	3106	•
TRX	450	R	04		3050		•
	500	Rebel	17		3071	3155	
CB	500		94	96	3059		
CB	500		97		3090	3088	
CB	500	F	13		3071	3155	
CB	500	S	98	03	3090	3088	
CB	500	X	13		3071	3155	
CBF	500		04	08	3071	3072	
CBF	500	ABS	04	08	3081	3072	
CBR	500	F (Austria)	87	90		3186	•
CBR	500	R	13		3071	3155	
CR	500	R	87	94		3087	
CR	500	R	95	01	3050	3087	
CR	500	RE, RF	84	85	3190		
CR	500	RG	86		3190		
CX	500		81		3185		•
CX	500	C	81	82	3186		•



CX	500	Euro	82		3185	3185	•
CX	500	Silver W., Turbo	83		3186	3186	•
CX	500	Turbo	82	83	3186	3185	•
FT	500		82		3186	3186	•
GB	500	T.T.	88		3186		
GL	500		82		3185	3186	•
GL	500	D	81	82	3186		•
GL	500	I	81	82	3185		•
NS	500	R	85		3186	3186	•
NX	500	Dominator (Austria)	88	92	3143	3073	
NX	500	Dominator (Austria)	93	96	3143	3073	
NX	500	Dominator (Austria)	97		3027	3088	
VF	500	F, FII	84	86	3186	3186	•
VT	500	C Shadow	83	86	3186	2058	
XBR	500	S	85	89	3186		
XL	500	R	83		3190		
XR	500	R	86		3190		
XR	500	R, Pro Link	83	84	3190	0305	
CB	550	SC	83		3186		
	600	Steed	88	91	3143		
	600	Steed	92		3059		
CB	600	Hornet	98	06	3059	3072	•
CB	600	Hornet	07	12	3059	4114	•
CB	600	Hornet (Japan)	98	99	3112	3072	•
CB	600	Hornet ABS	07	12	3081	3072	•
CB	600	Hornet S	00	03	3059	3072	•
CBF	600	N	04	11	3059	3072	•
CBF	600	N ABS	08	11	3081	3072	•
CBF	600	S	04	11	3059	3072	•
CBF	600	S ABS	08	11	3081	3072	•
CBR	600	F	11		3059	4114	•
CBR	600	F ABS	11		3081	3072	•
CBR	600	F Hurricane	87	90		3186	•
CBR	600	F, Super Sport	91	94		3072	•
CBR	600	F3	95	98	3059	3072	•
CBR	600	F4, F4 Sport	99	06	3112	3072	•
CBR	600	RR	03	04	3112	3072	•
CBR	600	RR (Rad.cal)	05	06	3116	3072	•
CBR	600	RR (Rad.cal)	07		3116	4114	•
CBR	600	RR (Rad.cal) ABS	09		3116	4114	•
CBX	600	E	85		3186		•
FJS	600	Silverwing	01	08	3189	3059	
FJS	600	Silverwing (Parking Brake)	01	08		3191	
FJS	600	Silverwing	09		3081	3059	
FJS	600	Silverwing (Parking Brake)	09			3191	
NTV	600	Bros I	88		4136	3073	
NTV	600	Revere	88	92		3073	
NV	600	C	88		3143		
SW-T	600		11	13	3081	3059	
VT	600	C Shadow	88	93	3143		
VT	600	C Shadow	94	00	3059		
VT	600	CD Shadow VLX	94	00	3059		•
XL	600	LM, RM	85		3186		
XL	600	R	83	87	3190		
XL	600	V, Transalp	87	90	3186		
XL	600	V, Transalpino	91	93	3143	3073	
XL	600	V, Transalpino	94	96	3071	3073	



XL	600	V, Transalpino	97	99	3050	3073	•
XLM	600	LM	87		3190		
XR	600	R	83	87	3190	0305	
XR	600	R	88	90		0305	
XR	600	R	91	92		3087	
XR	600	R	93	00	3050	3087	
CB	650		79	81	3052		
CB	650		85		3186		•
CB	650	C	80		3052	2027	
CB	650	F	14		3071	3155	•
CB	650	SC Nighthawk	83	85	3186		•
CB	650	Z	78	81	3052		•
CBR	650	F	14		3071	3155	•
CBR	650	F ABS	14		3071	3155	•
CBX	650	ED, SC, SCD	83		3186		•
CX	650	C	83		3186		•
CX	650	E	83		3185	3186	•
CX	650	Turbo	83		3186	3186	•
FMX	650		05	08	3059	3072	
FX	650	Vigor	99	02	3090	3088	
GL	650	D	83	84	3186		•
NT	650	Hawk GT	88	91	3059	3073	
NT	650	V Deauville	98	00	3090	3073	•
NT	650	V Deauville	01		3090	3072	•
NT	650	V Deauville	02	05	3189	3189	•
NTV	650		94		3071	3073	•
NTV	650	Bros	88	97	4136	3073	•
NTV	650	Revere	88	93	3059	3073	
NX	650	Dominator	93	96	3143	3073	
NX	650	Dominator	97	99	3090	3088	
NX	650	Dominator J-K	88	92	3143	3073	
SLR	650		97	99	3090	3088	
XL	650	V Transalp	00	07	3050	3073	•
XR	650	L	93	12	3050	3087	
XR	650	R	00	11	3050	3087	
XRV	650	Africa Twin	88	89	3143	3073	
DN-01	680		08		3081	3071	•
DN-01	680	(Parking Brake)	08			3191	
CB	700	SC	84	86	3186	2046	•
CIX	700		14		3071	3155	
CIX	700	D ABS w/DCT	14		3071	3155	
CIX	700	D ABS w/DCT (Parking Brake)	14			3191	
CIX	700	N	14		3071	3155	
CIX	700	ND ABS w/DCT	14		3071	3155	
CIX	700	ND ABS w/DCT (Parking Brake)	14			3191	
NC	700	D Integra	12	13	3081	3072	
NC	700	D Integra w/DTC (Parking Brake)	12	13		3191	
NC	700	S	12	13	3059	3073	
NC	700	SA ABS	12	13	3081	3072	
NC	700	SD ABS	12	13	3081	3072	
NC	700	SD ABS w/DTC (Parking Brake)	12	13		3191	
NC	700	X	12	13	3059	3073	
NC	700	XA ABS	12	13	3081	3072	
NC	700	XD ABS	12	13	3081	3072	
NC	700	XD ABS w/DCT (Parking Brake)	12	13		3191	
NT	700	Deauville ABS	06	12	3081	3189	•
NT	700	V Varadero, ABS	10		3081	3189	•





TRX	700	XX	08	3050	.
VF	700	C Magna	84	3186	.
VF	700	C Magna	85 86	3185	.
VF	700	C Magna	87	3186	.
VF	700	F Interceptor	84 85	3185 3186	.
VF	700	S	84 85	3186	.
VFR	700	F Interceptor	88 89	3059 3073	.
VFR	700	F, F2	86 87	3143 3186	.
VT	700	C Shadow	87	3186	.
XL	700	Transalp	08 11	3050 3073	.
XL	700	Transalp ABS	08	3081 3072	.
	750	A-ADV	17	4176 3155	.
	750	A-ADV (Parking Brake)	17	3191	.
CB	750	C	80 81	3052	.
CB	750	C	82	3186	.
CB	750	C, F, FI, K	85	3186	.
CB	750	F	81 82	3186 3186	.
CB	750	K	81	3186 3186	.
CB	750	K, L	79	3052	.
CB	750	KZ	82	3186	.
CB	750	N, F, Seven Fifty	92 95	3059 3072	.
CB	750	PZ	81	3052	.
CB	750	SC	82 83	3185	.
CBR	750	Hurricane	87	3143 3186	.
CBX	750		84 88	3186 3186	.
CBX	750	F	84 88	3186 3186	.
NC	750	D Integra	14	3071 3155	.
NC	750	D Integra d/DTC (Parking Brake)	14	3191	.
NC	750	S w/DCT	14	3071 3155	.
NC	750	S w/DCT (Parking Brake)	14	3191	.
NC	750	X w/DCT	14	3071 3155	.
NC	750	X w/DCT (Parking Brake)	14	3191	.
NM4	750	Vultus ABS w/DCT	15	3071 3155	.
NM4	750	Vultus ABS w/DCT (Parking Brake)	15	3191	.
NR	750		92	4136 3072	.
NV	750	CG Shadow	86	3186	.
RVF	750	RR (RC-45)	94 98	4136	.
VF	750	C	82	3186	.
VF	750	C CD Magna	94 98	3071	.
VF	750	C Magna	88 93	3186	.
VF	750	F	83 84	3186 3186	.
VF	750	S	85	3186	.
VF	750	Sport	82 83	3186	.
VFR	750	F	86 87	3143 3186	.
VFR	750	F	88 98	3059 3071	.
VFR	750	R	88 93	4136	.
VP	750	CH, Custom	87	3186	.
VT	750	Black Widow	01 03	3071	.
VT	750	C Shadow	86	3186	.
VT	750	C2 Shadow ACE	97 03	3071	.
VT	750	C2 Shadow Spirit	07 11	3071	.
VT	750	C2B	11	3071	.
VT	750	C2S ABS	13	3081 3137	.
VT	750	C4 Shadow	04	3071	.
VT	750	C5 ABS	13	3081 3137	.
VT	750	RS	11	3071	.
VT	750	S	11	3071	.



XLV	750	R	83	85	3186		
XLV	750	R	86	88	3185		
XRV	750	Africa Twin	90	92		3073	
XRV	750	Africa Twin	93	03	3050	3073	•
	800	Crossrunner	11		3081	3129	•
PC	800	Pacific Coast	89	97	3059		•
VFR	800		06	13	3081	3189	•
VFR	800	ABS	06	13	3081	3189	•
VFR	800	F	14		3116	3129	•
VFR	800	FI	98	01	3189	3189	•
VFR	800	V-TEC,ABS	02	05	3189	3189	•
VFR	800	XCrossrunner	15		3116	3129	•
VT	800	C	88		3186		
CB	900	C	82		3186	3186	•
CB	900	F, F2	81	84	3185	3186	•
CB	900	Hornet	02	07	4136	3072	•
CBR	900	RR Fireblade	92	97	4136	3072	•
CBR	900	RR Fireblade	98	03	3112	3072	•
VFR	950	F, Carat	92		3059	3071	•
CB	1000	C	83		3186	3186	•
CB	1000	F (Big One)	93	97	4136	3072	•
CB	1000	R (Rad.cal)	08		3116	3129	•
CB	1000	RABS	08		3081	3129	•
CBF	1000		06	11	3071	3072	•
CBF	1000	ABS	06	11	3081	3081	•
CBF	1000	FABS	15		3081	3072	•
CBF	1000	Limited Edition	09	14	3071	3072	•
CBF	1000	Limited Edition ABS	09	14	3081	3081	•
CBR	1000	F	87	88	3143	3186	•
CBR	1000	F	89	92	3059	3071	•
CBR	1000	RR Fireblade (Rad.cal)	04	05	3116	3072	•
CBR	1000	RR Fireblade (Rad.cal)	06	08	3116	4114	•
CBR	1000	RR Fireblade (Rad.cal) ABS	09		3116	4114	•
CBR	1000	RRSP	14	16	4113	4114	•
CBR	1000	RRSP	17		4113	4114	•
CBR	1000	RRSP2	17		4113	4114	•
CBX	1000		81	82	3185	3186	•
CRF	1000	L Africa Twin	16		4176	3155	•
CRF	1000	L Africa Twin (Parking Brake)	16			3191	
RC213V-S	1000		16		4113	3035	•
VF	1000	F, FII	84	86	3186	3186	•
VF	1000	FII Bol d'Or	85		3186	3186	•
VF	1000	R	84	87	3186		•
VF	1000	R	86		3186	3186	•
VFR	1000		89		3059	3071	•
VT	1000	C	88		3186		
VTR	1000	F Firestorm	97	07	4136	3072	•
VTR	1000	SP-1, SP-2	00	06	3112	3072	•
XL	1000	Varadero	99		3189	3189	•
XL	1000	Varadero	07		3081	3189	•
XL	1000	Varadero (Linked brake system)	00	06	3189	3189	•
XL	1000	Varadero ABS	04		3081	3189	•
CB	1100	EX	14	16	3112	3072	•
CB	1100		13		3081	3072	•
CB	1100	EX	17		3112	3072	•
CB	1100	F	83		3186	3186	•
CB	1100	Hornet	99		3189	3189	•



CB	1100	R	81	83	3186	3186	.
CB	1100	RD	83		3186	3186	.
CB	1100	RS	17			3072	.
CB	1100	X-11	00	03	3189	3189	.
CBR	1100	XX Super Blackbird	96		3189	3189	.
GL	1100	1, DLX Gold Wing	81		3186	3186	.
GL	1100	Gold Wing	82	83	3185	3186	.
ST	1100		90	02	3059	3071	.
ST	1100	A6 ABS-TCSCBS	96		3189	3023	.
ST	1100	ABS-TCSCBS	92	95	3059	3071	.
VF	1100	C	83	86	3185	3186	.
VF	1100	S	84	85	3185	3186	.
VT	1100	C Shadow	87	93	3186		.
VT	1100	C Shadow	94	96	3059		.
VT	1100	C2 Shadow ACE	95		3059	3072	.
VT	1100	C2 Y	00		3059	3072	.
VT	1100	C3 Shadow Aero	98		3059	3072	.
VT	1100	T Shadow	98		3059	3072	.
GL	1200	A, I Gold Wing	84	86	3185	3186	.
GL	1200	DX Gold Wing	86		3185	3186	.
GL	1200	Gold Wing	84	86	3185	3186	.
VFR	1200	F	10			3129	.
VFR	1200	F w/DCT (Parking Brake)	10			3191	.
VFR	1200	XC Crosstourer	12		3081		.
VFR	1200	XDCC Crosstourer w/DCT	12		3081		.
VFR	1200	XDC Crosstourer w/DCT (Parking Brake)	12			3191	.
CB	1300		05		3112	3072	.
CB	1300	R	02	04	3112	3137	.
CB	1300	S	11		3081	3072	.
CB	1300	SF	98	00		3137	.
CB	1300	X-4	97	03	4136	3137	.
CTX	1300		14		3081	3071	.
ST	1300	Pan European, ABS	02	07	3189	3023	.
ST	1300	Pan European, ABS	08		3081	3023	.
VT	1300	CX A Fury	10	12	3059	3072	.
VT	1300	CXA A Fury ABS	10	12	3081	3189	.
VIX	1300	C	04	09	3059	3072	.
VIX	1300	S	03	07	3059	3072	.
GL	1500	A, SE, I Gold Wing	94		3143	3186	.
GL	1500	F6 C Valkyrie	96	02	3059	3071	.
GL	1500	Gold Wing, Gold Wing SE	88		3143	3186	.
GLX	1500		88		3143	3186	.
GL	1800	Gold Wing	01		3189	3023	.
GL	1800	Gold Wing F6B	13		3189	3023	.
VIX	1800		01		3189	3189	.

**HOREX**

	80	Rebell T	86		3141	3141	.
	80	Sport L	86		3141	3141	.
	125	Imperator	96		3141		.
	125	Regent	96		3141		.
	560	E	86		3141	3141	.
	600	Columbus	87		3141	3141	.
VR6	1200		11	16	3093	3063	.
VR6	1200	Cafe Racer	17		4113	3035	.
VR6	1200	Classic	17		4113	3035	.

**HRD**

	50	GS Enduro	00	02	3055	3088
	50	Sonic 2 Supermotard	00	02	3055	3015
	50	Sonic 2 Trail	00	02	3055	3015
	125	Supermotard	00	02	3055	3015
	125	Trail	00	02	3055	3015

**HUSABERG**

		all models	89	92		3095
		all models	93	98	3027	3095
TE	125		13		3027	3056
FE	250		13		3027	3056
TE	250		11	13	3027	3056
TE	300		11	13	3027	3056
	350		91	92		3095
FE	350		13		3027	3056
FE	390		10	13	3027	3056
FC	400		99	02	3027	3088
FE	400	SE	99	03	3027	3088
FS	400	e, c	01	03	3062	3088
FC	450		03	08	3027	3088
FE	450		09	13	3027	3056
FE	450	e	04	08	3027	3088
FS	450	c	06	08		3088
FS	450	e, c	03	05	3062	3088
FX	450	e	03	08	3027	3088
FC	470	e	01	02	3027	3088
FX	470	e	01	02	3027	3088
	500		91	98		3095
	501	Enduro				3095
FC	501		99	01	3027	3088
FE	501	SE	99	04	3027	3088
FE	501		13		3027	3056
FC	550		01	05	3027	3088
FE	550	e	04	08	3027	3088
FE	570		09	13	3027	3056
	600	Enduro				3095
FC	600		99	01	3027	3088
FE	600	SE	99	02	3027	3088
FE	650	e	01	08	3027	3088
FS	650	e, c	01	05	3062	3088
FS	650	e, c	06	08		3088
FX	650	e	01	05	3027	3088

**HUSQVARNA**

		all models CR,TC,TE,WR	92	94	3063	3083
	50	Husky Boy I, R, S	01		3015	
	50	Racing	98		3015	
CR	50	Junior	06		3042	
CR	50	Pro Senior	06		3042	3032
CR	50	Senior	06		3042	3032
SM	50		02		3055	3015
SM	50		10		3042	3032
TC	50		17		3032	3032
WR	50		02		3055	3015
WRS	50		98		3015	
CR	65		12	13	4160	4159



TC	65		17		4160	4160
TC	85		14		4161	4159
CR	125		85	90	3029	
CR	125		96	04	3027	3088
CR	125		05	13	3027	3056
CX	125		84	85	3029	
SM	125	S	09	13	3027	3088
SM	125	S 4T	11	13	3027	3088
SM	125	Supemotard, S	99	13	3027	3088
TC	125		14		3027	3056
TE	125		14		3027	3056
TE	125	4T	11	13	3027	3088
WR	125		96	13	3027	3088
WRE	125		96	13	3027	3088
WRK	125		90			3095
	200	Prof	86		3029	3029
CR	240		84	85	3029	
WRK	240		90			3095
CR	250		85	87	3029	
CR	250		96	04	3027	3088
CR	250		05		3027	3056
CX	250		84	85	3029	
FC	250		14		3027	3056
FE	250		14		3027	3056
TC	250		02	03	3027	3088
TC	250		04	13	3027	3056
TC	250		14		3027	3056
TE	250		02	13	3027	3088
TE	250		14		3027	3056
TE	250	4T	10	13	3027	3056
WR	250		96	13	3027	3088
TC	300		14		3027	3056
TE	300		14		3027	3056
WR	300		09	13	3027	3056
TE	310	4T	10	13	3027	3056
FC	350		14		3027	3056
FE	350		14		3027	3056
TE	350		96	13	3027	3088
TE	350	Enduro	90			3095
WR	360		98	13	3027	3088
	400	Enduro	85		3029	
SM	400	R	02		3030	3088
TE	400		01	13	3027	3088
	401	Svartpilen	17		3154	3088
	401	Vitpilen	17		3154	3088
TE	410		96	13	3027	3088
	430	Enduro	85		3029	
SMR	449		11		3107	3056
TC	449		11	13	3027	3056
TE	449		11	13	3027	3056
FC	450		14		3027	3056
FE	450		14		3027	3056
FS	450		15		4113	3056
SM	450	R	03	04	3030	3088
SM	450	R	05		3107	3088
SM	450	R	06		3107	3056
SM	450	RR	06		3107	3056



TC	450		02	03	3027	3088
TC	450		04	10	3027	3056
TE	450		02	10	3027	3088
TE	450		14		3027	3056
CR	500		86		3029	
CX/CR	500		84	85	3029	
TC	500		86		3029	
FE	501		14		3027	3056
	504		83		3029	
	510		90			3095
SM	510	Centennial	06		3107	3056
SM	510	R	05		3107	3088
SM	510	R	06		3107	3056
TC	510		02	03	3027	3088
TC	510		04	10	3027	3056
TE	510		86	87	3029	
TE	510		02	10	3027	3088
TE	510	Centennial	04	05	3027	3088
SMR	511		11		3107	3056
TE	511		11	13	3027	3056
TE	511		14		3027	3056
	570	Nox	01	03	3093	3088
SM	570	R	01		3030	3088
TC	570		01	13	3027	3088
TE	570		01	13	3027	3088
LT	610		00		3093	3088
SM	610	ie	07		3107	3056
SM	610	Super Motard, S	98		3093	3088
TC	610		96	13	3027	3088
TE	610	Rallye	96	13	3027	3088
SM	630		10		3107	3056
SMR	630		04	08	3093	3088
TE	630		10	13	3027	3056
TE	630		14		3027	3056
STR	650	CRC	07		3107	3056
TR	650	Strada	13		3090	3088
TR	650	Terra	13		3090	3088
FE	701	Enduro	17		3090	3088
SM	701	Supemoto	15		3107	3088
	900	Nuda	12		3093	3088
	900	Nuda R, ABS	12		4113	3088

**HYOSUNG**

	GA-4		99		3061	
	50	Avanti	99		3074	
	50	Rush	97		3074	
	50	Sense	98		3074	
	50	Super Cab	95		3074	
	50	Super Cab Plus	98		3074	
SB	50		00		3074	
SB	50	P	00		3074	
SD	50		00		3074	
SF	50		99		3074	
	100	Cab	98		3074	
EZ	100		00		3074	
	110	Midas Plus	98		3074	
FX	110	110	02		3074	

KR	110	Master	04		3074	
	125	Aquila	00		3063	
	125	Boomer	03		3010	3069
	125	Exceed	02		3010	3069
	125	Grand Prix	98		3010	
	125	Grand Prix Plus	02		3069	
	125	Hyper	99		3010	
	125	V2	99		3059	
GD	125	EXIV	12		3112	3074
GF	125		98			
GPS	125	D	00		3010	
GT	125		07		3069	3069
GT	125	Comet	02	03	3069	
GT	125	Comet	04		3069	3069
GT	125	Naked	13		3069	3069
GT	125	R Supersport	07		3069	3069
GV	125	Aguila	02	04	3069	
GV	125	Aguila	05		3069	
RT	125	Karion	02	06	3069	
RT	125	Karion	07		3069	3069
RX	125		00		3069	
RX	125	SM	07		3069	3069
XRX	125		07		3069	3069
XRX	125	Offroad	99	06	3069	
	150	Exceed	02		3010	3069
	150	Grand Prix	98		3010	
	250	Aquila	00		3059	
GD	250	EXIV-R	15		3112	3020
GT	250	Comet	02			3052
GT	250	Comet	03		3069	3069
GT	250	iR	13	14	3069	3069
GT	250	iR	15		3112	3020
GT	250	P	13		3069	3069
GT	250	R	07		3069	3069
GV	250		02		3069	
GA	300		98		3061	
GT	300	R	16		3112	3020
GV	300		16		3112	3064
TE	400		05	06	3083	
XRX	400		05		3069	3087
RX	450	SM	08		3107	3088
TE	450		07		3083	
	600	Comet	02			3052
	600	Comet	03		3069	
GT	650		04		3069	3069
GT	650	i	13		3112	3069
GT	650	iNaked	15		3112	3069
GT	650	iR	13	14	3112	3069
GT	650	iR	15		3112	3020
GT	650	P	16		3069	3069
GT	650	R	05		3069	3069
GT	650	S	05		3069	3069
GT	650	TTC	07		3069	3069
GT	650	TTC / Custom Trendkiller	07		3069	3069
GT	650	X	07		3069	3069
GV	650	Aguila	04	05	3069	3139
GV	650	Aguila	06		3069	3069



ST	700		11	3112	3069
ST	700	i Deluxe	13	3112	3069

**INDIAN**

1000	Scout Sixty		16		3133
1000	Scout Sixty		17	3090	3088
1130	Scout		15	16	3133
1200	Scout		17	3090	3088
1700	Chief Blackhawk		11	13	3030 3141
1700	Chief Bomber		10	13	3030 3141
1700	Chief Classic		10	13	3030 3141
1700	Chief Dark Horse		10	13	3030 3141
1700	Chief Deluxe		09	13	3030 3141
1700	Chief Roadmaster		09	13	3030 3141
1700	Chief Standard		09	13	3030 3141
1700	Chief Vintage		09	13	3030 3141
1800	Chief Classic		14		4120 3071
1800	Chief Vintage		14		4120 3071
1800	Chieftain		14		4120 3071
1800	Dark Horse		16		4120 3071
1800	Roadmaster		15		4120 3071
1800	Springfield		16		4120 3071

**ITALJET**

	AIP Caliper incl. pin/spring				3015
	Yankee 8		94		3076 3076
	50 Bazooka		93		3076
	50 Cruise		95		3076
	50 Dragster		99		3015 3015
	50 Formula		94		3025 3010
	50 Formula Air		99		3015
	50 Formula L.C.		98		3015 3015
	50 Jet-Set		02		3048
	50 Pista 2		92		3076
	50 Rollercraft		08		3069 3021
	50 Scoop		93		3076
	50 Torpedo		98		3015
	50 Torpedo 4T		01		3015
SM	50		02		3055
	80 Formula		94		3025 3010
	100 Millennium 2T		01		3074
	100 Millennium 2T		01		3048
	125 Amarcord		08		3087
	125 Dragster		99		3015 3015
	125 Formula		94		3025 3010
	125 Formula L.C.		99		3015 3015
	125 Jet-Set		02		3048
	125 Jupiter		02		3019 3015
	125 Millennium		00		3074
	125 Millennium		00		3048
	125 Torpedo		99		3015
	125 Torpedo		08		3069 3021
	125 Twin		98		3015 3015
SM	125		02		3055
	150 Jet-Set		02		3048
	150 Jupiter		02		3019 3015
	150 Millennium		00		3074





150	Millennium	00	3048	
150	Torpedo	08	3069	3021
150	Torpedo 4T	01	3015	
180	Dragster	99	3015	3015
250	Jupiter	01	3019	3043
350		83	3029	•
650	Bazooka	06	3069	3069 •
650	Grifon	06	3069	3069 •
900	Grifon	00	3030	

**J. J. COBAS**

TR1		85	3030	3015
Trial		85	3015	

**JAWA**

CZ	125	2T		3141
CZ	125	MX		3141
CZ	180		92	3141
	300	Trail	93	3141

**JCM**

		Trial	87	3013	
	125	Europa	89	3015	3015
	125	Oxygene	89	3013	
	125	SR	89	3015	3015
	125	Week-End	89	3013	
	233	Vega	88	3013	
	240	Enduro	91	3013	
	240	Europa	89	3015	3015
	240	Oxygene	89	3013	
	240	SR	89	3015	3015
	240	Week-End	89	3013	
	250	Week-End	91	3013	
	325	Europa	89	3015	
	325	Oxygene	89	3013	
	325	SR	89	3015	3015
	325	Week-End	89	3013	
	333	Vega	87	3013	
	333	Vega	88	3013	

**JIANSHE**

JS	125	3	02	3019
----	-----	---	----	------

**JINCHENG**

JC	125	2A/3A	97	3064
JC	125	2B	97	3087
JC	125	7B	97	3187
JC	150	T-D	06	3019
JC	250		06	3070

**JOHN DEERE**

500	Buck EX, EXT Left/Rear	05	3108	3110
500	Buck EX, EXT Right	05	3110	
500	Buck Left/Rear	05	3108	3110
500	Buck Right	05	3110	
500	Trail Buck Left/Rear	05	3108	3110
500	Trail Buck Right	05	3110	









650	Trail Buck EX, EXT Left/Rear	05	3108	3110
650	Trail Buck EX, EXT Right	05	3110	
650	Trail Buck Left/Rear	05	3108	3110
650	Trail Buck Right	05	3110	







**JOTAGAS**







JT	125		14		3042
JT	250		14		3042
JT	280		14		3042
JT	300		14		3042







**KAWASAKI**







AR	50		81	82	3074
KMX	50		88		3074
KSR	50	I (50)	90	91	3074 3074
KX	65		00		3083
AR	80		81		3074
KD	80		88	90	3074
KMX	80		87		3075
KSR	80	II (80)	90	91	3074 3074
KX	80		84	87	3074
KX	80		88	96	3074 3106
KX	80		97	00	3106
KX	85		01		3106
KX	85	II	01	13	3106
KH	100	EX	88		3095
KH	100	EX, G	81	82	
KH	100	GH	83		3095
KX	100		88	96	3074 3106
KX	100		97		3106
AR	125		82	94	3095
BN	125	Eliminator	98	99	3083
BN	125	Eliminator A3	00		3064
J	125		16		3059 3103
KDX	125		90	94	3074 3086
KE	125		86		3095
KH	125		82	98	3095
KLX	125		10	14	3063 3083
KLX	125	D-Tracker	10	14	3063 3083
KMX	125		86		3074 3095
KMX	125		87	02	3075 3095
KX	125		82		3074
KX	125		83	85	3095
KX	125		86		3095 3095
KX	125		87	88	3095
KX	125		89	93	3063 3086
KX	125		94		3050 3086
KX	125		95	08	3050 3087
Z	125	Pro	17		3180 3083
ZL	125	Eliminator	97		3074
KLX	140	L	08		3063 3106
KLX	150	D-Tracker	16		3063 3083
KLX	150	L	14		3063 3083
KDX	200		93		3063 3086
KDX	200		94	99	3050 3086
KDX	200	C	86	88	3095
KDX	200	SR	89	92	3095 3086

								
KMX	200				88	90	3074	3095
Z	200				83		3095	
KDX	220	R			97		3050	3086
	250	Estrella			92		3095	3095
	250	Versys-X			17		3059	3064
BR	250				86		3061	
CS	250				86		3061	
EL	250				91	94	3061	
EL	250				93	94	3061	
EL	250	Eliminator			88	89	3061	
EX	250	R Ninja			86	87	3061	3061
EX	250	R Ninja			08	12	3064	3064
EX	250	SL Ninja			15		3064	3064
GPZ	250				83		3061	
GPZ	250	Belt Drive			83	84	3095	
GPZ	250	R			86		3061	3061
KDX	250	SR			91	94	3063	3086
KL	250	(KLR 250)			85	97	3095	
KL	250	Super Sherpa			00			3095
KLX	250				93	96	3050	3086
KLX	250				98	07	3050	3087
KLX	250				14		3063	3087
KLX	250	S			09		3063	3087
KLX	250	SF			09		3063	3087
KR	250				85		3095	3061
KR-1	250	S			90		3062	
KSF	250	Mojave			87			3106
KX	250				82		3074	
KX	250				83	85	3095	
KX	250				86		3095	3095
KX	250				87	88		3095
KX	250				89	93	3063	3086
KX	250				94		3050	3086
KX	250				95	08	3050	3087
KXF	250	Tecate			87	88		3106
KX-F	250				04	10	3050	3101
KX-F	250	DFI			11		3050	3101
KXT	250	Tecate			84			3074
KXT	250	Tecate			85	86	3095	3095
KXT	250	Tecate			87			3106
LX	250	Eliminator, SE			90		3061	
SC	250	Epsilon			02		3018	3047
Z	250	A1-A2			79-80			3054
Z	250	A3			81-			3054
J1	250				81-			3054
Z	250	Eliminator			88		3061	
Z	250	I			81			3052
Z	250	SL			15		3064	3064
Z	250	T, Scorpion			89		3095	
ZZR	250				90	01		3095
EL	252				97	00	3061	
EL	252				01		3063	
EX	300	R Ninja, ABS			13		3064	3064
J	300				14		3059	3103
KEF	300	Lakota			95			3106
KLF	300	Bayou			88		3095	
KLF	300	Bayou Left/Rear			89	05	3063	

								
KLF	300	Bayou Right			89 05	3064		
KLX	300	R			97	3050	3087	
KVF	300	Brute Force			13	3083	3133	•
Z	300				15	3064	3064	
EX	305				83	3061		
GPZ	305				81 96	3095		•
GPZ	305				83 96	3061		•
KLR	350				85	3095		
KVF	360	Prairie 2x4, 4x4			03	3083		•
	400	Eliminator			94		3061	
	400	Ninja R Left/Rear			11	3092	3089	
	400	Ninja R Right			11	3091		
EN	400	Twin			85	3061		
EX	400	R			86 88	3095	3061	•
GPZ	400				85 87	3095	3061	•
KFX	400				02	3106	3037	•
KLE	400				91		3095	
KLE	400	Vulcan			90	3061		
KLF	400	Bayou Left			93 99	3063		
KLF	400	Bayou Right			93 99	3064		
KLX	400	R			03	3050	3087	
KLX	400	SR			03	3050	3087	
KVF	400	Prairie			97 98	3083		•
KVF	400	Prairie 2x4			99	3083		•
KVF	400	Prairie 4x4			99	3083		•
LX	400	Eliminator, SE			90	3095		•
Z	400	Eliminator			88	3061	3061	
Z	400	F			84	3095		
ZR	400	F			83 84	3095		
ZR	400	Xanthus (ZR 400D1)			92 95		3095	•
ZX	400				85	3095	3061	
ZX	400				86	3061	3061	•
ZX-4	400				90	3062	3052	•
ZXR	400				89 90	3062	3052	•
ZXR	400				91 02		3052	•
ZZR	400				90 94	3062		•
EN	450				85 90	3061		
KFX	450	Left/Rear			07		3106	
KLX	450	R			07	3050	3101	
KX-F	450				06 08	3050	3101	
KX-F	450	DFI			09	3050	3101	
Z	450	LTD			84	3061		
EN	500				90 96	3061		
EN	500				98	3061		
EN	500	Vulcan			96 97	3061		
ER-5	500				01	3092		
EX	500				94 96		3095	
EX	500	Ninja			94 97		3095	
GPZ	500				93 95	3062		
GPZ	500				95 96	3095	3095	•
GPZ	500				97		3095	•
GPZ	500	R (Austria)			85	3061	3061	•
GPZ	500	S			87	3061		
GPZ	500	S			88	3095		
GPZ	500	S			89 92	3095	3061	•
GPZ	500	S (Austria)			94 96		3095	
GPZ	500	S (Austria)			97		3095	•

								
KL	500	Tengai (Austria)			89	91		3095
KLE	500				91			3095
KLR	500	(Austria)			87	88		3095
KX	500				83	85	3095	
KX	500				86		3095	3095
KX	500				87	88		3095
KX	500				89	93	3063	3086
KX	500				94	95	3050	3086
KX	500				96		3050	3087
ZL	500	(Austria)			85		3061	
ZR	500	(Z 500 F)			83		3095	
ZZR	500	(Austria)			90	92	3062	•
ZZR	500	(Austria)			93		3062	3089
GPZ	550				84	87	3061	3061
GT	550				85	01	3061	•
KX	550	A			83		3095	
Z	550	F			83		3095	•
Z	550	F			85		3061	•
Z	550	GT			83		3095	•
ZR	550	A1,GP			83	84	3095	•
ZR	550	Zephyr			93	99		3089
ZR	550	Zephyr (D) from VIN B024010-			93	01		3089
ZX	550				84		3061	3061
	600	R, Ninja			89		3062	3052
GPZ	600	R			85	89	3061	3061
KL	600				84	86	3095	
KLR	600				84	86	3095	
KLR	600	E			85	94	3095	
Z	600	GP			83		3061	3061
ZL	600				85		3061	
ZX	600	Ninja			85	87	3061	3061
ZX-6R	600	(Ninja ZX6)			93	97	3062	3089
ZX-6R	600	(Ninja ZX6R)			95	97	3062	3089
ZX-6R	600	(ZX6)			90	93	3062	•
ZX-6R	600	Ninja			98	01	3060	3089
ZX-6R	600	Ninja (Rad.cal)			07		4115	3089
ZX-6RR	600	Ninja (Rad.cal)			03	06	4119	3089
ZZR	600				90	92	3062	•
ZZR	600				93	05	3062	3089
ZX-6R	636	Ninja			02		3060	3089
ZX-6R	636	Ninja (Rad.cal)			03	06	4119	3089
ZX-6R	636	Ninja (Rad.cal)			13			4114
	650	Ninja			17		3189	3072
EN	650	Vulcan S			15		3189	3072
EN	650	Vulcan S Cafe			17		3189	3072
EN	650	Vulcan S SE			17		3189	3072
ER-6f	650	Left/Rear			06		3092	3089
ER-6f	650	Right			06		3091	
ER-6n	650	Left/Rear			06	16	3092	3089
ER-6n	650	Right			06	16	3091	
KLE	650	Versys Left/Rear			07	14	3092	3089
KLE	650	Versys Right			07	14	3091	
KLE	650	Versys			15		3059	3155
KLE	650	Versys LT			15		3059	3155
KLR	650				87	07		3095
KLR	650				95	04	3092	3095
KLR	650				08		3063	3064

								
KLR	650	Tengai			89	92		3095
KLX	650				93	96	3050	3086
KLX	650	R			93	95	3050	3086
KLX	650	R D1			96		3050	3087
KVF	650	Brute Force 4x4i Left			05		3063	
KVF	650	Brute Force 4x4i Right			05		3064	
W	650				99		3091	
Z	650				17		3059	3072
VN	700	Vulcan			85		3061	
ZN	700				84		3061	3061
	750	Vulcan			93		3061	
GPZ	750				83	87	3061	3061
GPZ	750	R			85	86	3061	3061
GPZ	750	T			83		3061	3061
GT	750				86		3061	3061
KRF	750	Teryx 4x4 Left			08		3063	
KRF	750	Teryx 4x4 Right			08		3064	
KVF	750	Brute Force 4x4i Left			05		3063	
KVF	750	Brute Force 4x4i Right			05		3064	
VN	750	Vulcan			86	94	3061	
VZ	750	Twin			88		3061	
Z	750	ABS			07	12	3059	3072
Z	750				83	84	3061	
Z	750	Eliminator			88		3061	3061
Z	750	Left/Rear			04	06	3092	3089
Z	750	Right			04	06	3091	
Z	750	LTD Twin			83		3061	3061
Z	750	R			11	12	4115	3155
Z	750	S Left/Rear			05	06	3092	3089
Z	750	S Right			05	06	3091	
Z	750	Turbo			84		3061	3061
ZR	750	Zephyr Left/Rear			96		3092	
ZR	750	Zephyr Right			96		3091	
ZR-7	750	Left/Rear			99		3092	3091
ZR-7	750	Right			99		3091	
ZR-7S	750	Left/Rear			01		3092	3091
ZR-7S	750	Right			01		3091	
ZX	750	E,GP			83	85	3061	3061
ZX-7R	750	Ninja			89	95	3062	3052
ZX-7R	750	Ninja			96	03	3060	3052
ZX-7RR	750	Ninja			96	02		3137
ZXR	750	R			89	95	3062	3052
	800	Mule Pro FX Left			15		3063	
	800	Mule Pro FX Right			15		3064	
KRF	800	Teryx BEF/CEF/DEF Left			14		3063	
KRF	800	Teryx BEF/CEF/DEF Right			14		3064	
KRT	800	Teryx 4 BEF/CEF/DEF Left			14		3063	
KRT	800	Teryx 4 BEF/CEF/DEF Right			14		3064	
VN	800	Classic			98		3092	
VN	800	Drifter			99	02	3092	3091
VN	800	VulcanClassic			95		3061	
W	800				11		3091	
Z	800				13	16	4120	3155
Z	800	ABS			13	16	4120	3155
Z	800	e			13		3059	3155
Z	800	eABS			13	16	4120	3155
GPZ	900	R			84	89	3061	3061

									
GPZ	900	R			90	96	3062		.
VN	900	Classic			06		3092	3091	
VN	900	Classic SE			11		3092	3091	
VN	900	Custom			07		3092	3091	
Z	900				17		4120	3155	.
ZL	900	Eliminator			85	86	3061	3061	.
ZX	900				83	84	3061	3061	.
ZX-9R	900	Ninja			94	95	3062	3089	.
ZX-9R	900	Ninja			96	01	3060	3089	.
ZX-9R	900	Ninja			02	03	4120	3089	.
	1000	H2 Carbon Ninja			17		4113	3035	.
	1000	H2 Ninja			15		4113	3035	.
	1000	H2R Ninja			15		4113	3035	.
	1000	Versys			12		3062	3072	.
	1000	Versys LT			15		3062	3072	.
GPZ	1000	RX			86		3061	3061	.
GTR	1000				86	93	3061	3061	.
GTR	1000				94	06		3061	.
KLV	1000	Left/Rear			04	07	3092	3072	
KLV	1000	Right			04	07	3091		
Z	1000	(Rad.cal)			10	13	3117	3072	.
Z	1000	(Rad.cal)			14		3117	3089	.
Z	1000				03	06	4120	3089	.
Z	1000				07	09	4115	3072	.
Z	1000	R			17		4113	3089	.
Z	1000	R Ninja			86		3061	3061	.
Z	1000	SE (Rad.cal)			14		3117	3089	.
Z	1000	SX (Rad.cal)			11	16	3117	3089	.
Z	1000	SX (Rad.cal)			17		3117	3089	.
ZL	1000				86		3061	3061	.
ZX-10R	1000	Ninja (Rad.cal)			04	07	4119	3089	.
ZX-10R	1000	Ninja (Rad.cal)			08		3117	3089	.
ZX-10R	1000	Ninja (Rad.cal)			11	15	3117	4114	.
ZX-10R	1000	Ninja (Rad.cal)			16		4113	4114	.
ZX-10RR	1000	Ninja (Rad.cal)			17		4113	4114	.
	1100	Zephyr Left/Rear			97		3092		
	1100	Zephyr Right			97		3091		
GPZ	1100	(ZX 1100) Left/Rear			95	99	3092	3089	
GPZ	1100	(ZX 1100) Right			95	99	3091		
GPZ	1100				83		3061	3061	.
GPZ	1100	ABS, Horizont Right			97		3091		
Z	1100	GP			83		3061	3061	.
Z	1100	LTD			85		3061	3061	.
Z	1100	R,LTD			84		3061	3061	.
ZN	1100	LTD			84		3061	3061	.
ZR	1100	Zephyr			92	95	3062		.
ZRX	1100				96	00	3060	3052	.
ZX	1100				93	97	3062	3052	.
ZX	1100	GP			83		3061	3061	.
ZZR	1100				90	93	3062		.
ZZR	1100	GT (ZX 1100 D)			93-			3054	
ZZR	1100				94	01	3062	3052	.
ZG	1200	Voyager XII			86		3061	3061	.
ZRX	1200				01		3060	3052	.
ZRX	1200	R			01		3060	3052	.
ZRX	1200	S			01		3060	3052	.
ZX-12R	1200	Ninja			00	03	3060	3052	.



ZX-12R	1200	Ninja (Rad.cal)	04	06	4119	3052	•
ZZR	1200		02		3062	3052	•
Z	1300		85		3061	3061	•
ZN	1300		83	84	3061	3061	•
ZN	1300	Voy.	85		3061	3061	•
GTR	1400	(Rad.cal)	07		4115	3137	•
ZZR	1400	(Rad.cal)	06	14	4115	3137	•
ZZR	1400	Performance Sport	17		4113	3137	•
ZZR	1400	SE	16		4113	3137	•
VN	1500	Classic	97		3092	3061	
VN	1500	Classic Fi	00		3092	3091	
VN	1500	Classic Tourer Fi Left/Rear	00	-	3092	3091	
VN	1500	Classic Tourer Fi Right	00	-	3091		
VN	1500	Classic Tourer Left/Rear	98		3092	3061	
VN	1500	Classic Tourer Right	98		3091		
VN	1500	Drifter	99	02	3092	3091	
VN	1500	Mean Streak	02	03	3060	3091	
VN	1500	Sumo	88		3061	3061	•
VN	1500	Vulcan	87		3061	3061	
VN	1500	Vulcan, SE	87	92	3061	3061	
VN	1600	Classic Left/Rear	03		3092	3091	
VN	1600	Classic Right	03		3091		
VN	1600	Mean Streak	04		3060	3091	•
VN	1600	Mean Streak	05		4119	3091	•
VN	1700	Classic Left/Rear	09		3092	3091	
VN	1700	Classic Right	09		3091		
VN	1700	Classic Tourer Left/Rear	09		3092	3091	
VN	1700	Classic Tourer Right	09		3091		
VN	1700	Voyager	09		3062	3091	•
VN	2000		04		3062	3091	•

**KEEWAY**

	50	Flash	07		3074	01205	
	50	Flash Electric	10			01205	
	50	Hurricane	06		3074	01205	
	50	Matrix	06			01205	
F-NKD	50		10			01205	
RY8	50		07	09		01205	
RY8	50		10			3069	
TX	50	SM	10		3043		
	90	Hurricane	06		3074		
	100	Partner	06		3021		
	110	Partner	06		3021		
	125	Arn	06		3010		
	125	Enduro	07		3017	3029	
	125	Speed	06		3013	3021	
	125	Superlight	06		3070		
	125	X-Ray	07		3017	3029	
TX	125	SM	10		3043		
	150	Arn	06		3010		
	150	Speed	06		3013	3021	
	150	Superlight	06		3070		
	250	Land Cruiser	06		3070		
	250	Supershadow	06		3019		

**KOTIR**

RS	50		90		01205	01205	
----	----	--	----	--	-------	-------	--





**KRAM-IT**







	50	Scrambler			
	250	SMR	00		3088
GS	250		97	3027	3088
MX	250		97	3027	3088
SM	250		97	3027	3088

**KREIDLER**

	25	Florett XL	99	3075	
	50	Florett	99	3075	01205
	125	Enduro	07	3070	
	125	Florett D	07	3064	
	125	Florett RMC-F	07	3064	
	125	Mustang	83		3029
	125	Supemoto	07	3070	
	200	Enduro	07	3070	







**KTM**

		Baja	86		3029
		Country,Baja	85		3029
		Freeride Electric	12	4161	4159
		GS,EXC,Enduro Models	91		3095
		most models	94	3027	3088
E-SM		Freeride	15	4161	4159
E-SX		Freeride	15	4161	4159
E-XC		Freeride	15	4161	4159
MX		125 600 ccm.	91		3095 3095
		RS, RS4L	86 91		3029
GO	50		94		3012
GP	50	DXL, RS1			3029
GXE	50		87		3029
MX	50		87		3029
RSV	50		86		3029
SM	50	Supemoto	06	3032	3032
SX	50	Adventure	98	01241	01241
SX	50	Pro Junior LC	02	3032	01241
SX	50	Pro Senior LC	02 03	3032	01241
SX	50	Pro Senior LC	04	3032	3032
SX	50	Senior Adventure	04	3032	01241
X-1	50		98		01205
SX	60		99		3015
SX	65		00 01		3015
SX	65		02 03		4160
SX	65		04 08		4160 3032
SX	65		09		4160 4160
	80	RSL, L, RS, RL, Bora, Chopper	80		3029 3029
PL	80	Watercooled			3029 3029
RLW	80		80		3029 3029
MX	85		90		3029
SX	85	(19"/16" wheels)	13	4161	4159
SX	85		04 10	4160	4160
SX	85		11	4160	4159
SX	85		12	4161	4159
	125	Duke	11	3154	3088
	125	Sting	99	3030	3088
	125	SuperMoto	00	3027	3088
EXC	125	Enduro	99 03	3027	3088

								
EXC	125	Enduro			04		3027	3056
EXE	125				00		3027	3088
GS	125				89	90	3095	3095
GS	125				92	97	3027	3095
LC	125				85		3029	
LC	125				86		3029	3029
LC2	125				99		3027	3088
MX	125				85		3029	
MX	125				86		3029	3029
MX	125				89	90	3095	
MX	125				92	93	3027	
RC	125				14		3154	3088
SX	125				96	03	3027	3088
SX	125				04		3027	3056
XC	125				85		3029	
XC	125				86		3029	3029
SX	144				07	08	3027	3056
SX	150				09		3027	3056
	200	Duke			12		3154	3088
EXC	200	Enduro			99	03	3027	3088
EXC	200	Enduro			04		3027	3056
RC	200				14		3154	3088
SX	200				03	04	3027	3056
	250	Baja			86		3029	
	250	Freeride R			14		4161	4159
EXC	250	Enduro			99	03	3027	3088
EXC	250	Enduro			04		3027	3056
EXC	250	Enduro 4T			99	03	3027	3088
EXC	250	Enduro 4T			04	06	3027	3056
EXC-F	250	Enduro			07		3027	3056
GS	250				89	90	3095	3095
LC	250				85		3029	
LC	250				86		3029	3029
MC	250				83	84	3029	3029
MX	250				83	84	3029	3029
MX	250				85		3029	
MX	250				86		3029	3029
MX	250				89	90	3095	
MX	250				92	93	3027	
MX	250	VC, Enduro			87		3031	3031
SX	250				96	02	3027	3088
SX	250				03		3027	3056
SX-F	250				06		3027	3056
XC	250				85		3029	
XC	250				86	89	3029	3029
EXC	300				93	96	3027	3095
EXC	300	Enduro			99	03	3027	3088
EXC	300	Enduro			04		3027	3056
MX	300				90		3095	3095
MX	300				92		3027	3095
XC	300				85		3029	
XC	300				86	90	3029	3029
	350	Country Cross			85		3029	
	350	Freeride			12		4161	4159
	350	GS			83		3029	
EXC	350				87		3031	3031
EXC-F	350				11		3027	3056



GS	350			87		3031	3031
GS4	350	500 K4			83	3029	
K4	350	500 K4			83	3029	
LC4	350			92		3095	3095
MX	350			87		3031	3031
SX-F	350			11		3027	3056
XC	350	MC			83	3029	
MX	360			96	97	3027	3088
SX	360			96	97	3027	3088
XC	360			96	97	3027	3088
EXC	380	Enduro		99		3027	3088
MX	380			98		3027	3088
SX	380			98	02	3027	3088
XC	380			98		3027	3088
	390	Duke		13		3154	3088
	390	GS		83		3029	
RC	390			14		3154	3088
XC	390	MC			83	3029	
	400	Enduro		87		3031	3031
EXC	400	Racing		00	03	3027	3088
EXC	400	Racing		04		3027	3056
LC4	400			93	02	3027	3095
LC4-E	400	Enduro		99	02	3027	3088
SC	400			99		3027	3088
SX	400	Racing		00	02	3027	3088
SXC	400	Tiainen Replica		99	00	3027	3088
XC	420	MC			83	3029	
	450	Rally		11		3090	3088
EXC	450	Racing		04		3027	3056
SX	450	SM Factory Replica		04		3030	3056
SX	450	SMR		04	06		3056
SX	450	SMR		07	12		3056
SX	450	SMR		13		4113	3056
SX-F	450			03		3027	3056
XC-F	450			06		3027	3056
MC	495	Leleu		82	83	3029	
MX	495	Leleu		82	83	3029	
GS	500	500 K4 Enduro		83		3029	
LC	500			85		3029	
LC	500			86		3029	3029
MX	500			85		3029	
MX	500			86		3029	3029
MX	500			87		3031	3031
MX	500			89	91	3095	
MX	500			92	93	3027	
XC	500	MC			83	3029	
SX	505	Racing		07		3027	3056
XC-F	505			08	09	3027	3056
EXC	520	Racing		00	02	3027	3088
SX-F	520	Racing		00	02	3027	3088
EXC	525	Racing		03		3027	3088
EXC	525	Racing		04		3027	3056
SX	525	SMR		04			3056
SX-F	525	Racing		03		3027	3088
SX-F	525	Racing		04	06	3027	3056
EXC	530	Racing		08		3027	3056
SXC	540	Tiainen Replica		99	00	3027	3088

								
LC4	550				87		3031	3031
MX	550				87		3031	3031
SX	560	SMR			06			3056
	600	Duke			93	95	3030	
4T	600	Enduro			84		3029	
EXC	600				87		3031	3031
GS	600				85		3029	
LC4	600				88		3031	3031
LC4	600	Enduro			88		3031	3031
LC4	600	Six Days			92		3027	3095
MC	600				88		3031	3031
MX	600				87		3031	3031
XC	600	Cross			85		3029	
XCE	600	Cross			85		3029	
	620	Duke			96	98	3030	3029
LC4	620	Competition			99		3027	3088
LC4	620	Competition SuperMoto			00		3027	3088
LC4	620	RXC			95		3027	3088
LC4	620	Supercompetition			01		3027	3088
SC	620				99		3027	3088
SX	620				95	99	3027	3088
LC4	625	SC Supermoto			02	04	3027	3088
SMC	625				05		3093	3088
SXC	625				03	04	3027	3088
	640	Duke			99	02	3030	3029
	640	Duke			03	06	3093	3088
LC4	640	Adventure			99	04	3027	3088
LC4	640	Adventure			05	07	3090	3088
LC4	640	Supermoto			03		3030	3088
LC4	640	Supermoto			04		3093	3088
LC4-E	640	Enduro			99		3027	3088
LC4-E	640	Supermoto			99	02	3027	3088
LC4	660	Rallye			01	03	3027	3088
LC4	660	SM Factory Replica			02		3030	3088
SMC	660	Supermoto			03		3030	3088
SMC	660	Supermoto			04	07	3093	3088
	690	Duke			08	11	3107	3088
	690	Duke ABS			12		3093	3088
	690	Duke R			10	11	3107	3088
	690	Duke R			14		4113	3088
	690	Enduro			08		3090	3088
	690	Enduro R			09		3090	3088
	690	SM			07		3107	3088
	690	SMC			08		3107	3088
	690	Supermoto R			08		3107	3088
	950	R Superenduro			06	08	3090	3027
	950	SM			05		3107	3027
	950	SMR			07		3107	3027
LC8	950	Adventure			02	07	3090	3088
	990	Adventure R			10		3090	3027
	990	Adventure, Adventure S, ABS			06	11	3090	3027
	990	Super Duke			04	13	3107	3088
	990	Super Duke R			09	13	3107	3088
	990	Supermoto			07	11	3107	3027
	990	Supermoto R			10		4113	3027
	990	Supermoto T			09		3107	3027
	1050	Adventure			15		3093	3027



	1090	Super Adventure	17		3093	3027	•
	1090	Super Adventure R	17		3093	3027	•
	1190	Adventure	13		3093	3027	•
RC8	1190		08		4113	3035	•
RC8	1190	R	09		4113	3035	•
RC8	1190	RTrack	11		4113	3035	•
	1290	Super Adventure	15	16	3093	3027	•
	1290	Super Adventure R	17		3093	3027	•
	1290	Super Adventure S	17		3093	3027	•
	1290	Super Adventure T	17		3093	3027	•
	1290	Super Duke GT	16		4113	3035	•
	1290	Super Duke R	14		4113	3035	•

**KYMCO**

	50	Agility	05	08	3070		
	50	Agility (4T) R10	06		3070		
	50	Agility (4T) R12	06		3070		
	50	Agility (4T) R16	06		3049		
	50	B&W	04		3021		
	50	Cobra Cross	99	00	3087		
	50	Cobra Cross	01		3087		
	50	Cobra Exclusive	01		3087		
	50	Cobra Racer	99	00	3087		
	50	Cobra Racer	01		3087		
	50	Dink, Dink Sport, B&W	99		3021		
	50	Easy	01		3087		
	50	Filly LX	01		3087		
	50	Filly LX	02		3070		
	50	Heroism	95	96	3087		
	50	K-Pipe	12		3021		
	50	Manboy	95		3183		
	50	MXer	03			3049	
	50	MXU	05			3049	
	50	New Dink	08		3021		
	50	New Sento	11		3070		
	50	Nexon	08		3069	3069	
	50	People	99		3049		
	50	Scout	95		3087		
	50	Sento	08	10	3070		
	50	Spacer	99		3021		
	50	Super-8	08		3049		
	50	Super-9	00	01	3087		
	50	Super-9 A/C	02		3021		
	50	Super-9 L/C	02		3021	3049	
	50	Topboy on/off road	96		3087		
	50	Topboy Racer/Cross	01		3087		
	50	Vitality	04		3070		
	50	Yager	01		3021		
	50	Yup	01		3087		
	50	Yup SP/AL	02		3070		
	50	Zap (Disc Brake version)	95		3183		
	50	ZX 12	06		3087		
CX	50	Curio Super	94		3087		
DD	50	Sniper	94		3087		
K12	50		95		3087		
KB	50		95		3087		
RS	50	Agility Naked	10		3070		



ZX	50	Fever	96	3087	
ZX	50	Super Fever	02	3087	
	90	Manboy	96	3087	
SP	90	Yup	95	3183	
	100	Cobra Racer	99	3021	
	100	Spike	02	3069	
	100	Topboy on/off road	99	3087	
KB	100		99	3087	
	110	Spike	03	3069	
	125	Agility	06	3070	
	125	Agility 16+	14	3049	3021
	125	Agility City	11	3070	3095
	125	B&W, Dink Sport	99	3021	3021
	125	Cruiser	99	3021	
	125	Dink	96	3021	3021
	125	Downtown i	10	3059	3103
	125	G-Dink	12	3059	3102
	125	Grand Dink	02	3021	3021
	125	Hipster	01	3021	
	125	Jetix	08	3069	
	125	K-Pipe	13	3021	
	125	K-XCTi	14	3096	3102
	125	Like	11	3070	
	125	Movie	99	3021	
	125	Movie XL	01	3021	
	125	MXer	03		3049
	125	New Dink	08	3021	3021
	125	New Downtown	16	3096	3103
	125	Nexxon	08	3069	3069
	125	People	01	3049	
	125	People GTi	12	3096	3103
	125	People One i	14	3049	
	125	Pulsar	01	3021	
	125	Quannon	08	3021	3021
	125	Spacer	99	3021	3021
	125	Spike	02	3069	
	125	Stryker on/off	99	3070	
	125	Super Dink	10	3059	3103
	125	Super-8	08	3049	
	125	Super-9	00	3087	3049
	125	Techno GT	06	3021	
	125	Vivio	01	3070	
	125	X-Town	16	3096	3103
	125	Yager	01	3021	3021
	125	Yager GT	09	3021	
	125	Zing	96	3021	
CK	125		04	13	3069
CK-1	125		14		3021
S	125	People	05	3049	3102
	150	B&W	01	3021	3021
	150	Dink	99	3021	3021
	150	Freeway	95	3087	
	150	Grand Dink	02	3021	3021
	150	Hipster	01	3021	
	150	Movie XL	01	3021	
	150	MXer	03		3049
	150	MXU	05		3049



	150	People	01	3049	
	150	Quannon	10	3021	3021
	150	Spacer	99	3021	3021
	150	Straight	08	3069	3069
	150	Stryker Off	01	3070	
	150	Vivio	01	3070	
	150	Yager	01	3021	3021
	150	Zing	99	3021	
DX	150	Custom	93	3069	
NSR	150		93	3069	
	200	Agility 16+	14	3049	3021
	200	Agility R16	11	3049	3021
	200	Dink	04	3021	3021
	200	Downtown i	10	3059	3103
	200	i New Dink	08	3021	3021
	200	Like i	10	3021	3021
	200	People GTi	12	3096	3103
	200	Yager	04	3021	3021
S	200	People	05	3049	3102
	250	B&W, Dink Sport	01	3021	3021
	250	Grand Dink	01	3037	3036
	250	MXU	06	3133	3037
	250	People	03	3021	
	250	Super-9	00	3087	3049
	250	UrbanQuad	06	3133	3037
	250	Venox	01	3059	3059
	250	Xciting	04 05	3059	3059
	250	Xciting	06	3059	3102
	250	Yup	03	3021	3021
KXR	250		04	3133	3037
S	250	People Left/Rear	06	3063	3102
S	250	People Right	06	3064	
	300	Downtown i	10	3059	3103
	300	G-Dink	12	3059	3102
	300	K-XCTi	12	3096	3102
	300	Maxxer	06	3133	3037
	300	Maxxer Supermoto	15	3133	3037
	300	MXU	06	3133	3133
	300	People Gti	10	3059	
	300	People GTi	12	3096	3103
	300	People Si Left/Rear	08	3070	3102
	300	People Si Right	08	3021	
	300	Xciting Ri	08	3059	3102
	300	X-Town	16	3096	3103
	350	New Downtown	16	3096	3103
	400	Xciting i	12	3098	3140
	500	MXU	06 08	3133	3133
	500	UXV4x4	08	3133	3133
	500	Xciting	04	3059	3140
	500	Xciting i Evo ABS	11	3059	3140
	500	Xciting R ABS	09	3059	3140
AK	550		17	4145	3134
	700	MyRoad ABS	09	3059	3140

**LAVERDA**

	50	Gaicho	92	3029	3029
OR	50	Atlas	86	3029	3029



OR	50	Atlas	90	3029	3029	
	125	Custom	86	3029		
	125	Phoenix	01	3149	3049	
CU	125	Ride	86	3029		
LB	125	Uno	85	3029		
	150	Phoenix	01	3149	3049	
	200	Phoenix	01	3149	3049	
GS	350	Lesmo	86	3029	3029	•
PF	350	Alpino		3029	3029	•
RS	350	Alpino		3029	3029	•
	500	Alpino, S	77	3029	3029	•
SFC	500			3141	3141	•
OR	600	Atlas	86		3029	
SFC	600		86	3141	3141	•
	650		92	3030	3029	•
	650	V-Six	93	3141	3141	•
	668	668	96	3030	3029	
	668	Ghost, Diamante	97	3030	3029	•
	700	El Cid	90	3095	3095	
	750	Cup	98	3030	3029	•
	750	Diamante	97	3030	3029	•
	750	Ghost Strike	97	3030	3029	•
	750	SFormula	97 01	3030	3029	•
	750	S, S Carenata	97	3030	3029	•
	750	Sport	99	3030	3029	•
	750	Strike/Black Strike	99	3030	3029	•
	750	T8	98	3030	3029	•
SF2	750		74 78	3141		•
SF3	750		74 78	3141		•
SF3	750	RGS Corsa, Executive	77	3141	3141	•
TIS	800		99	3030	3035	•
	1000	Iota	76	3141	3141	•
3C	1000	3CE, 3CL	74	3141	3141	•
IOTA	1000		95	3030	3029	
RGS	1000		83	3141	3141	•
RGS	1000	Iota	86	3141	3141	•
SFC	1000	(Rad.cal)	04	3107	3035	•
SFC	1000		85 86	3141	3141	•
TGA	1000	Executive	84	3141	3141	•
	1200	Mirage	78	3141	3141	•

**LEM**

	50	CX2, CX3, RX2, RX3	03	3032	3032	
	50	Flash	94	3076	01205	
	50	Ghibli	90	01205	01205	
	50	R2, R3, R3 XC	03	3032	3032	
RX	65		05	3032	3032	
RX	150		11		3032	

**LONGIN**

LX	110	4	02	3021		
LX	125		02	3021		
LX	150	6	02	3019		

**MACAL**

	50	Flash	99	3010		
AM5/6	50	Trophy	99	3015		





AM5/6	50	Trophy H2O	99	3015
-------	----	------------	----	------

**MACBOR**

XC	50	510 Racing	04	3042	3015
XC	50	512 Pro	04	3042	
XC	50	512 Racing	04	3042	3015
XC	50	512 T	04	3042	
XC	50	515 R 6V	04	3042	3015

**MAICO**

		all models	91		3095
	50	Classic	99	01205	01205
	50	Cruiser	99	3074	01205
	50	Thunderbike I	99	3074	01205
	50	Thunderbike II	99	3074	01205
	50	Trafficjammer	99	01205	01205
C-1	50	Hard Enduro	99	3074	01205
R-1	50	Superbike	99	3074	01205
X-1	50	SuperCross	99	3074	01205
	250	Motocross/Enduro	99	3027	3088
GM	250	LC	85	3029	
MD	250		83	3029	3029
	500	Motocross/Enduro	99	3027	3088
	500	Supemotard	99	3027	3088
GM	500	LC	85	3029	

**MALAGUTI**

		AIP Caliper incl. pin/spring			3015
		Fifty Evolution	91		3015
	50	Centro	93		3012
	50	Cak	00		3010
	50	Cak Twin Disk	02		3010 3010
	50	Enduro	85		3029
	50	Enduro Dure	87 88		3013 3013
	50	Fifty	04		3017 3015
	50	Fifty Full, CX, Top	85		3013
	50	Fifty Mistral	90		3013
	50	Yesterday	97		3010
CH	50		86		3013
CR-1	50	Crosser	95		3013
EL	50	Crosser	97		3010
F-10	50		92 93		3095
F-10	50	Jet-Line	94		3010
F-10	50	Timemachine	03		3010
F-10	50	WAP	02		3010
F-12	50	Phantom	94 98		3013
F-12	50	Phantom A.C.	99		3010
F-12	50	Phantom Digit	02		3010 3010
F-12	50	Phantom L.C.	94 98		3012
F-12	50	Phantom L.C. dd	99		3010 3010
F-12	50	Racing Life	03		3010 3010
F-12	50	Tyre Track	03		3010 3010
F-15	50	Fire Fox	96		3013
F-15	50	Fire Fox L.C.	96		3012
F-15	50	Mechatronic	03		3010 3010
MDX	50	Gold Enduro	87		3012
MLX	50	Enduro	87		3012



MRX	50		89	3029		
NKD	50		04	3017	3015	
NKD	50	Dragon	06	3142	3015	
RST	50		90	3029	3029	
RST	50	Sport	87	3013	3013	
SL	50	Centro	96	3010		
XSM	50		03	3017	3015	
XTM	50		03	3015	3015	
	100	Ciak	00	3010	3010	
F-12	100	Phantom AC	00	3010		
F-12	100	Phantom Twin Disk	02	3010	3010	
	125	Blog	10	3070	3075	
	125	Centro ie	08	11	3070	3085
	125	Ciak, Ciak Master	02	3010		
	125	Madison 3	08	3090	3035	
	125	Phantom Max	04	3017	3020	
	125	Runner	87	3026		
	125	Sport City Cube	08	3026	3020	
F-18	125	Warrior	00	3010	3020	
R	125	Madison	99	3017	3020	
	150	Ciak, Ciak Master	02	3010		
	150	Madison	99	3017	3020	
F-18	150		00	3010	3010	
	160	Blog	10	3070	3075	
	160	Centro ie	08	11	3070	3085
	180	Madison	02	3017	3020	
	200	Phantom Max	04	3017	3020	
	200	Sport City Cube	08	3026	3020	
S	200	Madison	03	3017	3020	
	250	Madison	99	3096	3020	
	250	Madison 3 ie	08	3090	3035	
	250	Password	06	3017	3020	
	250	Phantom Max	05	3017	3020	
	250	Sport City Cube	08	3026	3020	•
RS	250	Madison	05	3017	3020	•
	300	Sport City Cube	08	3026	3020	•
K	400	Madison	02	3096	3020	•
MGX	450	Ronco	87	3013		•
GT	500	Spidermax	04	3026	3035	•
RS	500	Spidermax	09	3026	3035	•

**MALANCA**

	125	Mark	85	3029	
--	-----	------	----	------	--

**MASH**

	125	Cafe Racer	14	3069	3083
	125	Scrambler	13	3187	
	125	Seventy	13	3187	
	125	Seventy Five	14	3069	3083
	250	Cafe Racer	14	3069	3083
	250	Two Fifty	14	3069	3083
	400	Scrambler	13	3059	
	500	Five Hundred	13	3059	

**MBK**

		AIP Caliper incl. pin/spring		3015	
	50	Booster	94	0304	0304



	50	Booster 12'	03	3010	
	50	Booster Naked	04	3010	
	50	Booster Next Gen.	97	3011	0304
	50	Booster Rocket	95 02	3011	0304
	50	Booster Spirit	00	3010	0304
	50	Booster Track	97 02	3011	0304
	50	Equalis	96	3011	01205
	50	Evolis	92	3011	0304
	50	Fizz	93	3011	01205
	50	Flipper	99	3010	0304
	50	Forte	94	3011	01205
	50	Hot Champ	91		0304
	50	Mach G	02	3010	
	50	Nitro	97 10	3011	3016
	50	Ovetto	97 10	3011	0304
	50	Sorriso	92	01205	01205
	50	Stunt	00 10	3016	
	50	Target	92	3076	01205
	50	X-Limit	04	3015	3015
	50	X-Power	04	3017	3015
	75	Active	90	0304	
	80	Evolis	94	3011	01205
	100	Booster	99 02	3076	
	100	Nitro	00 03	3010	
YN	100	Ovetto	00 02	3010	
	125	Doodo	01	3010	
	125	Flame R/F	95 03	3085	01205
	125	Skycruiser	06	3080	3035
XC	125	Waap	08	3152	
XQ	125	Thunder	01	3027	3035
YP	125	Flame X	05	3077	
YP	125	Skyliner	99 00	3027	
YP	125	Skyliner	01	3027	3035
YW	125	Z	10	3146	
	150	Doodo	01	3010	
	150	Skyliner	01	3027	3035
	150	Vertex	97	3085	
XQ	150	Thunder	02	3027	3035
	180	Skyliner	04	3027	3035
	250	Skyliner	00	3019	3022
	300	Kilibre	03	3027	3027
	400	Skyliner	04	3019	

**MEGELLI**

	125	M, R, S	08	3069	3046
--	-----	---------	----	------	------

**MINARELLI**

MR	80			3015	
----	----	--	--	------	--

**MINICAR**

MICROCAR 500	500			3038	
GRECAV 505 EIKE	505			3038	

**MONDIAL**

	1000	EVO (Rad.cal)	04	3107	3035	•
	1000	Piega	03	3107	3035	•
	1000	RZ.Nuda	04	3107	3035	•

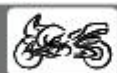

1000 Starfighter (Rad.cal)

04

3107

3035

•

**MONTESA**

	125	Cota	88		3015	3015
	250	Cota 4RT	05	13	3040	3042
	260	Evasion	92		3015	3029
Cota	260	4Ride	16			3042
Cota	260	4RT	14		3040	3042
Cota	260	4RT Race Replica	15			3042
Cota	300	RR	16			3042
	304	Cota	88		3015	3015
	307	Cota	89		3015	3015
	307	Cota Trial	88		3015	3015
	309	Cota	89		3015	3029
	310	Cota	89		3015	3029
	311	Cota Trial	92		3015	3029
	315	Cota R	97		3015	3015
	335	Cota	87	91	3015	3015
	360	315R	01	04	3040	3042
H7	360	Enduro	86		3013	
M7	360	Enduro	85		3015	

**MORBIDELLI**

125 cc 3015 3015 •

**MORIWAKI**

MD 250 09 - 4120 3183







**MOTOBECANE**

50 all models 88 89 01241

**MOTO-GUZZI**

		Ippogrifo	97		3030	3029
	125	Custom	85		3029	
	125	Enduro TT	85		3029	
BX	125		92		3029	3029
	240	4	77		3029	
	250	TS	75	76	3029	
	350		77		3029	3029
	350	Falco	88		3029	3029
	350	Imola	78		3029	3029
	350	Nevada	92		3029	
NIX	350		88		3029	3029
NIX	350		90		3029	3141
V35	350	C			3141	3029
V35	350	Florida			3141	3029
V35	350	GT			3029	
V35	350	GT	90		3141	3029
V35	350	II, Imola, Imola II	77		3029	3029
V35	350	III	87		3141	3141
V35	350	TT	86		3141	3141
	400		79		3029	3029
	500		77		3029	3029
	500	Monza	78		3029	3029
V50	500	1,2,3, Monza Chopper	77		3029	3029
	650		80		3029	3029
	650	Florida			3029	3029

GI	650	Sessantacinque	89		3029	3029	•
NTX	650		90		3029	3141	
V65	650	Florida	86		3141	3141	•
V65	650	GI	90		3141		
V65	650	Lario	86		3029	3029	•
V65	650	NTX	87		3029	3029	
V65	650	SP, Chopper			3029	3029	•
V65	650	TT	86		3029	3029	•
	750	Breva	03		3093	3035	
	750	Nevada	92	96	3029		•
	750	Nevada Classic ie	06		3093	3035	
	750	Nevada, Club/Base	97	02	3029	3029	•
	750	Nevada, Nevada Club	03		3093	3035	
	750	Targa	89		3029	3029	•
NTX	750		89		3029	3029	
NTX	750		90			3141	
S3	750	Left	75	76	3141		
S3	750	Right	75	76	3141		
SP	750		91		3141	3141	
V7	750	Cafe Classic	10		3093	3035	
V7	750	Classic	09	12	3093	3035	•
V7	750	Clubman Racer	10		3093	3035	•
V7	750	Racer	11		3093	3035	
V7	750	Racer	12	14	3093	3026	
V7	750	Stone	12	14	3093	3026	
V7 II	750	Racer	15		3093	3026	
V7 II	750	Scrambler	16		3093	3026	
V7 II	750	Special	15		3093	3026	
V7 II	750	Stone	15		3093	3026	
V7 II	750	Stornello	16		3093	3026	
V7 II	750	Stornello Ltd. Edition	17		3093	3026	
V7 III	750	Anniversario	17		3093	3026	
V7 III	750	Racer	17		3093	3026	
V7 III	750	Special	17		3093	3026	
V7 III	750	Stone	17		3093	3026	
V75	750		86		3141	3141	•
V75	750	Duna	86		3141	3141	
V75	750	TT Paris-Dakar	86		3141	3141	
	850	Le Mans	76		3141	3141	•
T	850		74	76	3141		
T3	850		75		3141	3141	•
T4	850		75		3141	3141	•
T5	850		75		3141	3141	•
T5	850	N.T.	86		3141	3141	•
V9	850	Bobber	16		3093	3026	
V9	850	Roamer	16		3093	3026	
V9	850	X-Track	17		3093	3026	
	940	Custom	07		3093	3090	•
	1000	California II	85	88	3141	3141	•
	1000	California III C	91	95	3141	3141	•
	1000	California III, Fuel Injection	89		3141	3141	•
	1000	Daytona	91		3030	3141	•
	1000	Le Mans IV	85		3141	3141	•
	1000	Le Mans, V	90		3141	3141	•
	1000	Quota	92		3030	3073	•
GT	1000	V	91		3141	3141	•
RS	1000	Daytona	97	00	3030	3029	•

								
S	1000				90	3141	3141	•
SP	1000	III			91	3141	3141	•
SP	1000	Le Mans Left/Rear			79	3141		
SP	1000	Le Mans Right			79	3141		
V	1000	Strada			93	3141	3029	•
V10	1000	Centauro			96 00	3030	3029	•
	1100	California			96	3141	3141	•
	1100	California EV			06	3093	3090	
	1100	California EV Touring			06	3093	3090	
	1100	California Jackal			00	3030	3090	•
	1100	California Jackal			01	3093	3090	•
	1100	California Jackal Basic			00	3030	3090	
	1100	California Jackal Basic			01	3093	3090	
	1100	California Special			99 00	3030	3090	•
	1100	California Special			01	3093	3090	•
	1100	California Special Sport Alloy			02	3093	3090	•
	1100	California Stone Metal			02	3093	3090	
	1100	California Stone, Stone Touring			02	3093	3090	
	1100	California Titanium			03	3093	3090	•
	1100	California Vintage			06	3093	3090	•
	1100	Griso			05	3093	3090	
	1100	Sport			96	3030	3029	•
ES	1100	Quota			99	3090	3027	•
EV	1100	California			97 00	3030	3029	•
EV	1100	California, 80, Touring			01	3093	3029	•
V	1100	Breva			04	3093	3035	
V	1100	Breva, ABS			05 07	3093	3027	
V11	1100	Scura, Sport Scura			02	3093	3029	•
V11	1100	Lemans, Lemans Tenni, Lemans Rosso Corsa			01	3093	3029	•
V11	1100	Sport			97 00	3030	3029	•
V11	1100	Sport Rosso Mandell			01	3093	3029	•
V11	1100	Sport, Sport Naked			01	3093	3029	•
	1200	Griso 8V			07	3093	3027	•
	1200	MGS-01 Corsa (Rad.cal)			05	3107	3035	•
	1200	Norge			06	3093	3027	•
	1200	Norge GT 8V			10	3093	3027	•
	1200	Sport			07 08	3093	3027	•
	1200	Sport 4V			09 11	3093	3035	•
	1200	Sport 8V			12	3093	3027	•
	1200	Sport 8V SE			12	3093	3027	•
	1200	Stelvio			08 11	3093	3027	•
	1200	Stelvio 8V SE			12	3093	3027	•
	1200	Stelvio NTX			09 11	3093	3027	•
V	1200	Breva			08	3093	3027	
	1400	Audace			16	3093	3090	•
	1400	California Custom			13	3093	3090	•
	1400	California Touring			13	3093	3090	•
	1400	California Touring SE			16	3093	3090	•
	1400	Eldorado			16	3093	3090	•
MGX-21	1400	Flying Fortress			16	3093		•

**MOTO-MORINI**

XE	250	Country			88	3029		
	350	Coguardo					3029	
	350	Coguardo, New York			90		3029	
	350	Dart			88		3029	
	350	Dart			90		3029	



	350	Excalibur	87		3026		
	350	Indiana	88			3029	
	350	Kanguro	88		3026	3029	
RLX	350	Excalibur	90			3029	
	400	Dart	89			3029	
	400	Dart	90			3029	
	400	S			3029	3029	•
	500	Sei V Classic	89		3029		•
	501	Camel	88		3026	3029	
	501	Coguardo	89			3029	
	501	Excalibur	87		3026		
	501	Excalibur	89			3029	
	501	New York	89			3029	
RLX	501	Excalibur	90			3029	
	650	Indiana	88			3029	
	750	Indiana	88			3029	
	1200	9 1/2	06	09	3093	3035	•
	1200	Corsaro	06	13	3093	3035	•
	1200	Granferro	10		3107	3027	•
	1200	Granpasso	08		3090	3027	•
	1200	GT	10		3090	3027	•
	1200	Scrambler	09		3090	3027	•
	1200	Sport	08		3093	3035	•

**MOTOR UNION**

JC	125	2B Deer	98		3087		
HK	250	Haake	97		3064		

**MOTORHISPANIA**

		AIP Caliper incl. pin/spring			3015		
MH	50	Furia 6v	99		3015	3015	
MH	50	Furia Max	06		3015	3015	
MH	50	Urban Bike	06		3017	3015	
RX	50	R	08		3142	3187	
RX	50	Racing	00		3055	3015	
RYZ	50	Enduro	05		3015	3015	
RYZ	50	Supermotard	05		3055	3015	
MH7	125	Naked	08		3142	3187	
RX	125	R	08		3142	3187	
RYZ	125	Arena Enduro	05		3015	3015	

**MOTRON**

	50	Spike	97		3010		
	50	Sting	95		3010		
	50	Syncro	97		3010		
	50	Thunder	95		3010		

**MV AGUSTA**

		all models			3141	3141	•
	675	Brutale	12		3093	3035	•
	675	F3	11	12	3093		•
	675	F3	13	14	3093	3035	•
	675	F3	15		4113	3035	•
	675	F3 RC	16		4113	3035	•
	800	Brutale	13		3093	3035	•
	800	Brutale Dragster	15		3093	3035	•
	800	Brutale Dragster RC	17		3093	3035	•



800	Brutale Dragster RR	15		3093	3035	•
800	Brutale RR	15		3093	3035	•
800	F3	14		4113		•
800	F3 RC	16		4113	3035	•
800	Rivale	13		4145	3035	•
800	Stradale	15		4145	3035	•
800	Turismo Veloce	14		4145	3035	•
800	Turismo Veloce Lusso	14		4145	3035	•
800	Turismo Veloce RC	17		4145	3035	•
920	Brutale	12	14	3093		•
989	Brutale R	09		3093		•
990	Brutale R	10	11	3093		•
1000	F4 R	06	07	3107		•
1000	F4 R	12		4113		•
1000	F4 RC	15		4113		•
1000	F4 RR	12		4113		•
1078	Brutale RR	09		4113		•
1078	F4 CC	08	11	4113		•
1078	F4 RR	08	11	4113		•
1090	Brutale Corse	14		4113		•
1090	Brutale R	12		3093		•
1090	Brutale RR	10		4113		•

**MZ**

50	(MUZ) Moskitto	99		3076		
50	(MUZ) Moskitto SX	00		3074		
125	(MUZ) Moskitto	99		3076		
125	Mantizz S	07		3069		
125	Roadstar			3141		
125	SM, SX	99	01		3064	
125	SM, SX	02		3070	3064	
125	Sportstar	93		3141		
ETZ	125	82		3141		
ETZ	125	85		3141		
RT	125	06		3064	3064	
ETZ	150	82		3141		
ETZ	150	85		3141		
ETZ	250	82		3141		
	251 (MUZ) Sportstar	96		3141		
	251 Saxon Tour			3141		
ETZ	251	89		3141		
ETZ	300 LUX	90		3141		
ETZ	300 X	88		3141		
	301 (MUZ) Sportstar	96		3141		
	301 Saxon Tour			3141		
ETZ	301	90		3141		
	500 Saxon Country	92		3141		
	500 Saxon Fun	92		3141		
	500 Saxon Voyager			3141		
	500 Silver Star Classic	93		3141		
	660 (MUZ) Skorpion Cup	99		3030	3029	
	660 (MUZ) Skorpion Replica	97		3030	3029	•
	660 (MUZ) Skorpion Sport	95		3030	3029	
	660 (MUZ) Skorpion Tour	95		3030	3029	
	660 (MUZ) Skorpion Traveller	99		3030	3029	
	1000 (MUZ)S	01	02	3093	3019	•
	1000 (MUZ)S	03		3127	3137	•





1000	(MUZ)SF	05	3127	3137	•
1000	(MUZ)SFX	07	3127	3137	•
1000	(MUZ)SN	05	3127	3137	•
1000	(MUZ)ST	07	3127	3137	•

**NORTON**

	Commander	90	3141	3141	•
	Interpol	83	3141	3141	•
	Wankel Classic	88	3141	3141	•
F-1		90	3030	3141	•
TT		92	3030		•
961	Commando Cafe Racer	11	3107	3035	•
961	Commando SE	10 11	3093	3035	•
961	Commando SE	12	3107	3035	•
961	Commando SF	13	3107	3035	•
961	Commando SF Sport	11	3093	3035	•

**OSSA**

TR	125	i	15	3040	3042
TR	250	i	15	3040	3042
TR	280	i	10	3040	3042
TR	280	i Explorer	12	3040	3042
TR	300	Factory R	15		3042
TR	300	i	15	3040	3042
	500	Yankee	78	3141	3029

**PETERSON**

	50	Hurricane	95	3076	3074
SR	50	Racing	95	3076	3074
	80	Hurricane	95	3076	3074
SR	80	Racing	95	3076	3074

**PEUGEOT**

		AJP Caliper incl. pin/spring		3015	
XPLD		AV	90	3012	
	50	103		01241	01241
	50	104		01241	01241
	50	105		01241	01241
	50	Blaster	09	3015	
	50	Blaster Furios	11	3015	3015
	50	Blaster RS12	09	3015	
	50	Buxy (A.I.P. cal.)	94	3015	
	50	Buxy (Brembo cal.)	94	3010	
	50	Buxy (Hengtong cal.)	94	3075	
	50	CityStar	14	3041	3035
	50	Django Allure	14	3130	
	50	Django Evasion	14	3130	
	50	Django Heritage	14	3063	
	50	Django Sport	14	3130	
	50	Elyseo	02	3015	3015
	50	Elyseo (A.I.P. cal.)	99 01	3015	
	50	Elystar	03	3015	3048
	50	Jet C-Tech	09	3015	3015
	50	Jet-Force	03	3015	3015
	50	Kisbee	10	3075	
	50	Kisbee RS	11	3075	
	50	Looxor	02 05	3015	

								
	50	Looxor			06		3015	3015
	50	Lucix			04		3015	
	50	Speedake (A.I.P. cal.)			94		3015	
	50	Speedake (Brembo cal.)			94		3010	
	50	Speedake (Hengtong cal.)			94		3075	
	50	Speedfight 2 A/C			01		3015	
	50	Speedfight 2 L/C			01		3015	3015
	50	Speedfight 2 L/C Furious, 206 WRC			01		3015	3015
	50	Speedfight 3 (AC)			10		3069	
	50	Speedfight 3 (LC)			10		3069	3035
	50	Speedfight 3 RS (LC)			10		3069	3035
	50	Speedfight 4 (AC)			15		3069	
	50	Speedfight 4 (LC)			15		3069	3035
	50	Speedfight LBD/LBDP			00		3015	3015
	50	Speedfig (A.I.P. cal.)			96		3015	
	50	Speedfig (Brembo cal.)			96		3010	
	50	Speedfig (Hengtong cal.)			96		3075	
	50	Speedfight Lemans			11		3015	3015
	50	Squab (A.I.P. cal.)			94		3015	
	50	Squab (Hengtong cal.)			94		3075	
	50	TKR Furious			05		3015	
	50	TKR WRC			05		3015	
	50	Trekker Metal-X			01		3015	
	50	Trekker Offroad			99		3075	
	50	Trekker Road			99		3015	
	50	Trekker Streetboard			00		3015	
	50	Trekker Urban Black			00		3015	
	50	Tweet			10	13	3099	
	50	Tweet Evo			14		3099	
	50	Tweet Evo RS			14		3099	3014
	50	Tweet RS			10	13	3099	3014
	50	V-Clic			08		3076	
	50	Vivacity			08		3083	
	50	Vivacity (A.I.P. cal.)			99	07	3015	
	50	Vivacity (Hengtong cal.)			05		3075	
	50	Zenith Luxe			94		3010	
SV	50	Geo			92		3087	
SV	50	Geo			93		3087	
SV	50	L			93		3087	
SV	50	Roland Garros			93		3095	
SV	50	Sport			93		3095	
XP 6	50	Enduro			06		3015	3015
XP 6	50	Supermotard			06		3015	3015
XP 6	50	Trail			04	05	3015	3015
XP S-6	50	Enduro			02		3015	3015
XP S-6	50	Supermotard			04		3017	3015
XR 6	50	Race Spec			02	07	3055	3015
XR 7	50				08		3142	3015
SV	80	Geo			91	92	3087	
SV	80	Geo			93		3087	
	100	Elyseo			02		3015	3015
	100	Elyseo (A.I.P. cal.)			99	01	3015	
	100	Looxor			02		3015	3015
	100	Speedfight			00		3015	3015
	100	Speedfight 2, X-Race			01		3015	3015
	100	Trekker Road			99		3015	
	100	Vivacity (A.I.P. cal.)			99	07	3015	



	100	Vivacity (Hengtong cal.)	05	3075	
	125	Active	13	3041	3035
	125	CityStar	11	3041	3035
	125	Django Allure	14	3130	3095
	125	Django Evasion	14	3130	3095
	125	Django Heritage	14	3063	3035
	125	Django Sport	14	3130	3095
	125	Elyseo	00	3017	3048
	125	Elyseo (A.J.P. cal.)	99	3015	
	125	Elystar	03	3017	3048
	125	Geopolis	06	3041	3048
	125	Geopolis (Nissin cal.)	07	3063	3063
	125	Jet-Force Compressor	03	3017	3048
	125	Looxor	03	3189	3048
	125	Lucix	04	3015	
	125	Satelis	04 05	3015	3048
	125	Satelis	06	3017	3048
	125	Satelis ABS	04	3059	3048
	125	Satelis Black Ed.	17	3130	
	125	Tweet	10 13	3099	
	125	Tweet Evo	14	3099	3014
	125	Tweet Evo RS	14	3099	3014
	125	Tweet RS	10 13	3099	3014
	125	Vivacity	10	3063	
GT	125	Satelis Sport	11	3063	3063
LXR	125		10	3099	3100
RS	125	Geopolis	10	3041	3048
SV	125	C Executive	96	3087	
SV	125	Executive	94	3087	
SV	125	Geo	91 92	3087	
SV	125	Geo	93	3087	
XPS	125	CT	06	3015	3015
	150	Django Allure	14	3130	3095
	150	Django Evasion	14	3130	3095
	150	Django Heritage	14	3063	3035
	150	Django Sport	14	3130	3095
	150	Elyseo	00	3017	3048
	150	Elystar	03	3017	3048
	150	Tweet	10 13	3099	
	150	Tweet RS	10 13	3099	3014
	200	CityStar	13	3041	3035
LXR	200		10	3099	3100
	250	Geopolis	06	3041	3041
	250	Satelis	06	3041	3041
	300	Geopolis GT	14	3059	3063
	300	Geopolis Premiu (Nissin cal.)	10	3063	3063
	300	Geopolis RS (Nissin cal.)	10	3063	3063
	300	Geostyle (Nissin cal.)	10	3063	3063
	300	Satelis	13	3063	3063
	400	Geopolis (AJP cal.)	07	3017	3048
	400	Geopolis (Nissin cal.)	07	3063	3063
	400	Geopolis GT	14	3059	3063
	400	Geopolis RS	08	3059	3063
	400	Metropolis	15	4157	4157
	400	Satelis i	14	3059	3063
	500	Satelis	06	3035	3035
	500	Satelis	07	3059	3063



600 Satelis ABS 04 3059 3048

**PGO**

	i-Dep	09		3099	
50	Big Max	94	02	3076	0310
50	Big Max	03		3074	
50	Big Max Sport	96		3076	0310
50	Bugrider	06			3083
50	Comet	91		3074	0310
50	Comet	93		3076	0310
50	Dr. Big	01		3099	
50	FPS	96		3076	
50	Galaxy	91		3074	0310
50	G-Max	06		3099	
50	G-Max Doppler	06		3029	
50	Hot	97		3076	
50	Libra	10		3099	
50	Ligero	06		3099	
50	Mega	96		3076	
50	Road 66	95		3074	
50	Rodoshow	01		3011	
50	Tomado	96		3076	
50	T-Rex	99		3099	
50	T-Rex 3 (TR3-50)	02		3190	
50	X-Rider	03			3074
PMS	50	99		3099	
PMX	50	97	03	3076	
PMX	50	06		3099	
PMX	50	01		3099	
PS	50	93		3074	0310
	80	94		3076	
	90	97		3076	
	90	92		3074	0310
	90	02		3011	
	90	00		3076	
	100	96		3076	0310
	100	02		3099	
	110	99		3099	
PMX	110	00		3076	
	125	02		3099	
	125	03		3070	
	125				3076
	125	10		3063	
	125	06		3099	
	125	02		3099	
	125	96		3076	
	125	99		3099	
	125	99		3099	
	125	10		3063	
	125	03			3074
	150	02		3099	
	150	01		3099	
	150	03			3074
BR	150	05			3083
	250	06		3030	
	500	08	-		3133



BR	500	i Racer	07 -	3133	.
----	-----	---------	------	------	---







**PIAGGIO**

	25	AJP Caliper incl. pin/spring Zip II Cat DT	01		3015	01284
	50	Diesis	02		3015	
	50	Fly	05		3041	0300
	50	Free (Disc Brake version)	97		3010	
	50	HP	92		0128	0128
	50	Liberty	97	14	3014	0300
	50	Liberty 4T	00		3014	0300
	50	New Liberty S	16		3074	
	50	Primavera	14		3041	
	50	Quartz	92		3025	0266
	50	Sfera	91			0266
	50	Sprint	15		3041	
	50	Storm	94	95	3010	0266
	50	Storm	96		3065	0266
	50	Typhoon	94	95	3010	0266
	50	Typhoon	06		3074	
	50	Typhoon Catalyzed	02		3010	3010
	50	V FL2	90		0128	0128
	50	Zip	92	93		0266
	50	Zip & Zip	94		3011	0266
	50	Zip Disco	96		3014	01284
	50	Zip Fast Rider	93	95	3010	0275
	50	Zip Fast Rider	96		3014	01284
	50	Zip II	01		3065	01284
	50	Zip II Cat DT	01		3065	01284
	50	Zip RST	96	97	3014	
	50	Zip RST	98	99	3014	
	50	Zip Sport Production	96		3014	
ET2	50		97		3014	01284
ET4	50		00		3014	01284
LX	50	2T/4T	05		3014	01284
LXV	50		08		3010	
NRG	50		96	00	3065	0275
NRG	50	Extreme	01		3010	
NRG	50	mc2	97	99	3010	0275
NRG	50	mc3 DD	02		3010	3010
NRG	50	mc3 DT	02		3010	
NRG	50	Power DD	05		3010	3010
NRG	50	Power DD	06		3074	3010
NRG	50	Purejet	05		3010	3010
NRG	50	Purejet	06		3074	3010
NRG.1	50		94	95	3010	0266
NTT	50		96			0275
PK	50		83			0128
PK	50	Special	83			0128
PK	50	XL	86			0128
PK	50	XL 2	86		0128	0128
RST	50	Sfera	95		3065	0275
S	50	2T	07		3014	
S	50	4T	09		3014	
S	50	College 4T	11		3010	
TPH	50		93	95	3010	0266
TPH	50		96		3065	0275
TPH	50	2T	11		3041	



	80	Sfera	94			0266	
	80	Skipper	93	95	3025		
	100	Diesis	02		3015		
	100	Fly	07		3041	0300	
	100	Free	02		3010		
	100	Zip	07		3041	0300	
	125	946	14		3041	3024	
	125	Beverly	02		3041	3041	
	125	Canaby	08		3041	3041	
	125	Fly	05		3041	0300	
	125	Hexagon	94	95	3010	01284	
	125	Liberty iGet 4T 3V	17		4162		
	125	Medley	16		4162	3097	
	125	Medley S	17		4162	3097	
	125	MP3	06	07	3014	3079	•
	125	MP3 (Parking Brake)	06	07		3191	
	125	MP3 Efi	08	11	3014	3097	•
	125	MP3 Efi (Parking Brake)	08	11		3191	
	125	MP3 Hybrid	09	12	3014	3097	•
	125	MP3 Hybrid (Parking Brake)	9	12		3191	
	125	MP3 Yourban	11	12	3014	3097	•
	125	MP3 Yourban (Parking Brake)	11	12		3191	
	125	New Liberty	16		4162		
	125	Primavera	14		3041		
	125	Primavera 70	16		3041		
	125	Sfera	95		3014	01284	
	125	Skipper	93	95	3025	01284	
	125	Sprint	16		3041		
	125	Sprint S	17		3041		
	125	Sprint Sport	17		3041		
	125	Typhoon Catalyzed	02		3010	3010	
	125	X10 Executive Left/Rear	13		3041	3097	
	125	X10 Executive Right	13		3097		
	125	X7	08		3041	3097	
	125	X8	04		3041	3035	
	125	X8	05		3041	3079	
	125	X9	01	03	3035	3035	•
	125	X9 Evolution Left/Rear	06		3041	3035	
	125	X9 Evolution Right	06		3097		
	125	X9 Left/Rear	04		3041	3035	
	125	X9 Right	04		3097		
	125	Xevo	08		3041	3097	
	125	Zip II 4T	00		3014	01284	
EI4	125		96		3014	01284	
GT	125	L	04		3041	3024	
GTS	125		07		3041	3024	
GTS	125	Super	10	13	3041	3024	
GTS	125	Super i.e.	15		3041	3024	
GTS	125	Supersport	13		3041	3024	
GIV	125		08		3041	3024	
GTX	125	SuperHexagon (Grimeca cal.)(11" wheels)	00	-	3017	3024	
GTX	125	SuperHexagon (Hengtong cal.)(11" wheels)	00	-	3041	3024	
GTX	125	SuperHexagon (Hengtong cal.)(12" wheels)	01		3041	3024	
LE	125	Liberty	99		3014	0300	
LX	125	4T	05		3014		
LX	125	Hexagon	99		3017	0300	
LX	125	Skipper, ST	99		3017	0300	

LX4	125	Hexagon	99	3017	01284		
LXV	125		08	3010			
PK	125		83	0128	0128		
PK	125	Automatica	84	0128			
PK	125	Special	83	0128	0128		
PK	125	XL	86	0128	0128		
PX	125		78	0128	0128		
PX	125		02	3014			
PX	125	70	16	3014			
PX	125	Arcobalenco	83	0128	0128		
S	125	4T	07	3014			
SKR	125		94	3010			
TPH	125		96	3065	01284		
	150	Fly	06	3041	0300		
	150	Hexagon	94	3010	01284		
	150	Liberty	99	3014	0300		
	150	Medley	16	4162	3097		
	150	Primavera	14	3041			
	150	Skipper	93	3025			
	150	Sprint Veloce	75		0128		
	150	X8 Street	06	3041			
ET4	150		02	3014			
LX	150		08	3010			
PX	150		78	0128	0128		
PX	150		02	3014			
PX	150	Arcobalenco	83	0128	0128		
GS	160		75		0128		
	180	X9	02	3035	3035	•	
GTX	180	SuperHexagon (Grimeca cal.) (11" wheels)	00	3017	3024		
GTX	180	SuperHexagon (Hengtong cal.) (11" wheels)	00	3041	3024		
GTX	180	SuperHexagon (Hengtong cal.) (12" wheels)	01	3041	3024		
LXT	180	Hexagon	99	3017	0300		
SS	180		75		0128		
	200	Beverly	02	3041	3041		
	200	Camaby	08	3041	3041		
	200	Liberty	06	3014			
	200	Rally	75		0128		
	200	X8	04	3041	3035	•	
	200	X8	05	3041	3079	•	
	200	X9	03	3035	3035	•	
BV	200		02	04	3041	3041	
BV	200		05	3041	3017		
GT	200	L	04	3041	3024		
PE	200		83	0128	0128		
PX	200		02	3014			
PX	200	Arcobalenco	83	0128	0128		
PX	200	E	78	0128	0128		
	250	Beverly	07	3041	3041		
	250	GT 60	06	3041	3024		
	250	LX 60	06	3014			
	250	MP3	06	07	3014	3079	•
	250	MP3 (Parking Brake)	06	07		3191	
	250	MP3 Efi	08	09	3014	3097	•
	250	MP3 Efi (Parking Brake)	08	09		3191	
	250	MP3LT iE	09		3014	3097	•
	250	MP3 LT iE (Parking Brake)	09			3191	
	250	X7	08	3041	3097		

							
	250	X8		06	3041	3079	•
	250	X9		00 04	3035	3035	•
	250	X9 Left/Rear		05	3041	3079	
	250	X9 Right		05	3097		
	250	Xevo		08	3041	3097	
BV	250			06	3041	3041	
GT	250	Hexagon		99	3017		
GTS	250	ABS		06	3041	3024	
GTV	250			08	3041	3024	
GTX	250	Super Hexagon		01	3017	3024	
	300	Beverly i.e.		11	3041	3097	
	300	Beverly Tourer		07	3041	3041	
	300	Canaby Cruiser		10	3041	3041	
	300	MP3 Hybrid		11	3014	3097	•
	300	MP3 Hybrid (Parking Brake)		11		3191	
	300	MP3 Hybrid iE		11	3014	3097	•
	300	MP3 Hybrid iE (Parking Brake)		11		3191	
	300	MP3 iE		10	3014	3097	•
	300	MP3 iE (Parking Brake)		10		3191	
	300	MP3LT		13	3014	3097	•
	300	MP3 LT (Parking Brake)		13		3191	
	300	MP3LT Business		13	3014	3097	•
	300	MP3 LT Business (Parking Brake)		13		3191	
	300	MP3LT iE ABS		14	3028	3097	•
	300	MP3 LT iE ABS (Parking Brake)		14		3191	
	300	MP3LT Sport ABS		14	3028	3097	•
	300	MP3 LT Sport ABS (Parking Brake)		14		3191	
	300	MP3LT Touring		11 12	3014	3097	•
	300	MP3 LT Touring (Parking Brake)		11 12		3191	
	300	MP3 Touring		11 12	3014	3097	•
	300	MP3 Touring (Parking Brake)		11 12		3191	
	300	MP3 Yourban iE		11	3014	3097	•
	300	MP3 Yourban iE (Parking Brake)		11		3191	
	300	X7 Evo i.e.		11	3041	3097	
GTS	300	i.e.		12	3041	3024	
GTS	300	Super		09	3041	3024	
GTS	300	Super Sport i.e.		11	3041	3024	
GTS	300	Touring ABS		17	3041	3024	
GTS	300	Touring i.e.		11 12	3041	3024	
GTV	300	i.e.		11	3041	3024	
	350	Beverly S		14	3041	3097	
	350	Beverly Sport Touring ie		12	3096	3097	
	350	Beverly Sport Touring ie ABS		12	3041	3097	
	350	X10 Executive Left/Rear		13	3041	3097	
	350	X10 Executive Right		13	3097		
	350	X10 Executive (Parking Brake)		13		3191	
BV	350			12	3041	3097	
	400	MP3 iE		07 10	3014	3041	•
	400	MP3 iE (Parking Brake)		07 10		3191	
	400	MP3LT iE		09 10	3014	3041	•
	400	MP3 LT iE (Parking Brake)		09 10		3191	
	400	MP3LT Touring		11 12	3014	3041	•
	400	MP3 LT Touring (Parking Brake)		11 12		3191	
	400	MP3 Touring		11 12	3014	3041	•
	400	MP3 Touring (Parking Brake)		11 12		3191	
	400	X8 Left/Rear		07	3041	3041	
	400	X8 Right		07	3097		







400	Xevo Left/Rear	08		3041	3041	
400	Xevo Right	08		3097		
500	Beverly Cruiser	08		3035	3035	•
500	MP3	10		3014	3041	•
500	MP3 (Parking Brake)	10			3191	
500	MP3 LT Touring Business	11	13	3014	3041	•
500	MP3 LT Touring Business (Parking Brake)	11	13		3191	
500	MP3 LT Touring Business ABS	14		3028	3041	•
500	MP3 LT Touring Business ABS (Parking Brake)	14			3191	
500	MP3 LT Touring Sport	11	13	3014	3041	•
500	MP3 LT Touring Sport (Parking Brake)	11	13		3191	
500	MP3 LT Touring Sport ABS	14		3028	3041	•
500	MP3 LT Touring Sport ABS (Parking Brake)	14			3191	
500	MP3 Touring Business	11	12	3014	3041	•
500	MP3 Touring Business (Parking Brake)	11	12		3191	
500	MP3 Touring Sport	11	12	3014	3041	•
500	MP3 Touring Sport (Parking Brake)	11	12		3191	
500	X10 Executive Left/Rear	13		3041	3097	
500	X10 Executive Right	13		3097		
500	X10 Executive (Parking Brake)	13			3191	
500	X9	01	03	3035	3035	•
500	X9 Evolution	04		3027	3035	•
500	X9 Evolution ABS	04		3027	3035	

**PIAGGIO COMMERCIAL VEHICLE**

500	QUARGO			3177		
1000	PORTER (CARBURATORE)	92	94	3177		
1000	PORTER (INEIZIONE)	95	98	3177		
1200	PORTER (DISEL)	95	00	3177		
1300	PORTER 16V 4X4	98	07	3177		
1300	PORTER 16V GPL	98	07	3177		
1300	PORTER 16V MAXX	98	07	3177		
1300	PORTER 16V PIC UP	98	07	3177		
1300	PORTER 16V VAN	98	07	3177		
1300	PORTER MAXX UP DATE	09		3177		
1300	PORTE UP DATE	09		3177		
1400	PORTER DIESEL	95	00	3177		

**POLARIS**

	Trail Blazer	90	93	4157		•
	Trail Boss 2x4	85	87	01205		
	Trail Boss 2x4, 4x4	88	89	4157		•
200	Phoenix	05	09	3074	3095	•
200	Phoenix	10			3095	•
200	Sawtooth	06		3074	3074	•
250	2x4, 4x4	90	93	4157		•
250	Big Boss 4x6, 6x6	89	93	4157		•
250	Cyclone	87		01205		
250	Trail Blazer	94	98	4157		•
250	Trail Blazer	99		4157		•
250	Trail Boss	88	90	4158		•
250	Trail Boss	91	99	4157		•
250	Trail Boss 2x4, 4x4	91	92	4157		•
250	Xplorer 4x4	00		4157		•
300	2x4, 4x4	94	95	4157		•
300	Big Boss 6x6	94		4157		•
300	Xpress L	96	97	4157		•

								
325	Magnum 2x4, 4x4				00 02	4157		•
325	Trail Boss				00 02	4157		•
325	Xpedition				00 01	4158		•
325	Xpedition				02	4158		•
330	ATP				04 05	4157	4157	•
330	ATP				06	4157		•
330	E Trail Blazer				08	4158		•
330	Magnum 2x4, 4x4				03	4157		•
330	Trail Boss				03	4157		•
335	Sportsman 4x4				99	4157		•
350	Big Boss				93	4157		•
350	L 2x4, 4x4				90	4157		•
350	L 4x4				93	4157		•
350	Trail Boss L 4x4				91	4157		•
400	Big Boss L 6x6				96	4157		•
400	L 2x4				94 95	4157		•
400	L 4x4				94	4157		•
400	Scrambler 2x4, 4x4				00	4157		•
400	Scrambler 4x4				98	4157		•
400	Scrambler 4x4				99	4157		•
400	Scrambler L 4x4				95 97	4157		•
400	Sport				99 00	4157		•
400	Sport L				94 98	4157		•
400	Sportsman				01	4157		•
400	Sportsman L 4x4				94 97	4157		•
400	Trail Blazer				03	4157		•
400	Xplorer L 4x4				95 99	4157		•
400	Xplorer L 4x4				00	4157		•
400	Xpress L				96 97	4157		•
425	2x4, 4x4 Magnum				95 98	4157		•
425	Magnum 6x6				96	4157		•
425	Xpedition 4x4				00	4157		•
450	Outlaw MXR				09		4158	•
450	Outlaw S				08		4158	•
450	Sportsman				06	4157		•
455	Diesel EBS 4x4				99	4157		•
500	ATP HO				04	4157	4157	•
500	Big Boss 6x6				98 99	4157		•
500	E Scrambler 2x4, 4x4				08	4158		•
500	Magnum 2x4, 4x4				02	4157		•
500	Magnum 4x4				00 01	4157		•
500	Outlaw				06	4157	4157	•
500	Predator				03	4157	4157	•
500	Predator e				06	4157		•
500	Ranger 6x6				00 02	4157		•
500	Revolver				06	4158	4158	•
500	Scrambler 2x4				01	4157		•
500	Scrambler 4x4				97	4157		•
500	Scrambler 4x4				98	4157		•
500	Sportsman 4x4				96	4157		•
500	Sportsman 6x6				00	4157		•
500	Sportsman EBS 4x4				98	4157		•
500	Sportsman HO (from 16.12.2008)				09 -	4158		•
500	Sportsman HO (to 15.12.2008)				03 08	4158		•
500	Xplorer 4x4				97	4157		•
525	Outlaw				07		4158	•
525	Outlaw IRS				08		4158	•



525	Outlaw S		08		4158	•
570	Ranger RZREFi		12		4158	•
600	Sportsman		03		4158	•
700	Sportsman		02		4158	•
700	Sportsman MV 700		05		4158	•
800	Ranger RZREFi		08		4158	•
800	Ranger RZRSEFi		09		4158	•
800	RZR		08		4158	•
800	Sportsman (from 16.12.2008)		09		4158	•
800	Sportsman (to 15.12.2008)		05	08	4158	•

**POLINI**

Cross 50	50		99		3033	3033
X1	50	R	04		3032	3032
X3	50	R	04		3032	3032
X5	65	RP	05		3032	3032

**PRAGA**

ED	250		99		3027	3088
CD	610		99		3027	3088

**PROTOS**

	50	Elisse Scooter car	98		3010	
--	----	--------------------	----	--	------	--

**PUCH**

		Condor	90		3015	
	50	Cobra 6 GT, GTL	80			01241
	50	Maxi 30 all models (excl. Spain)			01241	01241
	50	Maxi 40 all models			01241	01241
	50	Monza 4 GP, all models			01241	01241
	50	Monza 4 SL			01241	01241
	50	Monza 4 SL, GSL	80			01241
	50	Storm (Austria)			3010	0266
	50	Typhoon (Austria)		95	3010	0266
	50	Typhoon (Austria)	96			0275
TZX	50		92		3015	
	75	Cobra	85		3015	
MAXI	80		88			3029

**QUADRO**

	350	3	16		3016	3074	•
	350	4	16		3016	3074	•
D	350		11	15	3010	3074	•

**QUINGOI**

QM	125	2V	02		3019	
QM	125	GY	02		3070	

**REWACO**

		FX4	07		3029	
		FX5	07		3029	
		FX6	07		3029	
		HS4	01		3029	
		HS5	01		3029	
		HS6	01		3029	
		RF1	07		3029	



## RIEJU

		AJP Caliper incl. pin/spring		3015	
	50	Drac	97	3015	3015
	50	Drag	92	3013	
	50	FD4 Super Marathon	85	3015	
	50	First, H2O	97	3015	
	50	Racing Spec. Edition	01	3055	3015
	50	Spike Racing	02	3015	3015
	50	Spike Racing	02	3055	3015
	50	Spike X	08	3187	3187
	50	Tango	08	3035	3015
	50	Tango	10	3035	3015
	50	Windy	97	3015	
MRT	50		09	3187	3187
MRT	50	Pro	09	3035	3035
MRT	50	Pro Supemotard	09	3035	3035
MRT	50	Supemotard	09	3187	3187
MRX	50	Racing	02	3015	3015
MRX	50	Pro	05	3055	3015
NKD	50		04 07	3043	3015
RR	50	Supemotard	96	3015	3015
RRX	50		08	3187	3187
RRX	50		08	3015	3015
RRX	50	Spike	08	3015	3015
RS1	50	Castrol	01	3017	3015
RS1	50		92	3013	3015
RS1	50	Evolution	96 00	3015	3015
RS2	50	Matrix	03	3043	3048
RS2	50	NKD	06	3147	3074
RS3	50		12	3043	3074
RS3	50	Pro	12	3142	3015
RV	50			3015	
SMX	50		02	3015	3015
SMX	50		02	3055	3015
SMX	50	Pro	08	3035	3015
	75	K6, IC Strada	87	3015	
	75	P6, IC Strada	87	3015	
MR	80	C.E	88	3015	
MR	80	Cross	87	3015	
MR	80	Enduro	87	3015	
RST	80		91	3015	3015
	125	Marathon Pro	09	3035	3187
	125	Marathon Pro Supemotard	09	3035	3187
	125	Tango	06	3142	3015
	125	Tango	08	3035	3015
	125	Tango Pro	08	3035	3015
MRX	125		03	3015	3015
MRX	125		03	3055	3015
RR	125		97	3015	3015
RS2	125	NKD	06	3147	3074
RS2	125	Pro	08	3149	3074
RS3	125		10	3142	3015
SMX	125		03	3015	3015
SMX	125		03	3055	3015
	250	Tango	08	3035	3015
MRX	250	Marathon	10	3027	3056
MRX	450	Marathon	08	3027	3056



**ROXON**

	50	Duel SM		06		3015	3015
	50	Duel TT		06		3015	3015
	150	Quad Sport Spirit		06			3074

**ROYAL ENFIELD**

	535	Continental GT		14		3090	3088
--	-----	----------------	--	----	--	------	------

**SACHS**

	50	MadAss		04		3069	
	50	MadAss 4T		05		3069	3083
SW	80	Lotus				3029	•
	125	MadAss		09		3069	3083
	125	Roadster V2		01		3026	
	125	X-Road		05		3030	
XTC	125			99		3030	
XTC-N	125			99		3030	
ZX	125			99		3026	
ZZ	125			99		3026	
	500	MadAss		05		3030	•
	650	Roadster V1.6		01		3030	
	800	B-805		02		3030	•
	800	Roadster V2		00		3030	•
	800	S-805		03		3030	•

**SANGLAS**

	400	Y		79	80	3029	3029	•
	500	S2		79	80	3029	3029	•

**SCORPA**

SY	115	F Trial		06		3040	3042
TY-S	115	F Trial		06		3015	3042
	125	Twenty Trial		16		3040	3042
SY	125	F Trial		06		3040	3042
TY-S	125	F Trial		06		3015	3042
	250	T-Ride		08		4162	3048
	250	Twenty Trial		16		3040	3042
SY	250	F Trial		06		3040	3042
SY	250	Trial		00		3040	3042
	300	Twenty Trial		16		3040	3042

**SHE-LUNG**

	50	Falcon		97		3076	
	50	Racer		96		3011	
	125	Mars		97		3076	

**SHERCO**

		AJP Caliper incl. pin/spring				3015	
	50	Supermotard, Enduro		02	06	3055	3015
SE	50	Enduro		07		3017	3048
SM	50	Supermotard		07		3017	3048
	80	0.8		01		3015	3015
ST	80	(Formula cal.)		13	14	4161	3042
	125			02		3077	3015
	125	City Corp 4T Enduro		03		3077	3015
	125	City Corp 4T SM		03		3077	3015
SE	125	1.25F		10		3017	3048



SE-R	125		17		3027	3056
ST	125	(Formula cal.)	13	14	4161	3042
ST	125	1,25	01	05	3015	3015
ST	125	1,25	06		3040	3042
ST	200	2,0	01		3015	3015
SE	250	R	14		3027	3056
SE	250	2.5i Enduro	06	11	3027	3101
SE	250	F, F-R	14		3027	3056
SE	250	i/iR	12	13	3027	3056
SE	250	i-F	13		3027	3056
ST	250	(Formula cal.)	13	14	4161	3042
ST	250		99	00	3015	3015
ST	250	2,5	01		3040	3042
SX	250	2.5i-F	09	11	3027	3101
ST	290	(Formula cal.)	13	14	4161	3042
ST	290	2,9	01		3040	3042
SCF-R	300		16		3027	3056
SE	300	R	14		3027	3056
SE	300	3.0i-F	10	11	3027	3101
SE	300	F, F-R	14		3027	3056
SE	300	i/iR	12	13	3027	3056
SE	300	i-F	13		3027	3056
ST	300		16		3040	3042
ST	305	(Formula cal.)	13	14	4161	3042
ST	320	3,2F	05		3040	3042
SE	450	4.5i Enduro	04		3027	3087
SE	450	4.5i Enduro	05	11	3027	3101
SE	450	F, F-R	14		3027	3056
SE	450	iR	12	13	3027	3056
SM	450	4.5i Supermotard	06		3107	3101
SE	510	5.1i Enduro	06	11	3027	3101
SE	510	iR	12	13	3027	3056

**SIAM**

	50	Falcon	97		3010	
	50	Mat	97		3075	
	50	Scross	97		3010	
	100	Mat	97		3075	

**SIAMOTO**

	50	Birdie	02		3076	
	125	BD, KD	02		3055	

**SIMSON**

	50	Habict CX	01		3029	
	50	Spatz	99		3029	
	50	Sperber	99		3029	
	50	Star	99		3029	
	80	IFA	89		3029	
SR	80	2 CE			3029	
S	83	CX			3029	
S	83	OR			3029	
	125		01		3026	
	125	RS	01		3026	
	125	Schikra	99		3026	3029
	125	SM	01		3055	3015
	125	Star	99		3015	

**SMC**

	50	Easy Rider	97	3075	01205
--	----	------------	----	------	-------

**SULA**

	50	City Bird	99	3076	01205
	50	Thunder Bird	99	3074	01205
	100	Thunder Bird	99	3074	01205
	125	Thunder Bird	99	3074	01205

**SUZUKI**

		AJP Caliper incl. pin/spring		3015	
	50	Wolf	89	3095	
AE	50	R/L	88	3074	
AH	50	Adress	92	95	3074
AJ	50	Sepia	92	3075	
AP	50		95	3011	
AY	50	Katana	96	3015	
AY	50	Katana	96	3011	
AY	50	W	00	3010	3015
AY	50	WR	00	3010	3015
CC	50	Tune	92	3074	
CP	50		85	3074	
CR	50	DC	87	3074	
DR	50	Big	89	3015	
GSR	50		87	3095	
OR	50	E	80	3095	
RB	50		87	3095	
RG	50	GAG	87	3095	
RG	50	Gamma	90	3095	
RME	50		10		3046
RMX	50		00	3015	3015
SMX	50	Super Motard	00	3015	3015
TR	50	Street Magic	97		0310
TV	50	Wolf	89	3095	
UF	50	Estilete	00	3015	
UX	50	W Zillion	99	3015	
ZR	50		81	87	3095
ZZ	50	Scooter	92	3074	
RM	65		03	06	3083
LIDO	75	Style		3074	
AH	80	Adress, V, Tune	88	3074	
AH	80	Scooter	92	3075	
GT	80	L/C	81	3095	
RG	80		85	3134	
RG	80	Gamma		87	3095
RG	80	Gamma	88	93	3134
RM	80		86	89	3075
RM	80		90	95	3075
RM	80		96	01	3074
ZZ	80	Sepia	90	3074	
RM	85	L	02	04	3074
AH	100	V Adress	91	94	3074
RM	100		03		3106
UG	110	Hokuto	00		0310
UK	110	Adress	15		3074
TRS	118		82	83	3095
AN	125		06	08	3074

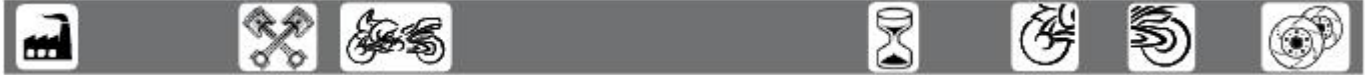

DR	125		86	02	3083	
DR	125	SM	08		3050	3087
EN	125		05		3063	
GN	125		82	90	3187	
GN	125		91	04	3095	
GN	125		05		3187	
GS	125	E, Katana	90	94	3187	
GS	125	ESD	83	94	3187	
GS	125	ESZ	82		3095	
GT	125		80		3095	
GX	125	R	88		3083	
LIDO	125	Vario Scooter	90		3074	
RG	125	F, Gamma	92	96	3062	
RG	125	Gamma	85	90	3134	
RG	125	Wolf	92	94		3052
RH	125	X	87		3083	
RM	125		87		3063	
RM	125		88		3063	3106
RM	125		89	90	3063	3086
RM	125		91	95	3063	3086
RM	125		96	09	3050	3087
RV	125	VanVan	03		3091	
SP	125		86	88	3083	
SX	125		85		3083	
TR	125		83		3095	
TS	125		85	89	3083	
TS	125		89	96	3063	3086
TU	125	XT	99		3095	
UE	125		01		3074	
UH	125	Burgman	02	06	3027	3035
UH	125	Burgman	07	16	3081	3108
UX	125	SIXteen	08		3081	3108
X4	125	X3E			3095	
UE	150	CT	02		3074	
UH	150	Burgman	04	06	3027	3035
UX	150	SIXteen	08		3081	3108
DR	200		86	88	3083	
DR	200	S	15		3083	
DR	200	SE	96	13	3083	
DR	200	T	96		3083	
RG	200	Gamma	91		3062	
RV	200	VanVan	16		3091	
SP	200		86	88	3083	
SX	200	R	85		3083	
TS	200	R	90	94	3063	3086
UH	200		07		3081	
UH	200	Burgman	07	13	3081	3108
UH	200	Burgman	14		3064	3108
LT	230		85	88		3106
LT	230		86	93		3106
ET	240		86		3095	
RH	240	X	87		3083	
TS	240	X	85		3083	
	250	Across	90			3052
	250	Bandit	90	96		3052
	250	Cobra	90		3062	3052
	250	Djebel	93			3086











	250	Impulse	95		3059					.
	250	Sky Wave Type II	98		3018	3034				.
	250	Wolf	90		3062	3052				
AN	250	Burgman	98	03	3018	3034				
AN	250	Burgman	04	06	3018	3047				
DL	250	V-Strom	17		3059	3072				
DR	250		85	89	3083					
DR	250		90	95	3063	3086				
DR-Z	250		01		3050	3086				
GF	250		88			3052				.
GSF	250	V5, S Bandit	95		3092					
GSX	250	S, Katana	91			3052				
GSX-R	250		88	89		3052				.
GSX-R	250		17		3059	3072				
GSX-R	250	R	89		3062	3052				.
GW	250	Inazuma	12		3059	3072				
GW	250	Inazuma F	15		3059	3072				
LT-F	250	Ozark	03		3083					.
LT-Z	250	Quad Sport	04		3083					.
NZ	250		86		3095					
RG	250		83	84	3052	3052				
RG	250	Gamma	84	88		3052				.
RGV	250		88		3127	3052				.
RGV	250		89	90	3062	3052				.
RGV	250		93	95	3062					.
RGV	250	Gamma	91	92	3062					.
RH	250		85		3083					
RM-Z	250		04	06	3050	3101				
RM-Z	250		07	09	3050	3101				
RM-Z	250	Efi	10		3050	3101				
SP	250		85		3083					
TS	250	X	85	89	3083					
TU	250	X	09		3092					
TV	250		88		3062	3052				
LT-F	300	King Quad Left/Rear	02		3063					
LT-F	300	King Quad Right	02		3064					
DR	350		90	99	3063	3086				
DR	350	V, W, X	97		3050	3086				
AN	400	Burgman	99	00	3018	3034				
AN	400	Burgman	01	06	3018	3047				
AN	400	Burgman Left/Rear	07	16	3063	3104				
AN	400	Burgman Right	07	16	3064					
AN	400	Burgman Left/Rear	17		3063	3104				
AN	400	Burgman Right	17		3064					
DR-Z	400	S / E	00		3050	3087				
DR-Z	400	SM	05	10	3050	3087				
GSF	400	Bandit	91	92		3052				.
GSF	400	Bandit	93	97	3062	3052				.
GSX	400	EFX	82		3095					
GSX	400	F	89			3052				.
GSX	400	FD	83		3095					
GSX	400	FWS	83		3052	3052				.
GSX	400	FX, FZ	81	82	3095					
GSX	400	Impulse	94	96	3059	3052				.
GSX	400	S, Katana	83		3095					
GSX	400	S, Katana	92		3062	3052				.
GSX	400	X	86			3052				.



GSX-R	400			87			3052	•	
GSX-R	400			88	89	3062	3052	•	
GSX-R	400	F		85	86		3052	•	
GSX-R	400	R		90	95	3127	3052	•	
KLT-A	400	King Quad	Left	08			3109		
KLT-A	400	King Quad	Right	08			3111		
KLT-F	400	King Quad	Left	08			3109		
KLT-F	400	King Quad	Right	08			3111		
LT-A	400	Eiger	2WD/4WD	02	07	3083		•	
LT-A	400	King Quad	Left	08			3109		
LT-A	400	King Quad	Right	08			3111		
LT-F	400	Eiger	2WD/4WD	02			3083	•	
LT-F	400	King Quad	Left	08			3109		
LT-F	400	King Quad	Right	08			3111		
LT-Z	400	QuadSport		02			3106	3037	•
RF	400	RVC		93	97		3059	3052	
GS	450			86			3095		•
LT-A	450	King Quad	Left	08			3109		
LT-A	450	King Quad	Right	08			3111		
LT-R	450	Left/Rear		06			3063	3037	
LT-R	450	Right		06			3064		
RMX	450	Z Ffi		10			3050	3101	
RMX	450	Z Ffi		17			3050	3101	
RM-Z	450			05	07		3050	3101	
RM-Z	450	Ffi		08			3050	3101	
GS	500			89	95			3052	
GS	500			96	03	3091		3052	
GS	500			04		3091		3052	
GS	500	F		04		3091		3052	
GSX	500			83			3052	3052	•
LT	500			87	95			3037	•
LT-A	500	F Vinson		02			3083		•
LT-A	500	FY Quadmaster	Left	00			3063		
LT-A	500	FY Quadmaster	Right	00			3064		
LT-A	500	King Quad	Left	11			3109		
LT-A	500	King Quad	Right	11			3111		
LT-F	500	F Left		98			3064		
LT-F	500	F Right		98			3063		
RG	500			85	87			3052	•
RG	500	Gamma		85				3052	•
RM	500			87			3063	3106	
GS	550			83			3052	3052	
GSX	550			83	87		3052	3052	•
GSF	600	Bandit		95	99		3059	3052	•
GSF	600	Bandit / S Bandit							
		Left/Rear		00	04		3092	3052	
GSF	600	Bandit / S Bandit	Right	00	04		3091		
GSR	600			06	10		3062	3131	•
GSX	600	FW Left		98			3092	3052	
GSX	600	FW Right		98			3091		
GSX	600	Katana		88	89			3052	•
GSX	600	Katana		90	97			3052	•
GSX-R	600	(Rad.cal)		04	05		3117	3137	•
GSX-R	600	(Rad.cal)		06	10		3117	3131	•
GSX-R	600	(Rad.cal)		11			4113	4114	•
GSX-R	600			92	93		3127	3052	•
GSX-R	600			97	00		3062	3052	•

								
GSX-R	600				01 03	3062	3052	•
RF	600	R			93 96	3059	3052	•
AN	650	A Burgman Executive			04 12	3059	3104	•
AN	650	Burgman			02	3059	3104	•
AN	650	Z Burgman Executive			13	3059	3104	•
DL	650	V-Strom Left/Rear			04 13	3092	3072	
DL	650	V-Strom Right			04 13	3091		
DL	650	V-Strom Left/Rear			17	3092	3072	
DL	650	V-Strom Right			17	3091		
DL	650	V-Strom XT Left/Rear			15 16	3092	3072	
DL	650	V-Strom XT Right			15 16	3091		
DL	650	V-Strom XT Left/Rear			17	3092	3072	
DL	650	V-Strom XT Right			17	3091		
DR	650	SE T-W			96	3050	3086	
GSF	650	Bandit			07	3062	3072	•
GSF	650	Bandit / S Bandit Left/Rear			05	3092	3137	
GSF	650	Bandit / S Bandit Left/Rear ABS			06	3092	3072	
GSF	650	Bandit / S Bandit Right			05	3091		
GSF	650	Bandit / S Bandit Right ABS			06	3091		
GSF	650	Bandit ABS			07 12	3062	3072	•
GSF	650	S Bandit			07	3062	3072	•
GSF	650	S Bandit ABS			07 13	3062	3072	•
GSX	650	F			08 13	3062	3072	•
SFV	650	Gladius Left/Rear			09	3092	3155	
SFV	650	Gladius Right			09	3091		
SV	650	S Left/Rear			99 02	3092	3052	
SV	650	S Right			99 02	3091		
SV	650	S Left/Rear			03 12	3092	3072	
SV	650	S Right			03 12	3091		
SV	650	Left/Rear			16	3092	3155	
SV	650	Right			16	3091		
XF	650	Freewind			97 02	3091	3073	
LT-A	700	King Quad Left			05	3109		
LT-A	700	King Quad Right			05	3111		
GS	750	Katana			85	3052	3052	•
GS	750	RF			85		3052	•
GSR	750	Left/Rear			11	3092	3072	
GSR	750	Right			11	3091		
GSX	750	ES			84 85	3052	3052	•
GSX	750	FW Left/Rear			98 02	3092	3052	
GSX	750	FW Right			98 02	3091		
GSX	750	Left/Rear			98 08	3092	3052	
GSX	750	Right			98 08	3091		
GSX-R	750	(Rad.cal)			04 05	3117	3137	•
GSX-R	750	(Rad.cal)			06 10	3117	3131	•
GSX-R	750	(Rad.cal)			11	4113	4114	•
GSX-R	750				85 87		3052	•
GSX-R	750				88 93	3127	3052	•
GSX-R	750				94 99	3060	3052	•
GSX-R	750	Y			00 03	3062	3052	•
GSX-S	750				17	4120	3072	•
GSX-S	750	Left/Rear			15 16	3092	3072	
GSX-S	750	Right			15 16	3091		
GSX-S	750	Z Left/Rear			15 16	3092	3072	
GSX-S	750	Z Right			15 16	3091		
LT-A	750	King Quad Left			08	3109		
LT-A	750	King Quad Right			08	3111		



C	800	Intruder	05		3091	
DR	800	S, Big	91	95		3064
DR	800	ST Big	96		3092	3064
DR-Z	800		88	90		3106
M	800	Intruder	05		3091	
VL	800	Intruder LC Volusia	01	04	3091	
VZ	800	Marauder	97	04	3091	
RF	900	RR,RS,RS2,T,V	94	97	3127	•
DL	1000	V-Strom	14	16	3117	3131 •
DL	1000	V-Strom	17		3117	3131 •
DL	1000	V-Strom Left/Rear	02	13	3092	3072
DL	1000	V-Strom Right	02	13	3091	
DL	1000	V-Strom XT	17		3117	3131 •
GSX-R	1000	(Rad.cal)	03		4119	3137 •
GSX-R	1000	(Rad.cal)	04	06	3117	3137 •
GSX-R	1000	(Rad.cal)	07	08	3117	3131 •
GSX-R	1000	(Rad.cal)	09	11	3117	4114 •
GSX-R	1000	(Rad.cal)	12	16	4113	4114 •
GSX-R	1000	(Rad.cal)	17		4113	4114 •
GSX-R	1000		01	02	3060	3137 •
GSX-R	1000	R (Rad.cal)	17		4113	4114 •
GSX-S	1000		15		4113	3072 •
GSX-S	1000	F	15		4113	3072 •
SV	1000	S	03	07	3062	3072 •
TL	1000	RW	98	02	3060	3052 •
TL	1000	SV-Twin	97	01	3062	3052 •
GSX	1100		86		3052	3052 •
GSX	1100	F	93	96		3052 •
GSX	1100	G Left/Rear	96		3092	3052
GSX	1100	G Right	96		3091	
GSX	1100	Katana	93		3127	3052 •
GSX-R	1100		89	92	3127	3052 •
GSX-R	1100		93	97	3060	3052 •
GSF	1200	Bandit	95	96	3127	3052 •
GSF	1200	Bandit	97	00	3127	3052 •
GSF	1200	Bandit	01	05	3060	3052 •
GSF	1200	Bandit	06		3062	3072 •
GSF	1200	S Bandit	01	05	3060	3052 •
GSF	1200	S Bandit	06		3062	3072 •
GSX	1200		99	01	3093	3052 •
GSF	1250	A Bandit	07		3062	3072 •
GSF	1250	Bandit	06		3062	3072 •
GSF	1250	F Bandit	12		3062	3072 •
GSF	1250	S Bandit	06		3062	3072 •
GSF	1250	SA Bandit	07		3062	3072 •
GSX	1250	FA Bandit	16		3062	3072 •
GSX	1250	FA Traveller	15		3062	3072 •
	1300	B-King	07		4115	3072 •
GSX-R	1300	Hayabusa	99	07	3060	3052 •
GSX-R	1300	Hayabusa	08	12	3117	3131 •
GSX-R	1300	Hayabusa (Rad.cal)	13		4113	3131 •
	1340	B-King	08		4120	3131 •
GSX	1400		02	07	3060	3137 •
C	1500	Intruder Left/Rear	05	10	3092	3062
C	1500	Intruder Right	05	10	3091	
C	1500	T Intruder	13		3059	3091
M	1500	Intruder Left/Rear	09		3092	3091 •









M	1500	Intruder Right	09	3091		•
VL	1500	Intruder LC Left/Rear	02	3092	3062	
VL	1500	Intruder LC Right	02	3091		
M	1600	Intruder	05	4119	3091	•
VZ	1600	Marauder	04	3060	3091	•
C	1800	R Intruder	08	3081	3091	•
M	1800	R Intruder	06	3117	3091	•
M	1800	R2 Intruder	08	3117	3091	•
M	1800	RBZ Intruder	16	3117	3091	•

**SWM**

	125	GP	86	3029	3029	•
	125	S1-S2		3029		
	250	Explorer	86	3029	3029	
	250	Pioner	86	3029	3029	
	250	S1-S2		3029		
RS	300	R	15	3027	3056	
TRL	329	MJ	86	3029		
XP	350	Sahara		3141		
	440	Gran Milano	15	3059		
	440	Gran Turismo	15	3059		
	440	Silver Vase	15	3059		
SM	450	R	15	3107	3056	
RS	500	R	15	3027	3056	
	650	Superdual	15	3107	3088	

**SYM**

	50	Allo	11	3099		
	50	Bullet	93	3183		
	50	Cinderella	01	3183		
	50	Crox	14	3099		
	50	Feel-big	98	3183		
	50	Fiddle	09	3099		
	50	Fiddle III	16	3099		
	50	Jet 4 Naked	11	3099		
	50	Jet 4 R	11	3099		
	50	Jet BasiX	07	3099		
	50	Jet Euro X	05	3099		
	50	Jet Sport X	06	3099		
	50	Jet Sport X SR	06	3099		
	50	Jet, Alpha	95	3099		
	50	Jungle	96	3099		
	50	Mask	00	3099		
	50	Mask LC	00	3099		
	50	Mio	05	3183		
	50	Orbit II	12	3099		
	50	Pure	98	3183		
	50	Red Devil	97	3099		
	50	Super Fancy	95 97	3099		
	50	Super Fancy	98	3132		
	50	Symphony	09	3099		
	50	Symphony SR	11	3099		
	50	Symphony ST	15	3099		
	50	Symply	08	3099		
	50	XPro	14	3099		
DD	50		02	3183		
RS	50		05	3149		

															
RS21	50							02							3149
	100	Cinderella						01							3183
	100	Jet						00							3099
	100	Jet Euro X						05							3099
	100	Jet Sport X						05							3099
	100	Mio						05							3183
	100	Party						97							3099
	100	Super Fancy						95							3099
	110	Bullet						93							3186
	110	Star						03							3099
	125	Aero Wolf													3186
	125	Allo						11							3099
	125	Attila						95							3099
	125	Citycom						09							3099
	125	Crox						14							3099
	125	Euro MX						03							3149
	125	Fiddle						09							3099
	125	Fiddle III						16							3099
	125	GTS						07							3018
	125	Husky						96	98						3095 0310
	125	Jet 14						17							3099 3014
	125	Jet 4						11							3099
	125	Joymax Sport						16							3018 3100
	125	Joyride						01	06						3149 3049
	125	Joyride						07	09						3149 3100
	125	Joyride Evo						10							3149 3100
	125	Joyride S						16							3149 3100
	125	Megalo						02							3099
	125	New Duke						02	07						3099
	125	Super Duke						95	01						3099 0310
	125	Symphony						09							3099
	125	Symphony EX						17							3099
	125	Symphony S						11							3099 3014
	125	Symphony SR						11							3099 3014
	125	Symphony ST						15							3099 3014
	125	Symply						08							3099
	125	Voyager						05							3037
	125	Wolf Classic						05							3069
	125	Wolf Legend						02							3069
	125	XPro						14							3099
HD	125							04							3049
HD	125	Evo DT						10							3099 3100
HD2	125	Evo						14							3099 3100
RS	125							05							3149 3021
RS21	125	R						02							3149
SB	125	Wolf Ni						11							3100 3133
VS	125							07							3149
VS	125							09							3149
	150	Attila						00							3099
	150	Crox						14							3099
	150	Euro MX						03							3149
	150	Husky						99							0310
	150	Jet 4						11							3099
	150	Joyride						01							3149 3049
	150	Super Duke						96	01						3099
	150	Symphony S						11							3099 3014
	150	Symphony SR						11							3099 3014



H01	150		95	3099	
RS	150		05	3149	3021
VS	150		07	3149	
MF	180		03	3069	
	200	Fiddle II	11	3099	
	200	Fiddle III	16	3099	3014
	200	Joyride	01	3149	3049
	200	Joyride Evo	09	3099	
	200	Joyride S	16	3149	3100
	200	Quadlander	12	3133	3100 •
	200	Trackrunner	05 08	3133	3100 •
HD	200		04	3049	
HD	200	Evo	07	3099	3100
HD2	200	Evo	14	3099	3100
	250	GTS	07	3018	3100
	250	Joymax	07	3037	3100
	250	Joymax Sport	16	3018	3100
	250	Quadlander	06 07	3133	3100 •
	250	Voyager	05	3037	
RV	250	Efi	10	3018	3100
SN	250	Ni Wolf	14	3174	3133
SN	250	T2 Wolf	12	3174	
	300	City Max	06 07	3133	3100 •
	300	Citycom	09	3099	3099
	300	Citycom S	15	3099	3099
	300	Cruisym	17	3174	3100
	300	Joymax Evo	10	3018	3100
	300	Joymax Sport	16	3018	3100
	300	Joyride Evo i	10	3018	3100
	300	Quadlander	06	3133	3133 •
	300	Wolf Cafe Racer	15	3174	3133
	300	Wolf Classic	15	3174	3133
GTS	300		09	3018	3100
GTS	300	Evo i	11	3018	3100
SB	300	Cafe Racer	16	3174	3133
	400	iMaxsym	11	3098	3188 •
	400	iMaxsym	12	3174	3188 •
	500	GT	07	3018	3049
	600	iMaxsym	14	3174	3188 •
	600	Quad Raider	08	3133	3133 •

**TGB**

		309 Racing	05	3074	
		309 RS	00	3074	
		507	05	3074	
		Buffalo	03		3021
		Double X	05	3074	
		J409	00	3074	
	50	101R	05 09	3074	
	50	101S	99	3074	
	50	202T	99	3074	0310
	50	203	05	3070	
	50	303R	99	3074	
	50	Akros	99	3074	
	50	Akros tec 5	99 04	3070	
	50	Apollo	99	3070	



	50	Bull&t RS/RR	11		3187	3074
	50	Bullet	09		3074	3074
	50	Bullet	10		3187	
	50	Bunny	97		3074	
	50	Corona	03		3013	
	50	Ergon	96		3074	
	50	Fire, Sky	03		3070	
	50	Hawk	09		3074	
	50	Hiw's	99		3074	
	50	Hook	10		3074	
	50	Tapo RS	11		3074	
	50	Trigger	99	03	3074	
R	50	X	06		3013	3074
	90	101S	99		3074	
	90	202T	99		3074	
	90	Akros	99		3074	
	90	Apollo	99		3070	
	90	Ergon	99		3074	
	90	Hiw's	99		3074	
	90	Trigger	99		3074	
	125	101S	99		3074	
	125	202T	99		3074	
	125	303R	99		3074	
	125	Bull&t RS/RR	11		3187	3074
	125	Hook	10		3074	
	125	X-Large	11			3100
	125	X-Motion	08			3100
	250	Dynasty	06		3070	3076
	250	X-Motion	08			3100
	300	X-Motion	10			3100

**TM**

	80	Cross	96	00	3027	3088
	80	Junior	96	00	3074	3106
	85		01	12	3027	3087
	85		13		3046	3046
	125		96	00	3027	3088
	125		01	04	3027	3087
	125		05		3027	3101
	125	Enduro	01	04	3027	3087
	125	Enduro	05		3027	3101
SMR	125		05		3030	3087
	250		01	04	3027	3087
	250		05		3027	3101
	250	E	95	00	3027	3088
	250	Enduro	01	04	3027	3087
	250	Enduro	05		3027	3101
	250	F	01	04	3027	3087
	250	F	05		3027	3101
	250	F Enduro	00		3027	3088
	250	F Enduro	01	04	3027	3087
	250	F Enduro	05		3027	3101
	300		98	00	3027	3088
	300		01	04	3027	3087
	300		05		3027	3101
	300	Enduro	01	04	3027	3087
	300	Enduro	05		3027	3101





	320			96	97	3027	3088
	400	F		00		3027	3088
	400	F		01		3027	3087
	400	F Enduro		01		3027	3087
SMF	400	F		02		3030	3087
SMR	400	F		03		3030	3087
	450	F		02	04	3027	3087
	450	F		05		3027	3101
	450	F Enduro		02	04	3027	3087
	450	F Enduro		05		3027	3101
FT	450	Fi		17		3027	3101
SMR	450	F		04		3030	3087
SMX	450	F		03		3030	3087
SMX	450	F		04		3107	3087
	530	F		01	04	3027	3087
	530	F		05		3027	3101
	530	F Enduro		01	04	3027	3087
	530	F Enduro		05		3027	3101
SMR	530	F		03		3030	3087
SMX	600	F		03		3030	3087
SMX	660	F		04		3107	3087

**TOMOS**

		Revival		02		3010	
		Streetmate		03		3010	
	50	Hip Hop		06		3015	
	50	Racing		06		3015	
	50	Street Soul		06		3015	
	50	Youngstr		06		3015	
BT	50	S		89		3013	
MC	50	Senior Pro		04		3011	3011
N	50	AT, BT		91		3013	
SE	50			05		3055	3015
CTX	80			89		3013	
MC	125	T		06		3077	3015
SE	125			05		3077	3015
SM	125	F (Rad.cal)		06		3142	3015

**TORNAX**

RX	80					3029	
----	----	--	--	--	--	------	--

**TRIUMPH**

	600	Daytona		03	04	3127	3073	•
	600	Speed Four		03	06	3127	3073	•
TT	600			00	03	3127	3073	•
	650	Daytona		05	06	3127	3073	•
	675	Daytona (Rad.cal)		06	08	4120	3073	•
	675	Daytona R Triple (Rad.cal)		11	12	4113	3073	•
	675	Daytona R Triple (Rad.cal)		13		4113	3088	•
	675	Daytona Triple (Rad.cal)		09	12		3073	•
	675	Daytona Triple (Rad.cal)		13			3088	•
	675	Street Triple		08	12	3059	3073	•
	675	Street Triple		13		3059	3088	•
	675	Street Triple R		09	12	4120	3073	•
	675	Street Triple R		13		4120	3088	•
	675	Street Triple RX		15		4120	3088	•
	750	Bonneville U.K.		87		3141	3141	•



	750	Daytona	91	92	3127	3064	•
	750	Trident Left/Rear	91		3063	3063	
	750	Trident Right	91		3064		
	800	America	03	06	3059	3063	
	800	Bonneville	01	04	3059	3063	
	800	Bonneville America	02		3059	3063	
	800	Bonneville T100 Centennial Edition	02	04	3059	3063	
	800	Bonneville T100 Paul Smith	06	08	3059	3063	
	800	Speedmaster	03	04	3059	3063	•
	800	Tiger	11	14	3059	3073	•
	800	Tiger XC	11		3059	3073	•
	800	Tiger XC ABS	12	14	3059	3073	•
	800	Tiger XCA	15		3059	3073	•
	800	Tiger XCR	15		3059	3073	•
	800	Tiger XR	15		3059	3073	•
	800	Tiger XRT	15		3059	3073	•
	800	Tiger XRX	15		3059	3073	•
	900	Adventurer	96		3059	3071	
	900	America	07		3059	3063	
	900	Bonneville	05	08	3059	3064	
	900	Bonneville	09		3059	3063	
	900	Bonneville Newchurch	15		3059	3063	
	900	Bonneville SE	09	13	3059	3063	
	900	Bonneville Spirit	15		3059	3063	
	900	Bonneville Street Cup	17		3059	3063	
	900	Bonneville T100	05	08	3059	3063	
	900	Bonneville T100	09	16	3059	3063	
	900	Bonneville T100	17		3059	3063	
	900	Bonneville T100 Black	17		3059	3063	
	900	Bonneville T214	15		3059	3063	
	900	Daytona	91	94	3127	3064	•
	900	Daytona Super III	94			3064	•
	900	Daytona, Sprint	94		3127	3064	•
	900	Daytona, Sprint Left/Rear	93		3063	3063	
	900	Daytona, Sprint Right	93		3064		
	900	Legend TT	99		3059	3071	
	900	Scrambler	06	16	3059	3063	
	900	Speed Triple	94	96	3127	3064	•
	900	Speedmaster	05		3059	3063	•
	900	Street Scrambler	17		3059	3063	
	900	Street Twin	16		3059	3063	
	900	Thrupton	04		3059	3063	
	900	Thrupton Ace	15		3059	3063	
	900	Thunderbird	96		3059	3071	
	900	Thunderbird Sport	03		3059	3071	•
	900	Tiger	99	00	3059	3071	•
	900	Tiger Left/Rear	93	98	3063	3063	
	900	Tiger Right	93	98	3064		
	900	Trident Left/Rear	91		3063	3063	
	900	Trident Right	91		3064		
	900	Trophy	96		3127	3064	•
	900	Trophy Left/Rear	91	95	3063	3063	
	900	Trophy Right	91	95	3064		
T509	900	Speed Triple	97	01	3127	3063	•
T595	950	Daytona	96	98	3127	3063	•
	955	Daytona Centennial	02		3127	3063	•
	955	Daytona from VIN 132513	99		3127	3073	•



955	Daytona to VIN 132512	99		3127	3063	•
955	Speed Triple	99		3127	3063	•
955	Sprint RS	00		3127	3063	•
955	Sprint ST	99	04	3127	3063	•
955	Tiger	01	04	3059	3059	•
955	Tiger	04	06	3059	3064	•
1000	Daytona	92		3127	3064	•
1000	Trophy Left/Rear	91	95	3063	3063	
1000	Trophy Right	91	95	3064		
1050	Speed 94	15		3107	3063	•
1050	Speed 94R	15		4113	3063	•
1050	Speed Triple	16		4113	3063	•
1050	Speed Triple (Rad.cal)	05	07	4120	3063	•
1050	Speed Triple (Rad.cal)	08	15	3107	3063	•
1050	Speed Triple R	12	15	4113	3063	•
1050	Speed Triple R	16		4113	3063	•
1050	Speed Triple S	16		4113	3063	•
1050	Sprint GT ABS	11		3127	3063	•
1050	Sprint ST	05	11	3127	3063	•
1050	Tiger	07		4120	3064	•
1050	Tiger SE (Rad.cal)	09		4120	3064	•
1050	Tiger Sport	15		4120	3063	•
1200	Bonneville Bobber	17		3059	3063	
1200	Bonneville T120	16		3059	3063	
1200	Bonneville T120 Black	16		3059	3063	
1200	Daytona	91		3127	3064	•
1200	Thrupton	16		3059	3063	•
1200	Thrupton R	16		4113	3063	•
1200	Tiger Explorer	12		3127	3063	•
1200	Trophy	96	03	3127	3064	•
1200	Trophy Left/Rear	91	95	3063	3063	
1200	Trophy Right	91	95	3064		
1200	Trophy SE	13		3018	3063	•
1600	Thunderbird	09		3127	3090	•
1700	Thunderbird Commander	14		3127	3090	•
1700	Thunderbird LT	14		3127	3090	•
1700	Thunderbird Storm	11		3127	3090	•
2300	Rocket III	04		3127	3090	•
2300	Rocket III Classic	07		3127	3090	•
2300	Rocket III Roadster	10		3127	3090	•
2300	Rocket III Touring	13		3127	3090	•
2300	Rocket X	15		3127	3090	•

**TRS**

250	ONE	16		3040	3042	
280	ONE	16		3040	3042	
300	ONE	16		3040	3042	

**UVM**

50	BeThere	99		3074		
50	Bingo	99		3074		
125	BeThere	99		3074		
125	Bingo	99		3074		
125	Paragon	99		3074		

**VERTEMATI**

C	500	Cross	02	04	3027	3088	
---	-----	-------	----	----	------	------	--



E	501	Enduro	02	04	3027	3088
S	501	Supemotard	02	04	3027	3088

**VERTIGO**

	300	Combat Camo Works	15			3042
	300	Combat Ice Hell	15			3042
	300	Combat RR	15			3042

**VICTORY**

		Empulse TT	16		3093	3035	•
	1200	Octane	17		3090	3088	
	1500	Kingpin	04	05	3093	3090	
	1500	Touring Cruiser	03	06	3093	3090	•
	1500	V92C Cruiser	98	02	3093	3090	
	1500	V92C Deluxe	01	02	3093	3090	
	1500	V92SC Sport Cruiser	00	02	3093	3090	•
	1500	Vegas	03	05	3093	3090	
	1500	Vegas 8-Ball	05		3093	3090	
	1634	Hammer	05	07	3093	3090	
	1634	Hammer	08		4120	3071	•
	1634	Hammer S	06	08	3093	3090	
	1634	Kingpin	06	07	3093	3090	
	1634	Kingpin all models	08		4120	3071	
	1634	Kingpin Tour	06	07	3093	3090	
	1634	Vegas	06	07	3093	3090	
	1634	Vegas	08		4120	3071	
	1634	Vegas 8-Ball	06	07	3093	3090	
	1634	Vegas 8-Ball	08		4120	3071	
	1634	Vegas Jackpot	06	07	3093	3090	
	1634	Vegas Jackpot	08		4120	3071	
	1731	Boardwalk	13		4120	3071	
	1731	Cross Country	10		4120	3071	•
	1731	Cross Country 8-Ball	14		4120	3071	•
	1731	Cross Country Tour	12		4120	3071	•
	1731	Cross Roads	10		4120		•
	1731	Cross Roads 8-Ball	14		4120		•
	1731	Cross Roads Classic	14		4120		•
	1731	Gunner	15		4120		
	1731	Hammer	09		4120		•
	1731	Hammer 8-Ball	10		4120		•
	1731	Hammer S	09		4120		•
	1731	Hard-Ball	12		4120		•
	1731	High-Ball	12		4120		
	1731	Jackpot	10		4120		
	1731	Judge	13		4120		
	1731	Kingpin	10		4120		
	1731	Kingpin 8-Ball	10		4120		
	1731	Magnum	15		4120		•
	1731	Magnum X-1	15		4120		•
	1731	Vegas	10		4120		
	1731	Vegas 8-Ball	10		4120		
	1731	Vegas Jackpot	09		4120		
	1731	Vision all models	08		3189		•

**VOR**

	400	Cross	00	01	3027	3088
	400	Enduro	00	01	3027	3088



EN	400			02		3027	3088
MX	400			02		3027	3088
SM	400			02		3030	3088
EN	450			02		3027	3088
MX	450			02		3027	3088
SM	450			02		3030	3088
	500	492 Enduro		99		3027	3088
	500	492 Super Motard		00	01	3030	3088
	500	495 Cross		99		3027	3088
EN	530			02		3027	3088
MX	530			02		3027	3088
SM	530			02		3030	3088

**VOXAN**

	1000	Cafe Racer		01	06	3030	3035	•
	1000	Roadster		01	06	3030	3035	•
	1000	Scrambler		01	03	3059	3064	•
VB1	1000	EVO		04		3093	3035	•

**WRM**

	450	MX		06		3027	3056
--	-----	----	--	----	--	------	------

**XINGFU**

XF	150	A		97		3185
----	-----	---	--	----	--	------

**YAMAHA**

		AJP Caliper incl. pin/spring				3015	
	50	Axis Pro Foot		92		3076	
	50	Beluga		90		0304	0304
	50	Cygnus		96		3085	
	50	Jog R/RR		02	14	3010	
	50	Neo's 4		09		3010	
	50	Slider		00	05	3016	
	50	Why		99		3010	0304
BW	50			91	94	0304	0304
BW	50	Bump		97		3010	0304
BW	50	Next Generation		96	07	3010	0304
BW	50	Sports Spec R		02		3010	
BW	50	Spy		95		3010	0304
CR	50	Target		91		3076	01205
CR	50	Z		91	95	3076	0304
CW	50	TA Zuma		90		0304	0304
CX	50			88		01205	01205
CY	50	F Jog		94			01205
DT	50	LCD		98			01205
DT	50	MX		87	90	0304	0304
DT	50	R		89	95	3085	0304
DT	50	R		96	97	3085	0304
DT	50	R		98	03	3012	01205
DT	50	R		04		3015	3048
DT	50	X Supermotard		04		3017	3048
FZR	50			90		3064	
FZR	50			92		3063	3086
IOG	50	(Spain)		88		3076	
IOG	50	CY		90	92		0304
IOG	50	R				3076	0304
IOG-Z	50			88	89	3076	



JOG-Z	50		90		3011	
NS	50	Aerox	13		3011	3016
RS	50	Champ	88		3076	
T	50		86		0304	0304
TDR	50		90		3085	3085
TRAFIC	50	M	83		0304	0304
TZM	50	R	94		3064	3085
TZR	50		90	92	3064	3085
TZR	50		93	02	3064	3148
TZR	50		03		3017	3015
V	50	M	83		0304	0304
YA	50	Axis Mofa	97		3010	0304
YE	50	Zest (Italy)	92	95	3011	01205
YE	50	Zest (Japan)	92	95	3076	
YFM	50	Raptor	04		01205	
YH	50		98		3011	
YM	50	Breeze, Fizz	95		3011	0304
YN	50	Neo's, LC	97		3010	0304
YQ	50	Aerox	97	12	3011	3016
YSR	50		87	91	3085	01205
YSR	50		92		3085	
YF	60	S Moto 4	86			0304
YT	60	Tri Zinger	84	85		0304
	80	Beluga		89	01205	01205
CH	80	Beluga (CH 80)	90		0304	
CV	80	Riva	83	87	01205	01205
CW	80	Beluga	81	83	01205	01205
DT	80	LC-2	85	92	3085	
DT	80	MX, MXS	84	85	0304	0304
PW	80		83	85		0304
PW	80		91			01205
RD	80	LC	83		3085	
T	80	Townmate	83	97	0304	0304
TDR	80		89		3085	3085
TY	80		83			01205
TZR	80		92		3076	3085
V	80	DL	83		0304	0304
YD	80		89		3063	3086
YE	80	Zest (Italy)	93		3011	
YE	80	Zest (Japan)	93		3076	
YFM	80		87	88	0304	
YFM	80	Badger	95		01205	
YFM	80	Grizzly	05		01205	
YFM	80	Raptor	02		01205	
YSR	80		86		3085	01205
YZ	80		93	01		3106
YZ	85	LW	02			3106
	90	Axis Pro Foot	94		3076	
CR	90	Target	91		3076	01205
JOG	90		90		3076	
TT-R	90		00			01205
YA	90	Axis	90		3076	
YFM	90	RY Raptor	09		01205	3095
	100	Aerox	00	06	3010	
	100	Neo's	00	02	3010	
AG	100	Fambike	92	93	0304	
FJ	100	L, LC	84		3053	3053

















RS	100	DX	77	79		01205
RS	100	DX	80	82		01205
RT	100	A-H	90	96	01205	01205
RXS	100		83	97	0304	0304
YB	100		82	86		01205
YB	100		87	92	01205	01205
YW	100	Booster	99	02	3076	
YZ	100		82	83	01205	
	105	Crypton	98		3085	0304
TT-R	110		08			01205
	115	D'elight	14		3152	
	125	Tricity Left/Rear	14		3178	
	125	Tricity Right	14		3179	
	125	N-Max	15		3182	3152
	125	Xenter	12		3146	
BWs	125		10		3146	
DT	125	LC	85	87	3085	
DT	125	R	96	07	3085	3085
DT	125	R, Electric	88	03	3085	3085
DT	125	X Supermotard	05		3090	3086
MT	125		14		3098	3133
NXC	125	Cygnus	10		3153	
NXC	125	Cygnus X	05	09	3077	
SR	125		92	96		0304
SR	125		97	02	3019	0304
SR	125	Flame	96		3085	
SR	125	SE	82			01205
SX	125	R	88		3083	
TDR	125	R	93	03	3019	3085
TT-R	125		00		01205	01205
TT-R	125	LW	00			01205
TW	125		99		3022	01205
TZ	125		97		3127	
TZR	125		89	92	3053	
TZR	125		93		3019	3053
TZR	125		94		3094	3053
TZR	125	R	94		3094	
VP	125	X-City	08		3071	3035
WR	125		91	97	3063	3086
WR	125		98		3050	3087
WR	125	R, XY	09		3059	3088
XC	125	Cygnus F	00		3085	
XC	125	F	00		3085	
XC	125	TR Cygnus, R	96		3085	
XC	125	Vity	08		3152	
XN	125	Teos	01		3010	
XO	125	Maxter	01		3027	3035
XT	125		82			01205
XT	125	R	05		3048	3015
XT	125	X Supermotard	05		3017	3015
XTZ	125		05		3063	
XV	125	Virago	97	00	3019	
XVS	125	Drag Star	00		3019	
Y	125	Fair Breeze	92		0304	
YBR	125		06	07	3085	
YBR	125		08		3152	
YFA	125	1 G-M Breeze	95		01205	

















YFM	125	Grizzly	04		01205	
YP	125	Majesty	01		3027	3035
YP	125	R Majesty	99	00	3027	
YP	125	X-Max	06	09	3080	3035
YP	125	X-Max	10		3071	3035
YP	125	X-Max ABS	11		3071	3022
YP	125	X-Max Business ABS	11		3071	3022
YP	125	X-Max Sport Ed.	11		3071	3035
YT	125	Tri Moto	80	81		
YW	125	Z	10		3146	
YZ	125		88			3085
YZ	125		89		3063	3106
YZ	125		90	95	3063	3086
YZ	125		96	97	3063	3086
YZ	125		98		3050	3087
YZ	125		03	07	3050	3101
YZ	125		08		3105	3101
YZF	125	R	08	13	3027	3133
YZF	125	R	14		3098	3133
	135	Crypton X	08		3152	
	150	N-Max	15		3182	3152
	150	Teos	02		3010	
	150	Xenter	12		3146	
FZH	150	Fazer	11		3027	
XC	150	Fly One	92		3085	
XC	150	Fly One R	98		3085	01205
XQ	150	Maxter	01		3027	3035
YP	150	Majesty	01		3027	3035
YZF	150	R15	14		3152	
DT	175		00		3022	
YT	175	Tri Moto	82	83	01205	
RT	180		95	96	3085	
YP	180	R Majesty	03		3027	
YP	180	R Majesty	04		3027	3035
SR	185	Exiter, H, I	81	82		01205
BW	200		85	88	01205	01205
DT	200		89		3085	3085
DT	200	WR	91	93	3063	3086
IT	200		85		3085	
SX	200	R	88		3083	
TT	200		86		3085	01205
TW	200		87	00		01205
TW	200		01		3022	01205
WR	200		91	92	3063	3086
XT	200		85			01205
YFM	200	DXS-DXW Moto 4	86	87	01205	
YFM	200	N Moto 4	85	89	01205	
YFS	200	R Blaster	03	06	3083	3106
YFS	200	U-P Blaster	88	02	01205	
YTM	200	K-N Tri Moto	83	85	01205	
	225	Bronco, Cellow	97		3022	
	225	Serow	85		3085	
TT	225	S,T	86	00	3085	01205
TTR	225		01		3085	01205
XT	225		92	00	3085	01205
XT	225		01		3022	01205
XT	225	Serow	86		3085	01205









								
YFM	225	Moto 4			86	88	01205	
YTM	225	DRN, DRS Tri Moto			85	86	01205	
YTM	225	DXK, DXN Tri Moto			83	85	01205	
TT-R	230				05		3063	
FZ	250	Phazer N,S			85	86	3053	•
FZR	250				87	88	4135	•
FZX	250	Zeal			91	92	3057	
IT	250				85		3085	
MT-25	250				16		4175	
RD	250	LC			83			3053
SRV	250				92	97	3057	
TDR	250				88	92	4135	
TT	250				93	03	3063	3086
TY	250	R			91	92	3015	
TY	250	Z			93	96	3015	3015
TY	250	Z (Scottish)			96		3085	3086
TZ	250	(Rad.cal)			02		3127	•
TZ	250				90	01	3127	•
TZR	250				87	88	4135	•
TZR	250				89	92	3094	•
TZR	250	R			94		3030	•
VP	250	X-City			07		3071	3022
WR	250				90	97	3063	3086
WR	250				98	02	3050	3087
WR	250	F			01	02	3050	3087
WR	250	F			03	13	3050	3101
WR	250	F Ffi			15		3050	3101
WR	250	R			08		3050	3101
WR	250	X			08		3059	3101
XG	250	Tricker			05		3022	3086
XT	250				08		3022	3086
XV	250	S Virago			95	07	3019	
XVS	250	Drag Star			01		3019	
YBR	250				07		3064	
YD	250	S			90		3053	
YFM	250	AN Bruin 2x4			05		3083	•
YFM	250	Bear Tracker			01		3083	•
YFM	250	Raptor Left/Rear			09			3106
YP	250	D Majesty DX			98		3019	3022
YP	250	Majesty			96		3019	
YP	250	Majesty DX/ABS			99	14	3019	3022
YP	250	X-Max			05	09	3080	3022
YP	250	X-Max			10	13	3071	3022
YP	250	X-Max			14		3071	3150
YTZ	250	Tri Moto			85	86	3085	3085
YZ	250				88			3085
YZ	250				89		3063	3106
YZ	250				98	02	3050	3087
YZ	250				03	07	3050	3101
YZ	250				08		3105	3101
YZ	250	A			90		3063	3086
YZ	250	B1-J1			91	97	3063	3086
YZ	250	F			01	02	3050	3087
YZ	250	F			03	06	3050	3101
YZ	250	F			07	13	3105	3101
YZ	250	F Ffi			14	15	3105	3101
YZ	250	F Ffi			16		3105	3101

									
YZ	250	FX Efi			15		3105	3101	
YZ	250	WRA,WRB			90	91	3063	3086	
YZF	250	R25			15		4175		
VP	300	Versity			03	04	3027	3027	
VP	300	Versity			05	06	3071	3027	
YFM	300	Warrior			89		3083	3106	
MT-03	321				16		4175		
YZF	321	R3			15		4175		
RD	350	LC YPVS			83	84		3053	•
RZ	350				84	85		3053	•
TT	350				95		3063	3086	
XT	350				85	96	3085		
YFM	350	Bruin 2x4, 4x4			04		3083		•
YFM	350	ERT, ERU			87	88	01205		
YFM	350	FWBL, LC Big Bear			99		3083		•
YFM	350	EXG-FXM Wolverine			95		3083	3106	•
YFM	350	R Raptor			04		3106	3106	•
YFM	350	XG,XH Warrior			95	96	3083	3106	•
YFM	350	XT,XU Warrior			87	88	3085	3106	•
YFM	350	XW,XA-MW Warrior			89		3083	3083	•
YFZ	350	Banshee			87	89	3085	3106	•
YFZ	350	Banshee			90	06	3083	3106	•
YZ	360				89		3063	3106	
	400	Artesia			91		3148	3085	
FZ	400	N			87		3053		•
FZR	400				87		3053		•
FZR	400				88	90	4135		•
FZR	400	A			90		4138		
FZR	400	R			91		3094		•
SR	400				14		3019		
SRX	400				85	86	4138		
SRX	400				87		4135		
WR	400	F			98		3050	3086	
WR	400	F			99	00	3050	3087	
XJ	400	Diversion			91		3057		
XJR	400	R			95		3093	3053	
XS	400	Z			83		3053	3053	
XT	400				86		3085		
YFM	400	FAM Kodiak			00		3083	3108	•
YFM	400	FARK Kodiak Automatic			03		3083		•
YFM	400	FWN Big Bear 4WD			00		3083	3108	•
		Bear-Buckmaster 4WD			00		3083	3108	•
YFM	400	N Big Bear 2WD			00		3083	3108	•
YP	400	Majesty			04		3057	3078	
YP	400	Majesty			05		3019	3078	•
YP	400	R X-Max			13		3071	3102	
YP	400	RA X-Max			14		3071	3102	
YZ	400				98		3050	3086	
YZ	400	F			99		3050	3087	
WR	426	F			01	02	3050	3087	
YZ	426	F			00	02	3050	3087	
WR	450	F			03	15	3050	3101	
WR	450	F Efi			16		3105	3101	
YFM	450	FA Kodiak			03		3083	3108	•
YFM	450	Wolverine			06		3083	3108	•
YFZ	450	S Left/Rear			04	05	3064	3106	
YFZ	450	S Right			04	05	3063		

									
YFZ	450	S Left/Rear			06	09	3064	3034	
YFZ	450	S Right			06	09	3063		
YXR	450	Rhino Left/Rear			06		3063	3144	
YXR	450	Rhino Right			06		3064		
YZ	450	F			03	07	3050	3101	
YZ	450	F			08	09	3105	3101	
YZ	450	F Efi			10	13	3105	3101	
YZ	450	F Efi			14	15	3105	3101	
YZ	450	F Efi			16		3105	3101	
YZ	450	FX Efi			16		3105	3101	
FZR	500	(Austria)			89		3053	3053	•
FZR	500	R (Austria)			90	91		3053	•
RD	500				83		3053	3053	•
RD	500	LC			84	86	3053		•
RZ	500				84	86	3053		•
WR	500	B			91		3063	3085	
WR	500	ZD,ZE			92	93	3063	3086	
XP	500	TMAX			01	03	3057	3058	
XP	500	TMAX			04	07	3019	3078	•
XP	500	TMAX			08	11	3094	3078	•
XP	500	TMAXTechMax			11		3094	3078	•
XT	500				86		3085		
XT	500	E (Austria)			90	96	3148	3085	
XP	530	TMAX			12		3094	3058	•
XP	530	TMAX DX			17		3094	3058	•
XP	530	TMAXIronMax			15		3094	3058	•
XP	530	TMAX SX			17		3094	3058	•
XV	535	DX Virago			98	03	3057		
XV	535	S Virago			96	03	3057		
DT	600	N			85		3085		
FJ	600				84		3053	3053	•
FZ	600				86	87	3053	3053	•
FZ	600	S,SC			86		3053		•
FZ6	600				04		3019	3072	•
FZ6	600	Fazer			04		3019	3072	•
FZ6	600	Fazer S2			07		3094	3072	•
FZ6	600	Fazer S2 ABS			07		3094	3072	•
FZ6	600	S2			07		3094	3072	•
FZ6	600	S2 ABS			07		3094	3072	•
FZ6R	600				09		3019	3073	•
FZR	600				89		3053	3053	•
FZR	600	R			90	91		3053	•
FZR	600	R			92	95		3053	•
FZS	600	Fazer			98	03	3094		•
FZS	600	S Fazer			01	03	3094		•
SRX	600				88	89	4135		
SRX	600				90		4138		
TT	600				85	88	3085		
TT	600	ES			96	01	3027	3088	
TT	600	R			93	95	3027	3086	
TT	600	R			98	07	3027	3088	
XJ	600				83	91	3053	3053	•
XJ	600	N			91	97	3057		
XJ	600	N			98		3019		•
XJ	600	S Diversion			91	97	3057		•
XJ	600	S Diversion			98	03	3019		•
XJ6	600	Diversion			09		3019	3073	•

								
XJ6-F	600				09 12	3019	3073	•
XJ6-F	600				13	3019	3072	•
XJ6-N	600				09 12	3019	3073	•
XJ6-N	600				13	3019	3072	•
XJ6-S	600				09 12	3019	3073	•
XJ6-S	600				13	3019	3072	•
XT	600	E			90	3148	3085	
XT	600	K			91	3148	3085	
XT	600	Z Tenere			87 90		3085	
YFM	600	4x4 Grizzly			98 01	3106		•
YX	600	Radian			87 90	3053		•
YZF	600	R Thunder Cat			96 03	3094	3053	•
YZF	600	R6			99 02	3094	3022	•
YZF	600	R6			03 04	3094	3072	•
YZF	600	R6 (Rad.cal)			05 16	3094	3072	•
YZF	600	R6 (Rad.cal)			17	3094	4114	•
XVS	650	A Drag Star Classic			98 06	3057		
XVS	650	Drag Star			97 06	3057		
	660	Rhino Left/Rear			05	3063	3144	
	660	Rhino Right			05	3064		
MT-03	660				06 13	3019	3088	•
SZR	660				96 01	3030	3029	
XT	660	R			04 11	3090	3088	
XT	660	X			04 13	3093	3088	
XT	660	Z Tenere			08 14	3027	3088	•
XT	660	Z Tenere ABS			11 14	3027	3088	•
XTZ	660	Tenere			91 98	3148	3085	
YFM	660	FWAP4x4 Grizzly			02	3106		•
YFM	660	RN Raptor			01	3106	3106	•
FZ	700				87	3053	3053	•
FZX	700	Fazer			87	3053	3053	
MT-07	700				14	3094	3072	•
MT-07	700	Moto Cage			15	3094	3072	•
MT-07	700	Tracer			16	3094	3072	•
XJ	700				86	3053		
XJ	700	Maxim			85	3053	3053	
XSR	700				16	3094	3072	•
XV	700	L LC			84	3053		•
XV	700	Virago			87	3053		
YFM	700	R Raptor Left/Rear			06 08	3063	3144	
YFM	700	R Raptor Right			06 08	3064		
YFM	700	Raptor			09 12	3063	3144	
YFM	700	Raptor			09 12	3064		
YFM	700	Raptor			13	3063	3034	
YFM	700	Raptor			13	3064		
YXR	700	Rhino Left			08	3064	3064	
YXR	700	Rhino Right			08	3063	3063	
	750	Maxim			81		3053	
FZ	750				85 86	3053	3053	•
FZ	750	Genesis			86	3053		•
FZ	750	Genesis			87 88	3053	3053	•
FZ	750	Genesis			89 92	4135	3053	•
FZR	750	R			89 92	3127	3053	•
FZR	750	R Genesis			87 88	4138	3053	•
FZX	750	Fazer			86 90	3053	3053	•
TX	750	A			73 76		3053	•
VF	750	Virago			88	3053		

									
XJ	750				83	84	3053	3053	•
XTZ	750	Super Tenere Left/Rear			89	95	3063	3064	
XTZ	750	Super Tenere Right			89	95	3064		
XV	750				89	92	3053		
XV	750	Virago			94	97	3057		•
YZF	750	R, SP			93	97		3053	•
YZF	750	R7OW02			99	02	3094		•
	800	Fazer 8			10		3094	3072	•
FZ8	800				10	14	3094	3072	•
TDM	850				91	95	4135	3053	•
TDM	850				96	01		3053	•
TRX	850	(Italy)			95		3093	3053	•
TRX	850				95	00	4138	3053	•
MT-09	900	(Rad.cal)			14		3094	3072	•
MT-09	900	Sport Tracker (Rad.cal)			15		3094	3072	•
MT-09	900	Street Rally (Rad.cal)			14		3094	3072	•
MT-09	900	Tracer (Rad.cal)			15		3094	3072	•
TDM	900				02	14	3094	3139	•
XJ	900				83		3053	3053	•
XJ	900	F			85	93	3053	3053	•
XJ	900	S, Diversion			94	03	3057	3053	•
XSR	900				16		3094	3072	•
XV	920	Virago			81			3053	•
SCR	950	Scrambler			17		3057	3139	
XV	950	Bolt			14		3057	3139	
XV	950	Bolt C-Spec			15		3057	3139	
XV	950	Bolt R-Spec			14		3057	3139	
XVS	950	A Midnight Star			09		3057	3139	
FZ1	1000	Fazer			06		3094	3072	•
FZR	1000				94	95		3053	•
FZR	1000	EXUP			90	91		3053	•
FZR	1000	EXUP			92	93		3053	•
FZR	1000	Genesis			87	89	4138	3053	•
FZS	1000	Fazer			01	05	3094		•
GTS	1000				93	99		3053	
MT-10	1000				16		3094	3072	•
MT-10	1000	SP			17		3094	3072	•
XV	1000	L, C			84		3053	3053	•
XV	1000	Virago			86		3053		•
YZF	1000	R Thunder Ace			96	99	3094	3053	•
YZF	1000	R1			98	01	3094		•
YZF	1000	R1			02	03	3094	3022	•
YZF	1000	R1 (Rad.cal)			04	06	3094	3072	•
YZF	1000	R1 (Rad.cal)			15		3094	4114	•
YZF	1000	R1 (Rad.cal)(4-pad)			07	14	4118	3072	•
YZF	1000	R1 (Rad.cal)(4-pad) ABS			12	14	4118	3072	•
YZF	1000	R1 SP (Rad.cal)			06		3094	3072	•
YZF	1000	R1M (Rad.cal)			15		3094	4114	•
YZF	1000	R1S (Rad.cal)			16		3094	4114	•
BT	1100	Bulldog			02	06	3094	3053	•
FJ	1100				83	85	3053	3053	•
XV	1100	Virago			86	93	3053		•
XV	1100	Virago			94	98	3057		•
XV	1100	Virago			99		3019	3053	•
XVS	1100	Drag Star			99	06	3019	3053	•
XVS	1100	Drag Star Classic			00	06	3019	3053	•
FJ	1200				86	87	3053	3053	•



FJ	1200		88	90	4138	3053	•
FJ	1200	ABS	91	93	4138	3053	•
V-MAX	1200		85	89	3053	3053	•
V-MAX	1200		90	92	3053	3053	•
V-MAX	1200		93	03		3053	•
XJR	1200	(Italy)	95	98	3093	3053	•
XJR	1200		94	98	4138	3053	•
XJR	1200	SP	97	98	4138	3053	•
XTZ	1200	Super Tenere	10		3094	3139	•
XTZ	1200	Super Tenere ZE	14		3094	3139	•
XV	1200		84		3053	3053	•
XV	1200	Venture Royale	85		3053	3053	•
XV	1200	Z1ZT	84		3053	3053	•
XVT	1200	T, Vent. Royale	84		3053	3053	•
FJR	1300		01	03	3094	3139	•
FJR	1300	A	13	15	3018	3139	•
FJR	1300	A	16		3018	3139	•
FJR	1300	ABS	03	05	3094	3139	•
FJR	1300	ABS	06	12	3018	3139	•
FJR	1300	AE	16		3018	3139	•
FJR	1300	AS	13	15	3018	3139	•
FJR	1300	AS	16		3018	3139	•
XJR	1300		99	01	3094	3053	•
XJR	1300		02		3094		•
XJR	1300	Racer	15		3094		•
XJR	1300	SP	01		3094	3053	•
XVS	1300	A Midnight Star	07	11	3019	3139	•
XVS	1300	Custom	14		3019	3139	•
XVS	1300	Stryker	11		3057	3139	•
XVZ	1300	A Royal Star	96	07	4138	4135	•
XVZ	1300	AT Royal Star Tour Classic	97	07	4138	4135	•
XVZ	1300	Royal Star Boulevard	99		4138	4135	•
XVZ	1300	TF Royal Star Venture	99		3057	4135	•
XVZ	1300	Venture Royale	86	89	4138	4135	•
XVZ	1300	Venture Royale	90	95	4138	4135	•
XV	1600	A Wild Star	99	07	3057	4135	•
MT-01	1700	(Rad.cal)	05	06	3094	3071	•
MT-01	1700	(Rad.cal)	07		4118	3071	•
VMX	1700	V-Max	09		4118	3139	•
XV	1700	PC RoadStar Warrior	03	07	3094	3139	•
XV	1700	RoadStar Warrior	02		3094	4135	•
XV	1900	A	11		3018	3139	•
XV	1900	A Midnight Star	06	10	3094	3139	•

**ZANELLA**

	50	Racing Moped	92	-		3029	
RZA	125		92	-		3029	

**ZERO**

DS	ZF11.4		13		3050	3101	
DS	ZF11.4		14		3050	3088	
DS	ZF12.5		15		3090	3088	
DS	ZF13.0		16		3090	3088	
DS	ZF6.0		10	12	3099	3074	
DS	ZF8.5		13		3050	3101	
DS	ZF8.5		14		3050	3088	
DS	ZF9.0		10	12	3099	3074	



DS	ZF9.4	15	3090	3088
DS	ZF9.8	16	3090	3088
DSR	ZF13.0	16	3090	3088
EX	ZF2.8	13	3050	3101
EX	ZF2.8	14	3050	3088
EX	ZF2.8	15	3027	3088
EX	ZF3.3	16	3090	3088
EX	ZF5.7	13	3050	3101
EX	ZF5.7	14	3050	3088
EX	ZF5.7	15	3027	3088
EX	ZF6.5	16	3090	3088
EXS	ZF3.3	16	3090	3088
EXS	ZF6.5	16	3090	3088
MX		10 12	3099	3074
MX	ZF2.8	13	3050	3101
MX	ZF5.7	13	3050	3101
S	ZF11.4	13	3050	3101
S	ZF11.4	14	3050	3088
S	ZF12.5	15	3090	3088
S	ZF13.0	16	3090	3088
S	ZF6.0	10 12	3099	3074
S	ZF8.5	13	3050	3101
S	ZF8.5	14	3050	3088
S	ZF9.4	15	3090	3088
S	ZF9.8	16	3090	3088
SR	ZF11.4	14	3050	3088
SR	ZF12.5	15	3090	3088
SR	ZF13.0	16	3090	3088
X		10 12	3099	3074
XU		11 12	3099	3074
XU	ZF2.8	13	3050	3101
XU	ZF5.7	13	3050	3101

**ZUNDAPP**

KS	175	78	3141	
----	-----	----	------	--

# Brake Pads

## Code Key

organic brake pads  3...

sintered brake pads  4...

ceramic brake pads  5 = = =

off road brake pads  6...



# Brake Pads

3010 ORGANIC  
4010 SINTERED

A 49,7 | L 39,8 | S 6,5

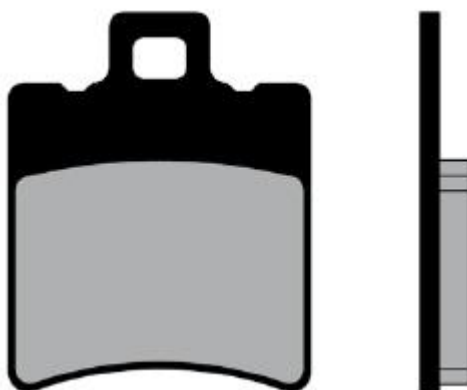













## APRILIA







	50	Amico, Scooter	92	•	
	50	Amico, GL, GLE	93-	•	
	50	Area 51	99-	•	•
	50	Business	97-	•	
	50	Compay	09- 13	•	
	50	Classic	96-	•	
	50	Club	97-	•	
	50	Gulliver	96- 00	•	
	50	Habana/Custom	99- 02	•	
	50	McGulliver	00-	•	
	50	Mojito Retro	99- 03	•	
	50	Mojito, Mojito Custom	99- 12	•	
	50	Scarabeo Ditech	02-	•	
	50	Scarabeo Street	00-	•	
	50	Scarabeo, 2nd series	94- 99	•	
	50	Sonic, GP	99-	•	
	50	Younger	97-	•	
	50	Rally	95-	•	
AC	50	Rally	95- 02	•	
LC	50	Rally	96- 01	•	•
SR	50	Ditech	01- 06	•	
SR	50	Racing	00-	•	
SR	50	Replica (Liquid Cooled)	96-	•	
SR	50	Stealth, Racing	97-	•	•
SR	50	Street	05- 12	•	
	125	Leonardo	96	•	
	125	Leonardo	97- 98		•
	150	Leonardo	97- 98		•

## ATALA

	25	Carosello	97-	•	
--	----	-----------	-----	---	--

					
50	Carosello	97-	•		
50	Hacker	95-	•		
125	Hacker	98-	•		
<b>BENELLI</b>					
50	Chrono	94-	•		
50	Nemo,Quadra	94-	•		
50	Pepe	99-	•		
491	GT,Sport	98-	•		
491	Naked	99-	•		
50	Naked	02-	•		
491	Racing	99-	•	•	
491	RR,-GP	00-	•	•	
491	ST	01-	•		
491	Superbike	99-	•	•	
K2	Air	98-	•	•	
K2	LC	99-	•	•	
K2	Namur	99-	•	•	
100	Naked	02-	•		
K2	Biposto	99-	•		
LX	Pepe	02-	•		
125	Adiva	00-	•		
125	Velvet, Velvet Touring	99-	•		
666	Born in Hell	98-			•
150	Adiva	00-	•		
150	Velvet, Velvet Touring	00-	•		
250	Velvet, Velvet Touring	99-	•		
400	Velvet Dusk	03-			•
<b>BERINGER</b>					
6 Piston Caliper					
<b>BETA</b>					
50	Ark AirCooled	99-	•		
50	Ark K Series	97-	•	•	
50	Ark LC	99-	•	•	
50	Chrono 13	94- 99	•		
50	Eikon	04-	•		
50	Quadra	95- 96	•		
50	Tempo	99	•		
50	Tempo (13" wheels)	00-	•		
50	Tempo (16" wheels)	00-	•		
125	Eikon	04-	•		
150	Eikon	04-	•		
<b>CPI</b>					
50	GTR	03-			•
125	GIRGIS	02-			•
200	GIRGIS	02-			•
<b>DERBI</b>					
50	Vamos R 50 Vamos R (Brembo cal.)	95-	•		
<b>GARELLI</b>					
50	Flo'	00-	•		
125	Panther	02-			•
150	Panther	02-			•
250	Panther	02-			•
<b>GENERIC</b>					
50	Toxic	07-			•
50	Trigger SM	06-			•
50	Trigger SM Competition	08-			•
50	Trigger X	06-			•
50	Trigger X Competition	08-			•
<b>GILERA</b>					

						
	50	DNA		01-		•
	50	Eaglet		97-	•	
	50	Ice		02-	•	
	50	Runner		97- 05	•	
	50	Runner SP Pureject		98- 05	•	
	50	Stalker		97-	•	
DT	50	Stalker		01-	•	
	50	Storm		94-	•	
	50	Typhoon		93- 95	•	
NRG	50			94-	•	
	70	Runner Malossi		98-	•	
	80	Typhoon		95-	•	
	125	DNA		01-		•
	175	Mad Mud		02-		•
	180	DNA		01-		•
	200	Stalker		97-	•	
<b>HERCULES</b>						
	50	50 Gipsy, Splinter Reggaie		95-	•	
<b>HONDA</b>						
	50	Formula		94-	•	
	50	Sky Classic		00-	•	
	50	Sky Vetro		00-	•	
SFX	50	Sport		96-	•	
SGX	50	Sky DX		97-	•	
SH	50	Fifty, Scoopy		00-	•	
SH	50	T		97	•	
SXR	50			98-	•	
SZX	50	X8R-S		98-	•	
SZX	50	X8R-X		98-	•	
<b>HYOSUNG</b>						
	125	Boomer		03-	•	
	125	Exceed		02-	•	
	125	Grand Prix		98-	•	
	125	Hyper		99-	•	
GPS	125	D		00-	•	
	150	Exceed		02-	•	
	150	Grand Prix		98-	•	
<b>ITALJET</b>						
	50	Formula		94-		•
	80	Formula		94-		•
	125	Formula		94-		•
<b>KEEWAY</b>						
	125	Am		06-	•	
	150	Am		06-	•	
<b>MACAL</b>						
	50	Flash		99-	•	
<b>MALAGUTI</b>						
	50	Ciak		00-	•	
	50	Ciak Twin Disk		02-		•
	50	Yesterday		97-	•	
EL	50	Crosser		97-	•	
F-10	50	Jet-Line		94-	•	
F-10	50	Timemachine		03-	•	
F-10	50	WAP		02-	•	
F-12	50	Phantom A.C.		99-	•	
F-12	50	Phantom Digit		02-	•	•
F-12	50	Phantom L.C. dd		99-	•	•
F-12	50	Racing Life		03-	•	•
F-12	50	Tyre Track		03-	•	•

					
F-15	50	Mechatronic	03-	•	•
SL	50	Centro	96-	•	
	100	Ciak	00-	•	•
F-12	100	Phantom A.C.	00-	•	
F-12	100	Phantom Twin Disk	02-	•	•
	125	Ciak, Ciak Master	02-	•	
F-18	125		00-	•	
	150	Ciak, Ciak Master	02-	•	
F-18	150		00-	•	•
<b>MBK</b>					
	50	Booster 12'	03-	•	
	50	Booster Naked	04-	•	
	50	Booster Spirit	00-	•	
	50	Flipper	99-	•	
	50	Mach G	02-	•	
	100	Nitro	00- 03	•	
YN	100	Ovetto	00- 02	•	
	125	Doodo	01-	•	
	150	Doodo	01-	•	
<b>MOTRON</b>					
	50	Spike	97-	•	
	50	Sting	95-	•	
	50	Syncro	97-	•	
	50	Thunder	95-	•	
<b>PEUGEOT</b>					
	50	50 Buxy (Brembo cal)	94-	•	
	50	50 Speedake (Brembo cal)	94-	•	
	50	50 Speedfight LC, (Brembo cal)	96-	•	
	50	50 Zenith Luxe	94-	•	
<b>PIAGGIO</b>					
	50	Free (Disc Brake version)	97-	•	
	50	Storm	94- 95	•	
	50	Typhoon	94- 95	•	
	50	Typhoon Catalyzed	02-	•	•
	50	Zip Fast Rider	93- 95	•	
LXV	50		08-	•	
NRG	50	Extreme	01-	•	
NRG	50	mc2	97- 99	•	
NRG	50	mc3DD	02-	•	•
NRG	50	mc3DT	02-	•	
NRG	50	PowerDD	05	•	•
NRG	50	PowerDD	06-	•	•
NRG	50	Purejet	05	•	•
NRG	50	Purejet	06-	•	•
NRG.1	50		94- 95	•	
S	50	College 4T	11-	•	
TPH	50		93- 95	•	
	100	Free	02-	•	
	125	Hexagon	94- 95	•	
	125	Typhoon Catalyzed	02-	•	•
LXV	125		08-	•	
SKR	125		94-	•	
	150	Hexagon	94-	•	
LX	150		08-	•	
<b>PROTOS</b>					
	50	Ellisse Scootercar	98-	•	
<b>PUCH</b>					
	50	Storm (Austria)		•	
	50	Typhoon (Austria)	- 95	•	



**QUADRO**

D	350		11- 15	•
---	-----	--	--------	---

**SIAM**

	50	Falcon	97-	•
	50	Scross	97-	•

**SUZUKI**

AY	50	W	00-	•
AY	50	WR	00-	•

**TOMOS**

		Revival	02-	•
		Streetmate	03-	•

**YAMAHA**

	50	Jog R/RR	02- 14	•
	50	Neo's 4	09-	•
	50	Why	99-	•
BW	50	Bump	97-	•
BW	50	Next Generation	96- 07	•
BW	50	Sports Spec R	02-	•
BW	50	Spy	95-	•
YA	50	Axis Mofa	97-	•
YN	50	Neo's, LC	97-	•
	100	Aerox	00- 06	•
	100	Neo's	00- 02	•
XN	125	Teos	01-	•
	150	Teos	02-	•

# 3011 ORGANIC

## Brake Pads

A 54,4 | L 39,8 | S 6,5

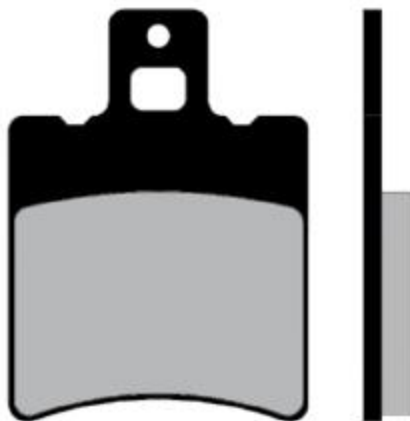

### APRILIA

LX	50	Amico, Sport	92-	•
SR	50	Europa	93-	•
SR	50	UrbanKid	93-	•
SR	50	Viper	93-	•

### ATALA

AT10	25		97-	•
	50	Skeggia	98-	•
AT10	50		97-	•

### MBK

	50	Booster next generation	97-	•
	50	Booster Rocket	95- 02	•
	50	Booster Track	97- 02	•
	50	Equalis	96-	•
	50	Evolis	92-	•
	50	Fizz	93-	•
	50	Forte	94-	•
	50	Nitro	97- 10	•
	50	Ovetto	97- 10	•
	80	Evolis	94-	•

### PGO

	50	Rodshow	01-	•
	90	Rodshow	02-	•

### PIAGGIO

	50	Zip & Zip	94-	•
--	----	-----------	-----	---







### SHE-LUNG

	50	Racer	96-	•
--	----	-------	-----	---

### SUZUKI

AP	50	50	95-	•
AY	50	Katana	96-	•

### TOMOS

					
MC	50	Senior Pro	04-	•	•
<b>YAMAHA</b>					
JOG-Z	50		90-	•	
NS	50	Aerox	13-	•	
YE	50	Zest (Italy)	92- 95	•	
YH	50		98-	•	
YM	50	Breeze, Fizz	95-	•	
YQ	50	Aerox	97- 12	•	
YE	80	Zest (Italy)	93-	•	

# 3012 ORGANIC

## Brake Pads

A 57,0 | L 32,0 | S 5,5

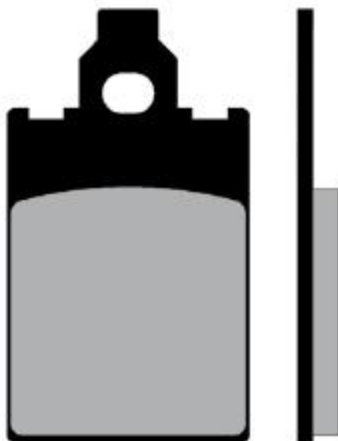

### APRILIA

	50	Red Rose	90-	•
	50	Red Rose Classic	92-	•
	50	Tuareg	86-	•
	50	Tuareg Rally	90-	•
AFI	50	AE	86-	•
AFI	50	Europa, Futura	90-	•
	125	Tuareg Wind	88	•
	240	Climber	89- 90	•
	275	Climber	89- 90	•

### ATK

ATK	560		89- 91	•
ATK	604		91-	•
ATK	604	Quadracer	90-	•

### BETA

ALP			90	•
ALP	50		91-	•
MX	50	Enduro	92	•
TR	125	34	88	•
TR	260	34	86- 88	•

### BENELLI

	50	Chrono	92- 93	•
--	----	--------	--------	---

### DERBI

	75	GPR	89	•
GPR	75	Sport		•

### FANTIC

	50	Fast		•
	50	Oasis	90-	•
	75	Oasis	89-	•

### GARELLI

	50	Sahel	91-	•
--	----	-------	-----	---





**KTM**

GO	50		94-	•
----	----	--	-----	---

**MALAGUTI**

MDX	50	Gold Enduro	87-	•
-----	----	-------------	-----	---

MLX	50	Enduro	87-	•
-----	----	--------	-----	---

	50	Centro	93-	•
--	----	--------	-----	---

F-12	50	Phantom L.C.	94- 98	•
------	----	--------------	--------	---

F-15	50	Fire Fox L.C.	96-	•
------	----	---------------	-----	---

**PEUGEOT**

XPLD	AV		90	•
------	----	--	----	---

**YAMAHA**

DT	50	R	98- 03	•
----	----	---	--------	---

# 3013 ORGANIC

## Brake Pads

A 52,0 | L 32,0 | S 5,5

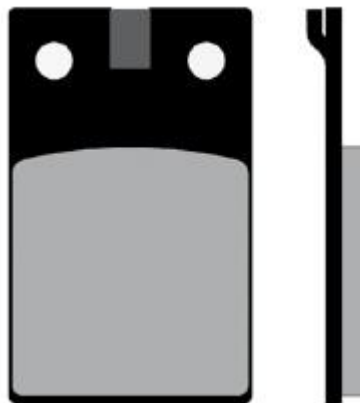

### APRILIA

50	Red Rose	88- 89	•
----	----------	--------	---

### BENELLI

50	Devil	92	•
50	Spring	92	•







### BETA

ALP		90	•	
AE	50	FourTwin	88-	•
ALP	50		91-	•
RV	50		88	•
VRS	50		86-	•
TR	125	32,33	86- 87	•
TR	125	34	88	•
TR	240	33	86- 88	•
	260	Synt	92	•
TR	260	34	86- 88	•

### FANTIC

	50	Trial		•	
	125	Trial		•	
	125	Trial Professional	87	•	•
	125	Trial Progress 1	87-	•	
HP1	125	Strada	85-	•	
	201	Trial		•	
	201	Trial Progress 2	87-	•	
	241	Trial Progress 2	87-	•	
	243	Trial	87-	•	•
	301	Trial	85-	•	
	301	Trial Progress 2	87-	•	
	303	Trial Professional	87-	•	
	343	Trial Progress 2	87-	•	

### GARELLI

					
	323	Trial	86-	•	
<b>GILERA</b>					
	50	503	91-	•	•
R	50		96-	•	
	50	Bullit	90-	•	
<b>JCM</b>					
		Trial	87-	•	
	125	Oxygene	89	•	
	125	Week-End	89	•	
	233	Vega	88	•	
	240	Enduro	91	•	
	240	Oxygene	89	•	
	240	Week-End	89	•	
	250	Week-End	91	•	
	325	Oxygene	89	•	
	325	Week-End	89	•	
	333	Vega	87- 88	•	
<b>KEEWAY</b>					
	125	Speed	06-	•	
	150	Speed	06-	•	
<b>MALAGUTI</b>					
	50	Enduro Dune	87- 88	•	•
CR-1	50	Crosser	95-	•	
F-12	50	Phantom	94- 98	•	
F-15	50	Fire Fox	96-	•	
RST	50	Sport	87-	•	•
	50	Fifty Full, CX, Top	85-	•	
	50	Fifty Mistral	90-	•	
CH	50		86	•	
MGX	450	Ronco	87-	•	
<b>MONTESA</b>					
H7	360	Enduro	86	•	
<b>RIEJU</b>					
	50	Drag	92-	•	
RS1	50		92-	•	
<b>TGB</b>					
	50	Corona	03-	•	
R	50	X	06-	•	
<b>TOMOS</b>					
BT	50	S	89	•	
N	50	AT,BT	91-	•	
CIX	80		89	•	

# Brake Pads

3014 ORGANIC  
4014 SINTERED

A 48,8 | L 35,3 | S 7,0

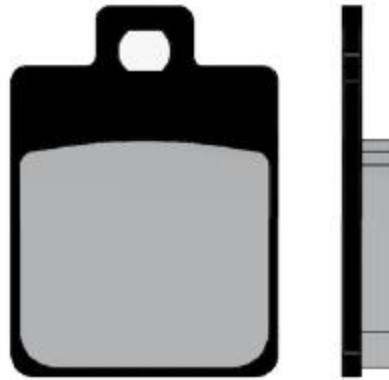

## DERBI

50	Sonar	10-	•
----	-------	-----	---

## GILERA

50	Runner PJ	06-	•
50	Runner SP	06-	•
50	Runner SP, Purejet	98- 05	•
50	Stalker	97-	•
DT	Stalker	01-	•
FX	Runner (Grimeca cal)	00-	•
FX	Runner (Hengtong cal.)	00-	•
FX	Runner SP (Grimeca cal)	00-	•
FX	Runner SP (Hengtong cal.)	00-	•
ST	Runner	12-	•
FXR	Runner (Grimeca cal)	00-	•
FXR	Runner (Hengtong cal.)	00-	•
FXR	Runner SP (Grimeca cal)	00-	•
FXR	Runner SP (Hengtong cal.)	00-	•
200	Stalker	97-	•
FX	Runner SP	98-	•
RC	Fuoco ie	08-	•

## PEUGEOT

50	Tweet Evo RS	14-	•
50	Tweet RS	10- 13	•
125	Tweet Evo	14-	•
125	Tweet Evo RS	14-	•
125	Tweet RS	10- 13	•
150	Tweet RS	10- 13	•

## PIAGGIO

50	Liberty	97- 14	•
50	Liberty 4T	00-	•
50	Zip Disco	96-	•



	50	Zip Fast Rider	96-	•
	50	Zip RST	96- 97	•
	50	Zip RST	98- 99	•
	50	Zip Sport Production	96-	•
ET2	50		97-	•
ET4	50		00-	•
LX	50	2T/4T	05-	•
S	50	2T	07-	•
S	50	4T	09-	•
	125	MP3	06- 07	•
	125	MP3 Efi	08- 11	•
	125	MP3 Hybrid	09- 12	•
	125	MP3 Yourban	11- 12	•
	125	Sfera	95-	•
	125	Zip II 4T	00-	•
ET4	125		96-	•
LE	125	Liberty	99-	•
LX	125	4T	05-	•
PX	125		02-	•
PX	125	70	16-	•
S	125	4T	07-	•
	150	Liberty	99-	•
ET4	150		02-	•
PX	150		02-	•
	200	Liberty	06-	•
PX	200		02-	•
	250	LX 60	06-	•
	250	MP3	06- 07	•
	250	MP3 Efi	08- 09	•
	250	MP3 LT iE	09	•
	300	MP3 Hybrid	11-	•
	300	MP3 Hybrid iE	11-	•
	300	MP3 iE	10-	•
	300	MP3 LT	13-	•
	300	MP3 LT Business	13-	•
	300	MP3 LT Touring	11- 12	•
	300	MP3 Touring	11- 12	•
	300	MP3 Yourban iE	11-	•
	400	MP3 iE	07- 10	•
	400	MP3 LT iE	09- 10	•
	400	MP3 LT Touring	11- 12	•
	400	MP3 Touring	11- 12	•
	500	MP3	10-	•
	500	MP3 LT Touring Business	11- 13	•
	500	MP3 LT Touring Sport	11- 13	•
	500	MP3 Touring Business	11- 12	•
	500	MP3 Touring Sport	11- 12	•
<b>SYM</b>				
	125	Jet 14	17-	•
	125	Symphony S	11-	•
	125	Symphony SR	11-	•
	125	Symphony ST	15-	•
	150	Symphony S	11-	•
	150	Symphony SR	11-	•
	200	Fiddle III	16-	•

# Brake Pads

3015 ORGANIC  
4015 SINTERED

A 45,0 | L 35,9 | S 6,0

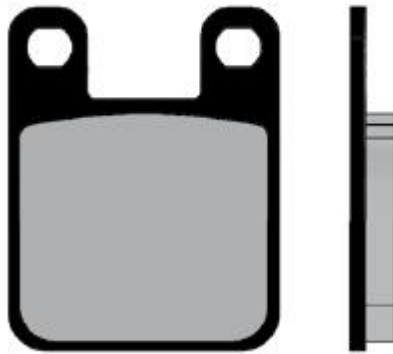

## AJP

MX	200		09-		•
----	-----	--	-----	--	---

## ALFER

MC	80		87-		•
----	----	--	-----	--	---

## APRILIA

RS	50		06-		•
RX	50		06-		•
TX	240		86-		•
	280	R, Climber	92		•
TX	311		86		•
TX	312	M	88		•
TXR	312	M	88		•

## ATK

ATK	560	560	87- 88		•
-----	-----	-----	--------	--	---

## BARIGO







		Scooter electric	97-		•
--	--	------------------	-----	--	---







## BENELLI

BXK	125	125	88		•
-----	-----	-----	----	--	---







## BETA

	50	Eikon	99-		•
	50	Techno	96-		•
	50	Tempo	92- 96		•
RR	50	Enduro	99-		•
RR	50	Pro Race	98-		•
RR	50	Standard	99-		•
RR	50	Supemotard	99- 03		•
RR	50	Supemotard	04- 07		•
SR		34	89		•
	50	Rev	00-		•
	50	Super Trial	92		•
ST	50		97-		•

					
	80	EVO Junior	10-	•	•
	80	Rev	00- 07	•	•
	125	Eikon	99- 03	•	•
ALP	125		99-	•	•
ALP	125	4-stroke	00- 05	•	•
TR	125	34,35	89- 90	•	•
TRIAL	125		97-	•	
	150	Eikon	99- 03	•	•
ALP	200	4-stroke	00- 05	•	•
	240	Super Trial	92	•	
ALP	240		92	•	
ALP	240		96-	•	
	250	Eikon	99-	•	•
	250	Techno	96-	•	•
	250	Zero	91-	•	
ALP	250		92	•	
ALP	250		97-	•	•
	260	Zero	91-	•	
ALP	260		96-	•	
TR	260	34,35,ZERO	89- 92	•	
<b>BLATA</b>					
	125	Enduro	07-		•
	125	Motard	07-		•
<b>BULTACO</b>					
	50	Astro	01-		•
	50	Lobito	99-		•
<b>CAGIVA</b>					
	50	Corsa	98-	•	
	50	Mantis	99-	•	
	50	Mito	99-		•
	50	Progress	98-	•	
<b>CPI</b>					
	50	Supermoto, Supercross	03-	•	•
	125	Supermoto	07-	•	
<b>DERBI</b>					
	50	Atlantis	99-	•	
	50	Atlantis 4T	04-	•	
	50	Atlantis Bullet	04-	•	
	50	Atlantis H2O	01-	•	
	50	Atlantis H2O Wave	01-	•	
	50	Atlantis Wave	01-	•	
	50	Aventura	96-	•	
	50	Black Devil	04-		•
	50	DRD Pro corse	06-		•
	50	DRD Racing R	05-		•
	50	DRD Racing R Ltd.	05-		•
	50	DRD Racing SM	05-		•
	50	DRD Racing SM Ltd.	05-		•
	50	Fenix	94-	•	•
	50	Furax	96-	•	•
	50	Hunter	97-	•	
	50	Manhattan	99-	•	
	50	Predator LC	99-	•	•
	50	Predator O2	00-	•	•
	50	Rambla	06-	•	•
	50	Savannah	91-	•	
	50	Senda L	99-	•	•
	50	Senda RDRD	03- 04		•
	50	Senda R, X-Treme	94- 04	•	•

					
	50	SendaSMDRD	03- 04	•	•
	50	Senda SMDRD Black Edition	03-		•
	50	Senda SM, X-Treme	99-	•	•
	50	Stinger	96-	•	
	50	Vamos FL	95-	•	
	50	Vamos L	95-	•	
	50	Vamos R (A.I.P. cal.)	95-	•	
	50	Variant Sport-R	01-	•	
	50	X-Race R	05-	•	•
	50	X-Treme R	05-	•	•
GP	50		01-	•	
GPI	50		01-	•	•
GPR	50	R	98-		•
GPX1	50		06-		•
ST	50	Paddock	96-	•	
FD		Yumbo	84-	•	
FD		Yumbo Extra	87-	•	
FDS			87-	•	
FDI			87-	•	
FDI		Coppa	85	•	
DS	50		88	•	
FDX	50		89	•	
GPI	50		05-		•
GPR	50	Nude	04-		•
GPR	50	Racing	04-		•
	75	GPR	89		•
	75	Sport, Coppa	84-	•	
GPR	75	Sport			•
GPR	80	Cup	04-		•
	100	Atlantis 4T	04-	•	
	100	Atlantis O2/H2O	01-	•	
	125	Senda R4T	04-		•
	125	Senda X-Treme SM4T	04-		•
	125	Predator	99-	•	
	125	Terra	07	•	
GPI	125		05-		•
GPR	125		05-		•
GPR	125	Nude	05-		•
GPR	125	Racing	09-		•
<b>FACTORY</b>					
RP	50	Desert	04-		•
SM	50	Chrono	04-		•
SP	50	Chrono	04-		•
YR	50	Desert	04-		•
R12	50	Phantom Agua	06-		•
R14	50	Phantom Agua	04-		•
R14	50	Phantom Agua	03-	•	
R2	65	Phantom	04-		•
YR	125		06-		•
<b>FANTIC</b>					
	50	Trial .5 .7 .9	89-	•	•
	250	K-Roo	93-	•	•
	305	305	89	•	•
	307	Trial	91-	•	•
<b>GAC</b>					
		New T.T.	87	•	
<b>GARELLI</b>					
	50	Ciclone LC, SM	86	•	
	50	Sahel	91-		•



					
	50	X0	12-		•
GSP	50		12-		•
<b>GAS GAS</b>					
TXT	50	Boy	04-	•	•
	125	Delta	91	•	
	125	Pampera	96- 03	•	•
	125	Trial	91	•	
	200	Pampera	99-	•	•
TX	200		97-	•	•
	250	Pampera	96- 99	•	•
	250	Trial	89-	•	•
GT	250	Contact		•	•
TX	270		97-	•	•
TX	320		97-	•	•
	325	Halley PXC		•	•
	327	Trial		•	•
GT	327	Contact		•	•
	370	Pampera	96-	•	•
<b>GILERA</b>					
	50	H@k	99-	•	•
	50	Zulu	01-	•	•
GSM	50	Supermotard	01-	•	•
RCR	50		04-	•	•
SMT	50		04-	•	•
	125	GSM	00-	•	•
SC	125		06-		•
	125	Surfer	00-	•	•
<b>GMA</b>					
		4 Piston front Model F			
<b>HERO ENVOY</b>					
	50		99-	•	
<b>HRD</b>					
	50	Sonic 2 Supermotard	00- 02		•
	50	Sonic 2 Trail	00- 02		•
	125	Supermotard	00- 02		•
	125	Trail	00- 02		•
<b>HUSQVARNA</b>					
	50	Racing	98-	•	
SM	50		02-		•
WR	50		02-		•
WRS	50		98-	•	
	50	50 Husky Boy J, R, S	01-	•	
<b>ITALJET</b>					
	50	Dragster	99-	•	•
	50	Formula Air	99-	•	
	50	Formula L.C.	98-	•	•
	50	Torpedo	98-	•	
	50	Torpedo 4T	01-	•	
	125	Dragster	99-	•	•
	125	Formula L.C.	99-	•	•
	125	Jupiter	02-		•
	125	Torpedo	99-	•	
	125	Twin	98-	•	•
	150	Jupiter	02-		•
	150	Torpedo 4T	01-	•	
	180	Dragster	99-	•	•
<b>J. J. COBAS</b>					
		TR1	85		•
		Trial	85	•	

**JAYBRAKE**

2 Piston Dual Series Caliper

4 Piston Quad Series Caliper

**JCM**

125	Europa	89	•	•
125	SR	89	•	•
240	Europa	89	•	•
240	SR	89	•	•
325	Europa	89	•	
325	SR	89	•	•

**KTM**

SX	60	99	•	
SX	65	00- 01	•	

**MACAL**

AM5/6	50	Trophy	99-	•
AM5/6	50	Trophy H2O	99-	•

**MACBOR**

XC	50	510 Racing	04-	•
XC	50	512 Racing	04-	•
XC	50	515 R 6V	04-	•

**MALAGUTI**

	50	Fifty	04-	•
NKD	50		04-	•
XSM	50		03-	•
XIM	50		03-	•
	50	Fifty Evolution	91-	•
NKD	50	50 Dragon	06-	•

**MBK**

	50	X-Limit	04-	•
	50	X-Power	04-	•

**MINARELLI**

MR	80			•
----	----	--	--	---

**MONTESA**

	125	Cota	88	•	•
	260	Evasion	92	•	
	304	Cota	88	•	•
	307	Cota	89	•	•
	307	Cota Trial	88-	•	•
	309	Cota	89-	•	
	310	Cota	89-	•	
	311	Cota Trial	92	•	
	315	Cota R	97-	•	•
	335	Cota	87- 91	•	•
M7	360	Enduro	85	•	

**MORBIDELLI**

	125			•	•
--	-----	--	--	---	---







**MOTORHISPANIA**







MH	50	Furia 6v	99-	•	•
MH	50	Furia Max	06-	•	•
MH	50	Urban Bike	06-		•
RX	50	Racing	00-		•
RYZ	50	Enduro	05-	•	•
RYZ	50	Supermotard	05-		•
RYZ	125	Arena Enduro	05-	•	

**PERFORMANCE MACHINE**

	125	X2			
	125	X 4S			
	125	X 4SL			

**PEUGEOT**

						
	50	Blaster		09-	•	
	50	Blaster Furios		11-	•	•
	50	Blaster RS12		09-	•	
	50	Buxy (A.I.P. cal.)		94-	•	
	50	Elyseo		02-	•	•
	50	Elyseo (A.I.P. cal.)		99- 01	•	
	50	Elystar		03-	•	
	50	Jet C-Tech		09-	•	•
	50	Jet-Force		03-	•	•
	50	Looxor		02- 05	•	
	50	Looxor		06-	•	•
	50	Ludix		04-	•	
	50	Speedake (A.I.P. cal)		94-	•	
	50	Speedfight 2 A/C		01-	•	
	50	Speedfight 2 L/C		01-	•	•
	50	Speedfight 2 X-Race, Furious, 206 WRC		01-	•	•
	50	Speedfight LBD/LBDP		00-	•	•
	50	Speedfight LC, (A.I.P. cal.)		96-	•	
	50	Speedfight Lemans		11-	•	•
	50	Squab (A.I.P. cal.)		94-	•	
	50	TKRFurious		05-	•	
	50	TKR WRC		05-	•	
	50	Trekker Metal-X		01-	•	
	50	Trekker Road		99-	•	
	50	Trekker Streetboard		00-	•	
	50	Trekker Urban Black		00-	•	
	50	Vivacity (A.I.P. cal.)		99- 07	•	
XP6	50	Enduro		06-	•	•
XP6	50	Supermotard		06-	•	•
XP6	50	Trail		04- 05	•	•
XPS-6	50	Enduro		02-	•	•
XPS-6	50	Supermotard		04-	•	•
XR6	50	Race Spec		02- 07	•	•
XR7	50			08-	•	•
	100	Elyseo		02-	•	•
	100	Elyseo (A.I.P. cal.)		99- 01	•	
	100	Looxor		02-	•	•
	100	Speedfight		00-	•	•
	100	Speedfight 2, X-Race		01-	•	•
	100	Trekker Road		99-	•	
	100	Vivacity (A.I.P. cal)		99- 07	•	
	125	Elyseo (A.I.P. cal.)		99	•	
	125	Ludix		04-	•	
	125	Satelis		04- 05	•	
XPS	125	GT		06-	•	
<b>PIAGGIO</b>						
	50	Diesis		02-	•	
	100	Diesis		02-	•	
<b>PUCH</b>						
		Condor		90-	•	
TZX	50			92	•	
	75	Cobra		85-	•	•
<b>RIEJU</b>						
	50	First, H2O		97-	•	
	50	Racing Spec. Edition		01-		•
	50	Spike Racing		02-	•	•
	50	Spike Racing		02-		•
	50	Tango		08-		•
	50	Windy		97-	•	

					
MRX	50	Racing	02-	•	•
MRX	50	Pro	05-		•
NKD	50		04- 07		•
RRX	50		08-	•	•
RRX	50	Spike	08-	•	•
RS1	50	Castrol	01-		•
RS1	50	Evolution	96- 00	•	•
RS3	50	Pro	12-		•
SMX	50		02-	•	•
SMX	50		02-		•
SMX	50	Pro	08-		•
	50	Drac	97-	•	•
	50	FD4 Super Marathon	85	•	
	50	Tango	10-		•
RR	50	Supermotard	96-	•	•
RS1	50		92-		•
RV	50			•	
	75	K6 LC Strada	87	•	
	75	P6 LC Strada	87	•	
MR	80	C, E	88-	•	
MR	80	Cross	87	•	
MR	80	Enduro	87	•	
RST	80		91-	•	•
	125	Tango	06-		•
	125	Tango	08-		•
	125	Tango Pro	08-		•
MRX	125		03-		•
MRX	125		03-	•	•
RR	125		97-	•	•
RS3	125		10-		•
SMX	125		03-		•
SMX	125		03-	•	•
	250	Tango	08-		•
<b>ROXON</b>					
	50	Duel SM	06-	•	•
	50	Duel TT	06-	•	•
<b>SCORPA</b>					
TYS	115	F Trial	06-	•	
TYS	125	F Trial	06-	•	
<b>SHERCO</b>					
	50	Supermotard, Enduro	02- 06		•
	80	0.8	01-	•	•
	125		02-		•
	125	City Corp 4T Enduro	03-		•
	125	City Corp 4T SM	03-		•
ST	125	1.25	01- 05	•	•
ST	200	2.0	01-	•	•
ST	250	250	99- 00	•	•
<b>SIMSON</b>					
	125	Star	99-	•	
	125	SM	01-		•
<b>SJP</b>					
		2 Piston Caliper (30-375)			
		4 Piston Caliper (30-370)			
<b>SUZUKI</b>					
AY	50	Katana	96-	•	
AY	50	W	00-		•
AY	50	WR	00-		•
DR	50	Big	89-	•	



RMX	50		00-	•	•
SMX	50	Super Motard	00-	•	•
UF	50	Estilete	00-	•	
UX	50	W Zillion	99-	•	
<b>TOMOS</b>					
	50	HipHop	06-	•	
	50	Racing	06-	•	
	50	Street Soul	06-	•	
	50	Youngstr	06-	•	
SE	50		05-		•
MC	125	T	06-		•
SE	125		05-		•
SM	125	F (Rad.cal)	06-		•
<b>YAMAHA</b>					
DT	50	R	04-	•	
TZR	50		03-		•
XT	125	R	05-		•
XT	125	X Supermotard	05-		•
TY	250	R	91- 92	•	
TY	250	Z	93- 96	•	•

# 3016 ORGANIC

## Brake Pads

A 52,4 | L 45,5 | S 7,0

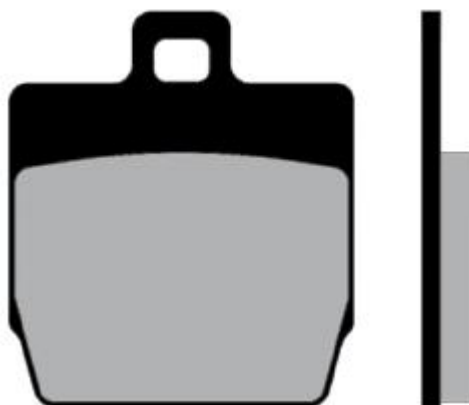

Brand	Size	Model	Year	Icon 1	Icon 2
<b>CPI</b>	50	GTS	02-		•
<b>MBK</b>	50	Nitro	97- 10		•
	50	Stunt	00- 10	•	
<b>QUADRO</b>	350	3	16-	•	
	350	4	16-	•	
<b>YAMAHA</b>	50	Slider	00- 05	•	
NS	50	Aerox	13-		•
YQ	50	Aerox	97- 12		•

# Brake Pads

3017 ORGANIC  
4017 SINTERED

A 42,0 | L 77,0 | S 7,5  
A 42,0 | L 94,5 | S 7,5

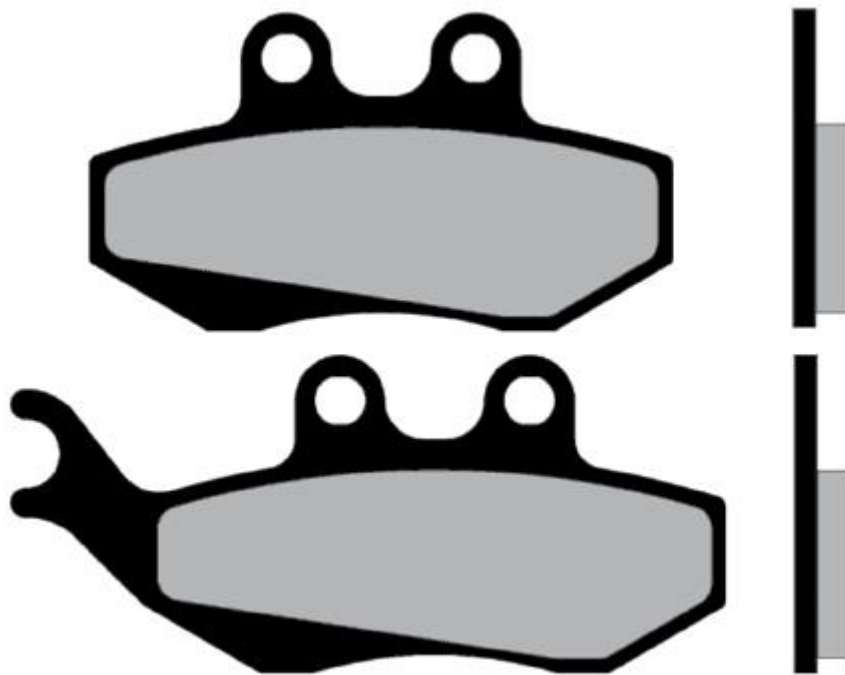

## APRILIA

	50	Tuono	04-	•
MX	50		03-	•
RS	50	Replica	00- 05	•
RX	50		90-	•
RX	50	Racing	04- 06	•
ETX	125		99-	•
RX	125		92	•
	125	Pegaso	92-99	•

## AJP







PR3	125	Enduro	08- 12	•
PR3	125	Supemotard	08- 12	•
MX	200		09-	•
PR3	200	Enduro	08- 12	•
PR3	200	Supemotard	08- 12	•

## BENELLI

	400	Velvet Dusk	03-	•
--	-----	-------------	-----	---

## BETA

RR		Enduro	10-	•
RR		Supemotard	08-	•
RR	50	Enduro Alu	04- 07	•
RR	50	Supemotard Alu	04- 05	•
	125	M4	06-	•
	125	Urban	10-	•
ALP	125	4-stroke	06-	•
RR	125	Enduro 4T	10-	•
RR	125	Supemotard	08-	•

						
	200	Urban		10-	•	
ALP	200	4-stroke		06-	•	
ALP	350	4.0		04-	•	
<b>CPI</b>						
	50	GTR		02	•	
	50	GTS		02-	•	
	125	GIR,GIS		02-	•	
	200	GIR,GIS		02-	•	
<b>DERBI</b>						
	50	Black Devil		04-	•	
	50	DRD Racing R		05-	•	
	50	DRD Racing R Ltd		05-	•	
	50	DRD Racing SM		05-	•	
	50	DRD Racing SM Ltd		05-	•	
	50	Senda SM DRD Black Edition		03-	•	
	125	Senda Baja		06-	•	
	125	Mulhacen		07	•	
	125	Senda R4T		04-	•	
	125	Senda X-Treme SM4T		04-	•	
<b>FACTORY</b>						
RP	50	Desert		04-	•	
SM	50	Chrono		04-	•	
SP	50	Chrono		04-	•	
YR	50	Desert		04-	•	
<b>FANTIC</b>						
	50	Regolama Casa		08-	•	
	50	Supersei Motard		08-	•	
	125	Regolama Casa		08-	•	
	125	Supersei Motard		08-	•	
<b>GAS GAS</b>						
EC	50	Rookie		05-	•	
	125	Pampera		04-	•	
	250	Pampera		02-	•	
	280	Pampera		04-	•	
<b>GENERIC</b>						
	50	Toxic		07-	•	
	50	Trigger SM		06-	•	
	50	Trigger SM Competition		08-	•	
	50	Trigger X		06-	•	
	50	50 Trigger X Competition		08-	•	
<b>GILERA</b>						
	50	DNA		01-	•	
	125	DNA		01-	•	
FX	125	Runner (Grimeca cal.)		00-	•	
FX	125	Runner SP (Grimeca cal.)		00-	•	
VX	125	Runner 4T (Grimeca cal.)		01-	•	
	175	Mad Mud		02-	•	
	180	DNA		01-	•	
FXR	180	Runner		98- 99	•	
FXR	180	Runner (Grimeca cal.)		00-	•	
FXR	180	Runner SP (Grimeca cal.)		00-	•	
VXR	180	Runner 4T (Grimeca cal.)		01-	•	
FX	200	Runner SP		98-	•	
VXR	200	Runner 4T (Grimeca cal.)		01-	•	
<b>HM</b>						
CRE	50			06- 13	•	
<b>KEEWAY</b>						
	125	Enduro		07-	•	
	125	X-Ray		07-	•	



**MALAGUTI**

XSM	50		03-	•
	50	Fifty	04-	•
NKD	50		04-	•
R	125	Madison	99-	•
	125	Phantom Max	04-	•
	150	Madison	99-	•
	180	Madison	02-	•
S	200	Madison	03-	•
	200	Phantom Max	04-	•
	250	Password	06-	•
	250	Phantom Max	05-	•
RS	250	Madison	05-	•

**MBK**

	50	X-Power	04-	•
--	----	---------	-----	---

**MOTORHISPANIA**

MH	50	Urban Bike	06-	•
----	----	------------	-----	---

**PEUGEOT**

XPS-6	50	Supermotard	04-	•
	125	Elyseo	00-	•
	125	Elystar	03-	•
	125	Jet-Force Compressor	03-	•
	125	Satelis	06-	•
	150	Elyseo	00-	•
	150	Elystar	03-	•
	400	Geopolis (AJP cal.)	07-	•

**PIAGGIO**

GIX	125	SuperHexagon (Grimeca cal.) (11" wheels)	00-	•
LX	125	Hexagon	99-	•
LX	125	Skipper, ST	99-	•
LX4	125	Hexagon	99-	•
GIX	180	SuperHexagon (Grimeca cal.) (11" wheels)	00-	•
LXT	180	Hexagon	99-	•
BV	200		05-	•
GT	250	Hexagon	99-	•
GIX	250	Super Hexagon	01-	•

**RIEJU**

RS1	50	Castrol	01-	•
-----	----	---------	-----	---

**SHERCO**

SE	50	Enduro	07-	•
SM	50	Supermotard	07-	•
SE	125	1.25 F	10-	•

**YAMAHA**

DT	50	X Supermotard	04-	•
TZR	50		03-	•
XT	125	X Supermotard	05-	•

# Brake Pads

3018 ORGANIC  
4018 SINTERED

A 53,4 | L 44,6 | S 8,7

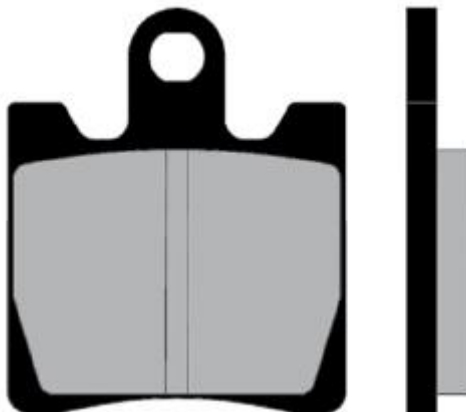

## DAELIM

	125	Otello	08-	•
	125	S2 FI	07-	•
SL	125	U3 FI	07-	•
SV	125	S3	11-	•

## KAWASAKI

SC	250	Epsilon	02-	•
----	-----	---------	-----	---

## SUZUKI

	250	Sky Wave Type II	98-	•
AN	250	Burgman	98- 06	•
AN	400	Burgman	99- 06	•

## SYM

	125	GTS	07-	•
	125	Joymax Sport	16-	•
	250	GTS	07-	•
	250	Joymax Sport	16-	•
RV	250	Efi	10-	•
	300	Joymax Evo	10-	•
	300	Joymax Sport	16-	•
	300	Joyride Evo i	10-	•
GIS	300		09-	•
GIS	300	Evo i	11-	•
	500	GT	07-	•

## TRIUMPH

	1200	TrophySE	13-	•
--	------	----------	-----	---

## YAMAHA

FJR	1300	A	13- 15	•
FJR	1300	A	16-	•
FJR	1300	ABS	06- 12	•
FJR	1300	AE	16-	•
FJR	1300	AS	13- 15	•
FJR	1300	AS	16-	•
XV	1900	A	11-	•

# Brake Pads

3019 ORGANIC  
4019 SINTERED

A 41,0 | L 94,2 | S 10,0

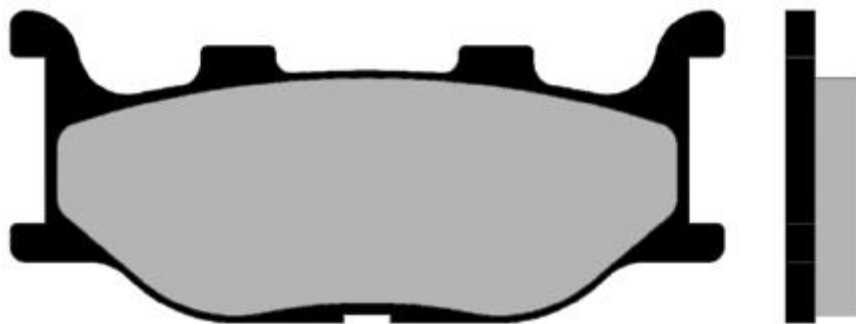

## BAOXIN

BX	125	L	97-	•
----	-----	---	-----	---

## ITALJET

	125	Jupiter	02-	•
	150	Jupiter	02-	•
	250	Jupiter	01-	•

## JIANSHE

JS	125	3	02-	•
----	-----	---	-----	---

## JINCHENG

JC	150	TD	06-	•
----	-----	----	-----	---

## KEEWAY

	250	Supershadow	06-	•
--	-----	-------------	-----	---

## LONCIN

LX	150	6	02-	•
----	-----	---	-----	---

## MBK

	250	Skyliner	00-	•
	400	Skyliner	04-	•

## MZ

	1000	(MUZ)S	01- 02	•
--	------	--------	--------	---

## QUINGOI

QM	125	2V	02-	•
----	-----	----	-----	---

## YAMAHA

SR	125		97- 02	•
TDR	125	R	93- 03	•
TZR	125		93	•
XV	125	Virago	97- 00	•
XVS	125	Drag Star	00-	•
XV	250	S Virago	95- 07	•
XVS	250	Drag Star	01-	•
YP	250	DMajesty DX	98-	•
YP	250	Majesty	96-	•



YP	250	Majesty DX/ABS	99	•
SR	400		14-	•
YP	400	Majesty	05-	•
XP	500	TMAX	04- 07	•
FZ6	600		04-	•
FZ6	600	Fazer	04-	•
FZ6R	600		09-	•
XJ	600	N	98-	•
XJ	600	S Diverion	98- 03	•
XJ6	600	Diverion	09-	•
XJ6-F	600		09-	•
XJ6-N	600		09-	•
XJ6-S	600		09-	•
MT-03	660		06- 13	•
XV	1100	Virago	99	•
XVS	1100	Drag Star	99- 06	•
XVS	1100	Drag Star Classic	00- 06	•
XVS	1300	A Midnight Star	07- 11	•
XVS	1300	Custom	14-	•

# Brake Pads

3020 ORGANIC  
4020 SINTERED

A 53,5 | L 50,8 | S 9,3

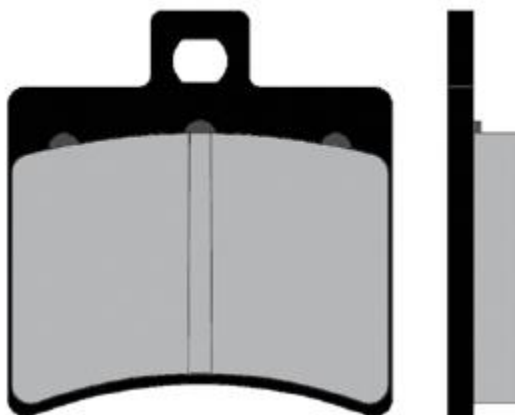

## APRILIA

	50	Scarabeo Ditech	02-	•
SR	50	Ditech	01- 06	•
SR	50	Racing	00-	•
SR	50	Street	05- 12	•
	125	Atlantic	03-	•
	125	Scarabeo, Scarabeo GT	99-	•
	125	Sportcity	04- 12	•
RS	125		06-	•
	150	Scarabeo	99-	•
	150	Scarabeo, Scarabeo GT	04-	•
	200	Atlantic	03-	•
	200	Scarabeo	07-	•
	200	Scarabeo Class	10-	•
	200	Scarabeo ie	12-	•
	200	Scarabeo, Scarabeo GT	02- 03	•
	200	Sportcity	04- 08	•
	250	Atlantic ie	07-	•
	250	Leonardo	99-	•
	250	Leonardo (Grimeca cal.)	99-	•
	250	Scarabeo, Scarabeo ie	06-	•
	250	Sportcity ie	06- 08	•
	300	Scarabeo Special	10-	•
	400	Scarabeo ie	07-	•
	500	Atlantic Left/Rear	02- 05	•
	500	Atlantic Sprint	06-	•
	500	Scarabeo	03- 06	•
	500	Scarabeo Class	10-	•
	500	Scarabeo ie	07-	•

## BETA

	50	Eikon	04-	•
--	----	-------	-----	---



	125	Eikon	04-	•
	150	Eikon	04-	•
<b>DERBI</b>				
	125	Rambla	08-	•
	300	Rambla	08-	•
<b>MALAGUTI</b>				
	125	Phantom Max	04-	•
	125	Sport City Cube	08-	•
F-18	125	Warrior	00-	•
R	125	Madison	99-	•
	150	Madison	99-	•
	180	Madison	02-	•
	200	Phantom Max	04-	•
	200	Sport City Cube	08-	•
S	200	Madison	03-	•
	250	Madison	99-	•
	250	Password	06-	•
	250	Phantom Max	05-	•
	250	Sport City Cube	08-	•
RS	250	Madison	05-	•
	300	Sport City Cube	08-	•
K	400	Madison	02-	•
<b>HYOSUNG</b>				
GD	250	EXIV-R	15-	•
GT	250	iR	15-	•
GT	300	R	16-	•
GT	650	iR	15-	•

# Brake Pads

3021 ORGANIC  
4021 SINTERED

A 42,0 | L 77,0 | S 9,0  
A 42,0 | L 96,5 | S 9,0

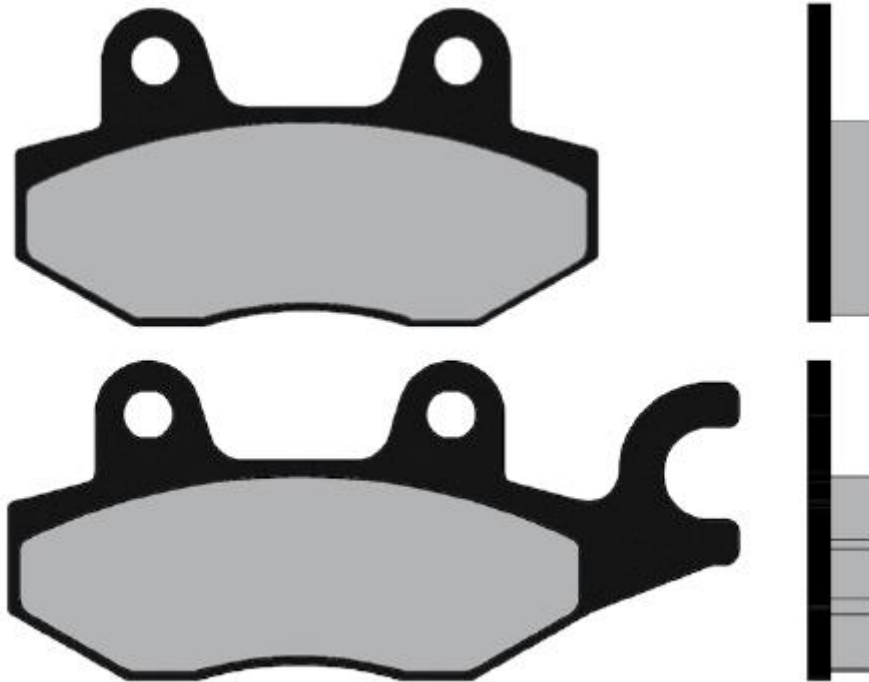

## AEON

125	Oz	14-	•
125	Urban	14-	•

## CF MOTO

125	Papio	17-	•
-----	-------	-----	---

## DAELIM

125	S3	11-	•
125	Roadwin	04-	•
250	Roadwin	08-	•

## HONDA







NS-1	75	92-	•	
NSR	80	R	93-	•
NSF	100	06-	•	
VT	125	C1Shadow	99-	•
VT	125	C2Shadow	99-	•
XLV	125	Varadero	01-	•
NSR	150	02-	•	
CBF	250	04-	•	
CB	300	10-	•	

## ITALJET

50	Rollercraft	08-	•
125	Torpedo	08-	•
150	Torpedo	08-	•

## KEEWAY

100	Partner	06-	•
110	Partner	06-	•

					
	125	Speed	06-		•
	150	Speed	06-		•
<b>KYMCO</b>					
	50	B&W	04-	•	
	50	Dink, Dink Sport, B&W	99-	•	
	50	K-Pipe	12-	•	
	50	New Dink	08-	•	
	50	Spacer	99-	•	
	50	Super-9 A/C	02-	•	
	50	Super-9 L/C	02-	•	
	50	Yager	01-	•	
	100	Cobra Racer	99-	•	
	125	Agility 16+	14-		•
	125	B&W, Dink Sport	99-	•	•
	125	Cruiser	99-	•	
	125	Dink	96-	•	•
	125	Grand Dink	02-	•	•
	125	Hipster	01-	•	
	125	K-Pipe	13-	•	
	125	Movie	99-	•	
	125	Movie XL	01-	•	
	125	New Dink	08-	•	•
	125	Pulsar	01-	•	
	125	Quannon	08-	•	•
	125	Spacer	99-	•	•
	125	TechnoGT	06-	•	
	125	Yager	01-	•	•
	125	YagerGT	09-	•	
	125	Zing	96-	•	
<b>CK-1</b>					
	125		14-	•	
	150	B&W	01-	•	•
	150	Dink	99-	•	•
	150	Grand Dink	02-	•	•
	150	Hipster	01-	•	
	150	Movie XL	01-	•	
	150	Quannon	10-	•	•
	150	Spacer	99-	•	•
	150	Yager	01-	•	•
	150	Zing	99-	•	
	200	Agility 16+	14-		•
	200	Agility R16	11-		•
	200	Dink	04-	•	•
	200	iNew Dink	08-	•	•
	200	Like i	10-	•	•
	200	Yager	04-	•	•
	250	B&W, Dink Sport	01-	•	•
	250	People	03-	•	
	250	Yup	03-	•	•
	300	People Si Right	08-	•	
<b>LONCIN</b>					
	LX	110	4	02-	•
	LX	125		02-	•
<b>SYM</b>					
	RS	125		05-	•
	RS	150		05-	•
<b>TGB</b>					
		Buffalo		03-	•



# Brake Pads

3022 ORGANIC  
4022 SINTERED

A 31,5 | L 100,0 | S 9,0

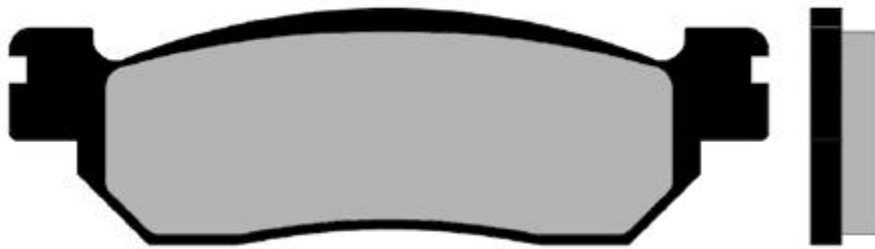

**MBK**

250	Skyliner	00-	.
-----	----------	-----	---

**YAMAHA**

TW	125		99-	.
YP	125	X-Max ABS	11-	.
YP	125	X-Max Business ABS	11-	.
DT	175		00-	.
TW	200		01-	.
	225	Bronco Cellow	97-	.
XT	225		01-	.
XG	250	Tricker	05-	.
VP	250	X-City	07-	.
YP	250	DMajesty DX	98-	.
YP	250	Majesty DX/ABS	99- 14	.
YP	250	X-Max	05- 13	.
XT	250		08-	.
YZF	600	R6	99- 02	.
YZF	1000	R1	02- 03	.

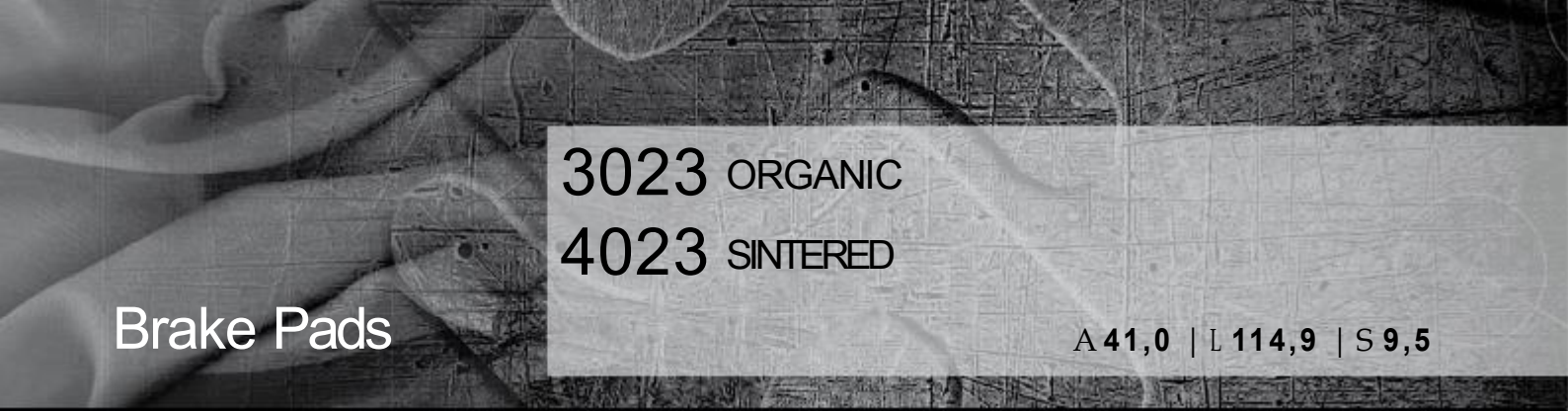

3023 ORGANIC  
4023 SINTERED

Brake Pads

A 41,0 | L 114,9 | S 9,5

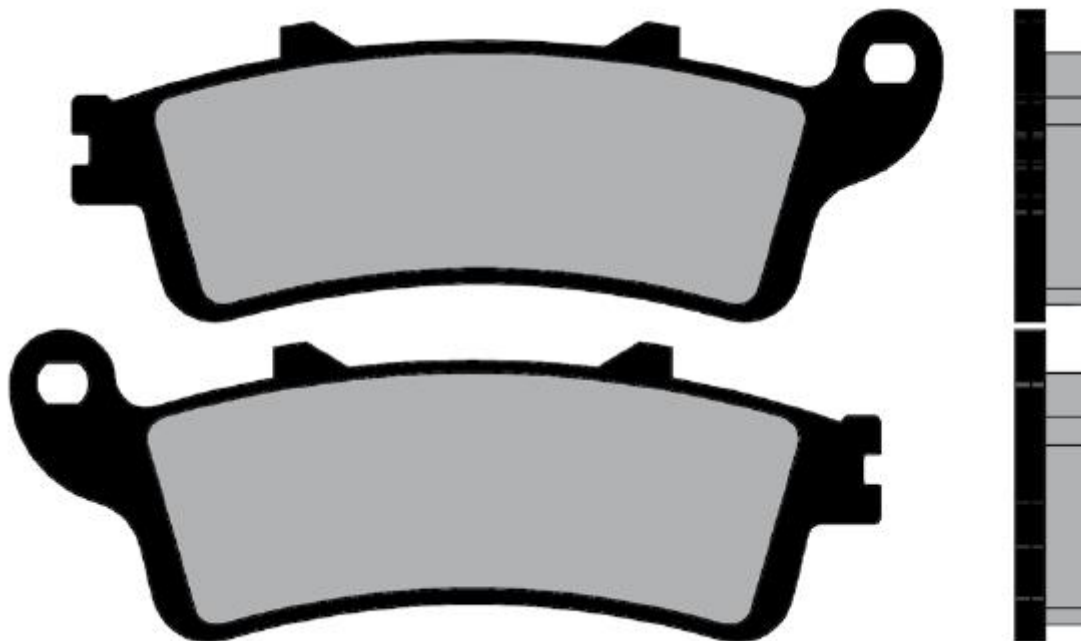

**HONDA**

FES	125	Pantheon	98- 06	•	
FES	150	Pantheon	99- 06	•	
ST	1100	1100 A6 ABS-TCS-CBS	96-		•
ST	1300	1300 Pan European, ABS	02-		•
GL	1800	1800 Gold Wing	01-		•
GL	1800	1800 Gold Wing F6B	13-		•

# Brake Pads

3024 ORGANIC  
4024 SINTERED

A 49,0 | L 55,2 | S 7,0

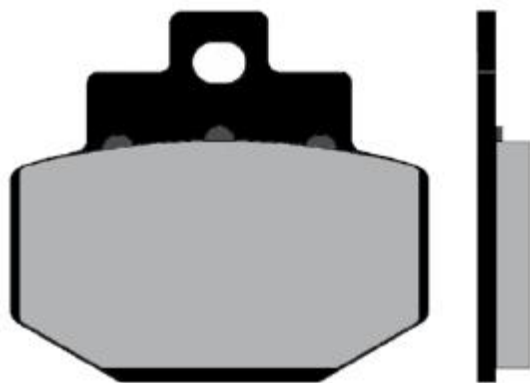

## BENELLI

	125	Adiva	00-	•
	150	Adiva	00-	•

## DERBI

GP1	250		05-	•
-----	-----	--	-----	---

## GILERA

ST	125	Runner	08- 11	•
VX	125	Runner 4T (Grimeca cal.)	01-	•
VX	125	Runner 4T (Hengtong cal.)	01-	•
VXR	180	Runner 4T (Grimeca cal.)	01-	•
VXR	180	Runner 4T (Hengtong cal.)	01-	•
ST	200	Runner	08-	•
VXR	200	Runner 4T (Grimeca cal.)	01-	•
VXR	200	Runner 4T (Hengtong cal.)	01-	•

## PIAGGIO

	125	946	14-	•
GT	125	L	04-	•
GTS	125		07-	•
GTS	125	Super	10- 13	•
GTS	125	Super i.e.	15-	•
GTS	125	Supersport	13	•
GTV	125		08-	•
GTX	125	SuperHexagon (Grimeca cal.) (11" wheels)	00-	•
GTX	125	SuperHexagon (Hengtong cal.) (11" wheels)	00-	•
GTX	125	SuperHexagon (Hengtong cal.) (12" wheels)	01-	•
GTX	180	SuperHexagon (Grimeca cal.) (11" wheels)	00-	•
GTX	180	SuperHexagon (Hengtong cal.) (11" wheels)	00-	•
GTX	180	SuperHexagon (Hengtong cal.) (12" wheels)	01-	•
GT	200	L	04-	•
	250	GT 60	06-	•
GTS	250	ABS	06-	•



GTV	250		08-	•
GIX	250	Super Hexagon	01-	•
GTS	300	i.e.	12-	•
GTS	300	Super	09-	•
GTS	300	Super Sport i.e.	11-	•
GTS	300	Touring ABS	17-	•
GTS	300	Touring i.e.	11- 12	•
GTV	300	i.e.	11-	•
GIX	125	SuperHexagon (Hengtong cal.) (11" wheels)	00-	•
GIX	125	SuperHexagon (Hengtong cal.) (12" wheels)	01-	•
GIX	180	SuperHexagon (Grimeca cal.) (11" wheels)	00-	•
GIX	180	SuperHexagon (Hengtong cal.) (11" wheels)	00-	•
GIX	180	SuperHexagon (Hengtong cal.) (12" wheels)	01-	•
GT	200	L	04-	•
	250	GT 60	06-	•
GTS	250	ABS	06-	•
GTV	250		08-	•
GIX	250	Super Hexagon	01-	•
GTS	300	i.e.	12-	•
GTS	300	Super	09-	•
GTS	300	Super Sport i.e.	11-	•
GTS	300	Touring ABS	17-	•
GTS	300	Touring i.e.	11- 12	•
GTV	300	i.e.	11-	•

# 3025 ORGANIC

## Brake Pads

A 51,1 | L 31,6 | S 5,5

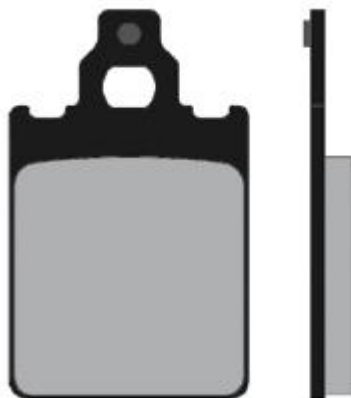

### APRILIA

SR	50	Replica	94-	•
----	----	---------	-----	---

### ITALJET

	50	Formula	94-	•
	80	Formula	94-	•
	125	Formula	94-	•

### PIAGGIO

	50	Quartz	92-	•
	80	Skipper	93- 95	•
	125	Skipper	93- 95	•
	150	Skipper	93-	•

### CAGIVA

	50	Prima	93-	•
	80	City	93-	•
	80	Prima	92-	•

# Brake Pads

3026 ORGANIC  
4026 SINTERED

A 46,9 | L 78,9 | S 7,5

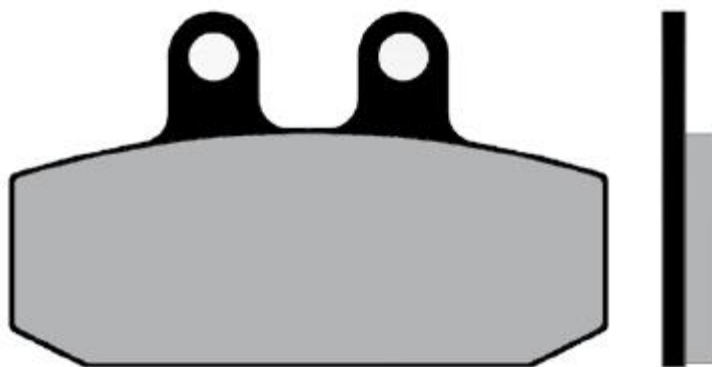

## APRILIA

MX	125	Cross	85	•
	125	Leonardo (Grimeca cal.)	99-	•
	125	Red Rose	89	•
	125	Scarabeo, Scarabeo GT	99-	•
	125	Sportcity	04- 12	•
	150	Leonardo (Grimeca cal.)	99-	•
	150	Scarabeo	99-	•
	125	Tuareg	- 86	•
	125	Tuareg Rally	86-	•
	125	Tuareg Rally	89	•
ETX	125		- 86	•
ETX	125	Tuareg	86- 87	•
	200	Scarabeo, Scarabeo GT	02- 03	•
	200	Sportcity	04- 08	•
	250	Leonardo (Grimeca cal.)	99-	•
	250	Sportcity ie	06- 08	•
	250	Tuareg Rally	86-	•
	300	Leonardo (Grimeca cal.)	05-	•
	350	Tuareg	86-	•
	350	Tuareg Wind	87	•
ETX	350			•
	400		07-	•
	500	Atlantic Left/Rear	02- 05	•
	500	Scarabeo	03- 06	•
	500	Scarabeo Class	10-	•
	500	Scarabeo ie	07-	•
	600	Tuareg	86-	•
ETX	600		86- 92	•
NA	850	Mana GT ABS	09- 13	•
NA	850	Mana ABS	08- 11	•

**CAGIVA**

	50	Blues	89	•
	125	Blues		•
	125	Roadster	94-	•
	200	Roadster	96-	•

**DERBI**

	125	Rambla	08-	•
	300	Rambla	08-	•

**FANTIC**

	250	Raider	85-	•
--	-----	--------	-----	---

**GARELLI**

	125	Tiger XLE	86-	•
--	-----	-----------	-----	---

**GILERA**

	125	Cougar	99-	•
	125	Fast Bike	88-	•
	125	KK, KR, KZ	86-	•
	125	R1, R1S	90-	•
ER	125	Rally	87	•
MXR	125		90	•
RRT	125	Nebraska	87	•
RTX	125		86	•
RX	125	Arizona Hawk	85	•
X1	125		89	•
XR2	125		90	•
	200	Arizona Hawk	85	•
	200	ER	87	•
	200	Fast Bike		•
	250	Arizona Rally		•
	350	Dakota		•
XRT	350		90-	•
	500	Dakota	86	•
RC	600		88	•
XRT	600		89	•

**HONDA**

CA	125	Rebel	97-	•
CLR	125	Cityfly	99- 03	•
CRM	125	R	90- 98	•
MTX	125	Camel, Italy	88-	•
MTX	125	R, Italy	86	•
NS	125	Italy	85- 88	•
NSR	125	F, R	90- 92	•
NSR	125	R, Italy	89-	•
NX	125	Transcity	90- 98	•
RTV	125	NRS, Italy	87-	•
XL	125	R, P.D., Italy	85	•
XL	125	R, P.D., Italy, EX	87-	•
XL	200	R, P.D., Italy	85-	•

**MALAGUTI**

	125	Runner	87-	•
	125	Sport City Cube	08-	•
	200	Sport City Cube	08-	•
	250	Sport City Cube	08-	•
	300	Sport City Cube	08-	•
GT	500	Spidermax	04-	•
RS	500	Spidermax	09-	•

**MOTO-GUZZI**

V7	750	Racer	12- 14	•
V7	750	Stone	12- 14	•
V7 II	750	Racer	15-	•



V7 II	750	Scrambler	16-	•
V7 II	750	Special	15-	•
V7 II	750	Stone	15-	•
V7 II	750	Stornello	16-	•
V7 II	750	Stornello Ltd Edition	17-	•
V7 III	750	Anniversario	17-	•
V7 III	750	Racer	17-	•
V7 III	750	Special	17-	•
V7 III	750	Stone	17-	•
V9	850	Bobber	16-	•
V9	850	Roamer	16-	•
V9	850	X-Track	17-	•

**MOTO-MORINI**

	350	Excalibur	87-	•
	350	Kanguro	88	•
	501	Camel	88	•
	501	Excalibur	87	•

**SACHS**

	125	Roadster V2	01-	•
ZX	125		99-	•
ZZ	125		99-	•

**SIMSON**

	125		01-	•
	125	RS	01-	•
	125	Schikra	99-	•



# Brake Pads

3027 ORGANIC  
4027 SINTERED  
6027 OFF ROAD

A 36,5 | L 93,9 | S 7,6

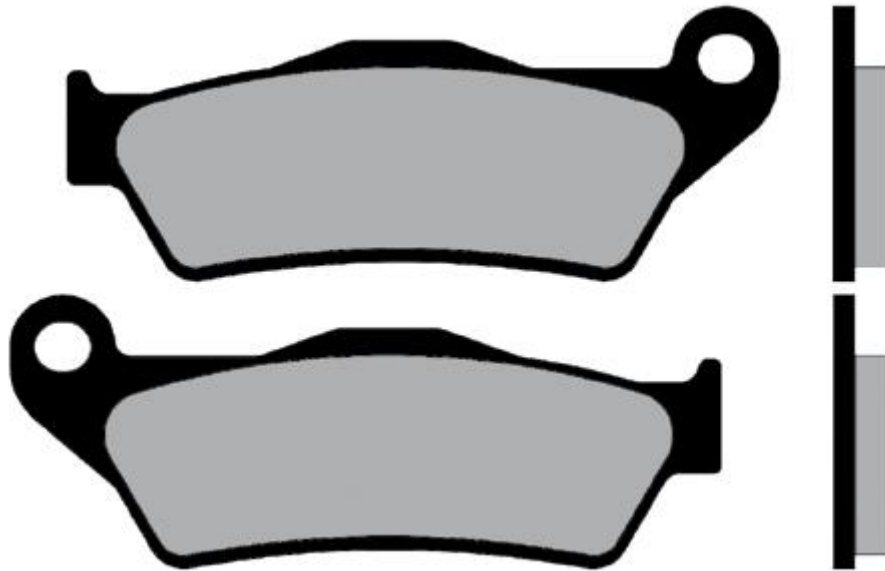

## ALFER

VRE	125	4-stroke	00-	•
VR	250	Cross	99-	•
VR	250	Enduro	99-	•
VR	250	No Limit	99-	•
VR	250	Supemotard	99-	•

## APRILIA

MX	125		04- 07	•
MX	125	Supemoto	07-	•
RX	125		97-	•
RX	125	Enduro	08-	•
RX	125	Supemotard	08-	•
SX	125		08- 13	•
SRV	850		12-	•
RST	1000	Futura	01- 03	•

## BENELLI







BX	449	Cross	07-	•
BX	505	Enduro	08-	•







## BIMOTA







DBX	1100		13-	•
-----	------	--	-----	---







## BMW







G	450	X	08- 10	•
	1200	HP2Enduro	04- 06	•
	1200	HP2Sport	08- 10	•
K	1200	GT (K44) With Integral ABS	04- 08	•
R	1200	Nine-T	14-	•
R	1200	Nine-T Pure	17-	•
R	1200	Nine-T Racer	17-	•
R	1200	Nine-T Scrambler	16-	•
R	1200	Nine-T UrbanGS	17-	•

					
K	1300	GT	09-10		•
<b>BREMO RACING CALIPERS</b>					
Floating Motocross					
Caliper 22.5930.62					
Off Road 122A99021, P2 24					
Off Road XQ21361, P2 28					
<b>CAGIVA</b>					
	750	Elefant	93-95		•
	900	Elefant	93-97	•	•
<b>CCM</b>					
	450	MX	08-10	•	
GP	450		16-	•	
604	600	RS	01	•	
604E	600	Sport	99-01	•	
604E	600	Supermoto	99-01	•	
C25	600		96-98	•	
	644	DS	02-06	•	
	644	R30	02-06	•	
<b>DUCATI</b>					
	620	Multistrada	05-06	•	
	695	Monster	07-12	•	
	800	Monster S2R	05-07	•	
	800	Monster S2R ABS	05-07	•	
	950	Multistrada	17-		•
	1200	Multistrada	15-		•
	1200	Multistrada S	15-		•
	1200	Multistrada S D-air	15-		•
	1200	Multistrada S Pikes Peak	16-		•
<b>FACTORY</b>					
YR	250		99-	•	
<b>GAS GAS</b>					
	50	WildHP	04-	•	•
EC	125		97-99	•	
	200	WildHP	08-		•
EC	200		99	•	
	240	WildHP	04-	•	•
	250	WildHP	08-	•	•
EC	250		97-99	•	
MC	250		97-99	•	
	300	WildHP	03-	•	•
EC	300		99	•	
	450	WildHP	03-	•	•
	515	WildHP	09-	•	•
<b>GILERA</b>					
	500	Nexus	04-	•	
GP	800		08-	•	
<b>HARLEY DAVIDSON</b>					
XG	500	Street	16-		•
XG	750	Street	16-		•
<b>HIGHLAND</b>					
	450	MX	06-	•	
	950	V2 Motard	00-	•	
	950	V2 Outback	99-	•	
<b>HONDA</b>					
NX	500	Dominator (Austria)	97-	•	
<b>HUSABERG</b>					
		all models	93-98	•	
TE	125		13	•	
FE	250		13	•	

					
TE	250		11-13	•	
TE	300		11-13	•	
FE	350		13	•	
FE	390		10-13	•	
FC	400		99-02	•	
FE	400	SE	99-03	•	
FC	450		03-08	•	
FE	450		09-13	•	
FE	450	e	04-08	•	
FX	450	e	03-08	•	
FC	470	e	01-02	•	
FX	470	e	01-02	•	
FC	501		99-01	•	
FE	501	SE	99-04	•	
FE	501		13	•	
FC	550		01-05	•	
FE	550	e	04-08	•	
FE	570		09-13	•	
FC	600		99-01	•	
FE	600	SE	99-02	•	
FE	650	e	01-08	•	
FX	650	e	01-05	•	
<b>HUSQVARNA</b>					
CR	125		96-13	•	
SM	125	S	09-13	•	
SM	125	S4T	11-13	•	
SM	125	125 Supermotard, S	99-13	•	
TC	125		14-	•	
TE	125		14-	•	
TE	125	4T	11-13	•	
WR	125		96-13	•	
WRE	125		96-13	•	
CR	250		96-05	•	
FC	250		14-	•	
FE	250		14-	•	
TC	250		02-13	•	
TC	250		14-	•	
TE	250		02-13	•	
TE	250		14-	•	
TE	250	4T	10-13	•	
WR	250		96-13	•	
TC	300		14-	•	
TE	300		14-	•	
WR	300		09-13	•	
TE	310	4T	10-13	•	
FC	350		14-	•	
FE	350		14-	•	
TE	350		96-13	•	
WR	360		98-13	•	
TE	400		01-13	•	
TE	410		96-13	•	
TC	449		11-13	•	
TE	449		11-13	•	
FC	450		14-	•	
FE	450		14-	•	
TC	450		02-10	•	
TE	450		02-10	•	
TE	450		14-	•	
FE	501		14-	•	

					
TC	510		02-10	•	
TE	510		02-10	•	
TE	510	Centennial	04-05	•	
TE	511		11-13	•	
TE	511		14-	•	
TC	570		01-13	•	
TE	570		01-13	•	
TC	610		96-13	•	
TE	610	Rallye	96-13	•	
TE	630		10-13	•	
TE	630		14-	•	
<b>KRAM-IT</b>					
GS	250		97-	•	
MX	250		97-	•	
SM	250		97-	•	
<b>KTM</b>					
		most models	94-	•	
	125	SuperMoto	00-	•	
EXC	125	Enduro	99-	•	
EXE	125		00-	•	
GS	125		92-97	•	
LC2	125		99-	•	
MX	125		92-93	•	
SX	125		96-	•	
SX	144		07-08	•	
SX	150		09-	•	
EXC	200	Enduro	99-	•	
SX	200		03-04	•	
EXC	250	Enduro	99-	•	
EXC	250	Enduro 4T	99-06	•	
EXC-F	250	Enduro	07-	•	
MX	250		92-93	•	
SX	250		96-	•	
SX-F	250		06-	•	
EXC	300		93-96	•	
EXC	300	Enduro	99-	•	
MX	300		92-	•	
EXC-F	350		11-	•	
SX-F	350		11-	•	
MX	360		96-97	•	
SX	360		96-97	•	
XC	360		96-97	•	
EXC	380	Enduro	99	•	
MX	380		98-	•	
SX	380		98-02	•	
XC	380		98-	•	
EXC	400	Racing	00-	•	
LC4	400		93-02	•	
LC4-E	400	Enduro	99-02	•	
SC	400		99-	•	
SX	400	Racing	00-02	•	
SXC	400	Tiainen Replica	99-00	•	
EXC	450	Racing	04-	•	
SX-F	450		03-	•	
XC-F	450		06-	•	
MX	500		92-93	•	
SX	505	Racing	07-	•	
XC-F	505		08-09	•	
EXC	520	Racing	00-02	•	

					
SX-F	520	Racing	00- 02	•	
XC	525	Racing	03-	•	
SX-F	525	Racing	03- 06	•	
EXC	530	Racing	08-	•	
SXC	540	Tiainen Replica	99- 00	•	
LC4	600	Six Days	92-	•	
LC4	620	Competition	99-	•	
LC4	620	Competition SuperMoto	00-	•	
LC4	620	RXC	95	•	
LC4	620	Supercompetition	01-	•	
SC	620		99-	•	
SX	620		95- 99	•	
LC4	625	SC Supermoto	02- 04	•	
SXC	625		03- 04	•	
LC4	640	Adventure	99- 04	•	
LC4-E	640	Enduro	99-	•	
LC4-E	640	Supermoto	99- 02	•	
LC4	660	Rallye	01- 03	•	
	950	R Superenduro	06- 08		•
	950	SM	05-		•
	950	SMR	07-		•
	990	Adventure R	10-		•
	990	Adventure, Adventure S, ABS	06- 11		•
	990	Supermoto	07- 11		•
	990	Supermoto R	10-		•
	990	Supermoto T	09-		•
	1050	Adventure	15-		•
	1090	Super Adventure	17-		•
	1090	Super Adventure R	17-		•
	1190	Adventure	13-		•
	1290	Super Adventure	15- 16		•
	1290	Super Adventure R	17-		•
	1290	Super Adventure S	17-		•
	1290	Super Adventure T	17-		•
<b>MAICO</b>					
	250	Motocross / Enduro	99-	•	
	500	Motocross / Enduro	99-	•	
	500	Supemotard	99-	•	
<b>MBK</b>					
XQ	125	Thunder	01-	•	
YP	125	Skyliner	99-	•	
	150	Skyliner	01-	•	
XQ	150	Thunder	02-	•	
	180	Skyliner	04-	•	
	300	Kilibre	03-	•	•
<b>MOTO-GUZZI</b>					
ES	1100	Quota	99-		•
V	1100	Breva, ABS	05- 07		•
	1200	Griso 8V	07-		•
	1200	Norge	06-		•
	1200	Norge GT 8V	10-		•
	1200	Sport	07- 08		•
	1200	Sport 8V	12-		•
	1200	Sport 8V SE	12-		•
	1200	Stelvio	08- 11		•
	1200	Stelvio 8V SE	12-		•
	1200	Stelvio NIX	09- 11		•
V	1200	Breva	08-		•
<b>MOTO-MORINI</b>					

					
	1200	Granferro	10-		•
	1200	Granpasso	08-		•
	1200	GT	10-		•
	1200	Scrambler	09-		•
<b>PIAGGIO</b>					
	500	X9 Evolution	04-		•
	500	X9 Evolution ABS	04-		•
<b>PRAGA</b>					
ED	250		99-		•
CD	610		99-		•
<b>RIEJU</b>					
MRX	250	Marathon	10-		•
MRX	450	Marathon	08-		•
<b>SHERCO</b>					
SE-R	125		17-		•
SE	250	R	14-		•
SE	250	2.5i Enduro	06- 11		•
SE	250	F, F-R	14-		•
SE	250	i/iR	12- 13		•
SE	250	i-F	13		•
SX	250	2.5i-F	09- 11		•
SCF-R	300		16-		•
SE	300	R	14-		•
SE	300	3.0i-F	10- 11		•
SE	300	F, F-R	14-		•
SE	300	i/iR	12- 13		•
SE	300	i-F	13		•
SE	450	4.5i Enduro	04- 11		•
SE	450	F, F-R	14-		•
SE	450	iR	12- 13		•
SE	510	5.1i Enduro	06- 11		•
SE	510	iR	12- 13		•
<b>SUZUKI</b>					
UH	125	Burgman	02- 06		•
UH	150	Burgman	04- 06		•
<b>SWM</b>					
RS	300	R	15-		•
RS	500	R	15-		•
<b>TM</b>					
	80	Cross	96- 00		•
	85		01- 12		•
	125		96-		•
	125	Enduro	01-		•
	250		01-		•
	250	E	95- 00		•
	250	Enduro	01-		•
	250	F	01-		•
	250	F Enduro	00		•
	250	F Enduro	01-		•
	300		98- 00		•
	300		01-		•
	300	Enduro	01-		•
	320		96- 97		•
	400	F	00- 01		•
	400	F Enduro	01		•
	450	F	02-		•
	450	F Enduro	02-		•
FT	450	Fi	17-		•
	530	F	01-		•



	530	F Enduro	01-	•
<b>VERTEMATI</b>				
C	500	Cross	02- 04	•
E	501	Enduro	02- 04	•
S	501	Supermotard	02- 04	•
<b>VOR</b>				
	400	Cross	00- 01	•
	400	Enduro	00- 01	•
EN	400		02-	•
MX	400		02	•
EN	450		02-	•
MX	450		02-	•
	500	492 Enduro	99	•
	500	495 Cross	99	•
EN	530		02-	•
MX	530		02-	•
<b>WRM</b>				
	450	MX	06-	•
<b>YAMAHA</b>				
XQ	125	Maxter	01-	•
YP	125	Majesty	01-	•
YP	125	R Majesty	99- 00	•
YZF	125	R	08- 13	•
XQ	150	Maxter	01-	•
YP	150	Majesty	01-	•
FZH	150	Fazer	11-	•
YP	180	R Majesty	03-	•
VP	300	Versity	03- 04	• •
VP	300	Versity	05- 06	• •
TT	600	E,S	96- 01	•
TT	600	R	93- 95	•
TT	600	R	98- 07	•
XT	660	Z Tenere	08- 14	•
XT	660	Z Tenere ABS	11- 14	•
<b>ZERO</b>				
FX		ZF2.8	15	•
FX		ZF5.7	15	•

# Brake Pads

3028 ORGANIC  
4028 SINTERED

A 50,7 | L 53,8 | S 8,0

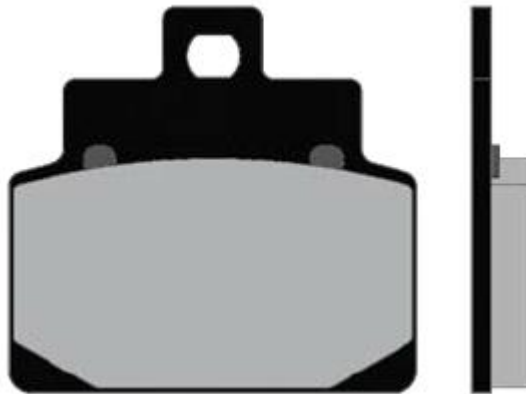

## APRILIA

	50	Scarabeo 4T	04-	•
	100	Scarabeo	00-	•
	100	Scarabeo 4T	03-	•
	100	Scarabeo Net	10-	•
	125	Habana/Custom	00- 02	•
	125	Leonardo	99-	• •
	125	Leonardo (Grimeca cal.)	99-	•
	125	Mojito, Mojito Custom	02- 12	•
SR	125		99- 03	•
	150	Leonardo	99-	• •
	150	Leonardo (Grimeca cal.)	99-	•
SR	150		00- 03	•
	250	Leonardo	99-	•
	300	Leonardo (Grimeca cal.)	05-	•

## PIAGGIO

	300	MP3LT iE ABS	14-	•
	300	MP3LT Sport ABS	14-	•
	500	MP3LT Touring Business ABS	14-	•
	500	MP3LT Touring Sport ABS	14-	•



# Brake Pads

3029 ORGANIC  
4029 SINTERED

A 56,3 | L 39,5 | S 7,0

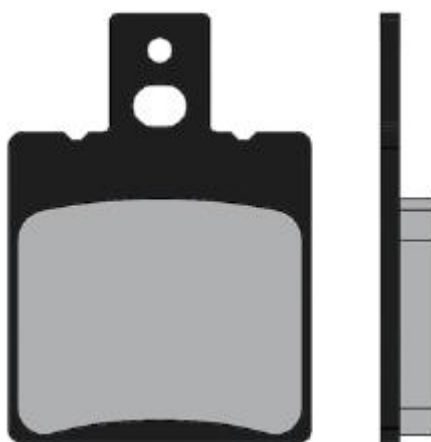

## A.P. RACING CALIPERS







CP-3548







### ALFER







MC	80		87-	•	
MC	125		87	•	
MC	125		88		•
GR	250	Enduro	85	•	
GR	250	Enduro	88		•
MC	250		85	•	
MC	250		87	•	•
MC	250		88		•
GR	300		85	•	
GR	300	Enduro	88		•







### APRILIA







	50	Tuono	04-		•
ET	50		85-	•	
RS	50		93- 95	•	•
RS	50		96- 99	•	
	50	Tuareg	85-	•	
	125	Classic	96-		•
	125	Red Rose	89-		•
	125	Sport Pro.	92		•
	125	Tuareg	87-		•
	125	Tuareg AS			•
	125	Tuareg Rally	89-		•
	125	Tuono	04- 07		•
AF1	125		87-		•
AF1	125	Europa, Futura	90- 92		•
AF1	125	Replica, Sintesi	89- 91		•
ETX	125	Tuareg	86- 87		•
RS	125	Extrema	93- 98		•







					
RS	125		99- 05		•
RS	125	Pista	05-		•
	200	Climber	93-	•	•
	250	Tuareg Rally	86-		•
MX	250	Cross	85	•	
RS	250		95- 02		•
RS	250	Pista	04-		•
RX	250		86-	•	
	350	Tuareg	86-		•
	350	Tuareg	88- 89		•
	350	Tuareg Wind	87- 88		•
ETX	350		- 86		•
ETX	350		86- 92		•
	600	Tuareg	86-		•
	600	Tuareg Wind	88		•
EIX	600		86- 92		•
<b>ARMSTRONG</b>					
MX	500		86-	•	
MX	600		86-	•	
<b>ASPES</b>					
	125	Sintesi	88-		•
ATK					
ATK	250	CC,MX	91- 92		•
ATK	350	FSCC,MX,SID	91- 92		•
ATK	350	GS	93-	•	•
ATK	406	CC,MX	91- 92		•
ATK	560		84- 88	•	
ATK	604	FSCC,MX,SID	91- 92		•
ATK	640		93-	•	•
<b>BENELLI</b>					
	124	T	83-	•	
	125	2CE	76- 78	•	
	125	Custom	85	•	
	125	Jarno	89		•
	125	Sport		•	
	125	T	76-	•	
	125	Velvet, Velvet Touring	99-		•
	150	Velvet, Velvet Touring	00-		•
	125	TT		•	
BX	125		89		•
BXK	125		88	•	
E	125	L.C.	85	•	
	250	2CE		•	
	250	Disc	76-	•	
	250	Velvet, Velvet Touring	99-		•
	304		83-	•	
	350	4T Turismo		•	
	354		78- 82	•	
	354	Sport	83-	•	•
	500	-4	76-	•	
	500	4T	- 76	•	
	654	Sport	83	•	•
	900	Tomado 3	00- 06		•
TnT	1100		04		•
<b>BETA</b>					
	50	Crono 502	97-	•	
	50	Quadra	97- 00	•	
	50	Tempo	97- 98	•	
KR	50		86- 87	•	







					
KR	50	Twin	88	•	•
ALP	240		96-		•
CR	250		83-	•	
ALP	260		96-		•
	500	GS,RV	84-	•	
<b>BIMOTA</b>					
		Furano	92-		•
1D		Tesi	93-		•
YB7	400		89		•
	500	Vdue	97- 00		•
	600	Bellaria	91-		•
YB9	600	SRI	97-		•
BB1	650	Supermono	97- 00		•
SB7	750		96-		•
YB4	750		89		•
1D	851	Tesi	91-		•
DB2	900		92- 00		•
DB3	900	Mantra	97- 00		•
DB4	900		99- 00		•
1D	906	Tesi	91-		•
2D	1000	Tesi	04- 06		•
SB8	1000	R	98- 00		•
SB8K	1000		06-		•
SB8K	1000	Santamonica	07-		•
YB11	1000		97-		•
YB6	1000		89		•
YB8	1000		90		•
	1002	Dieci	91-		•
DB7	1099	(Rad.cal)	09-		•
SB6	1100		97- 00		•
<b>BREMO RACING CALIPERS</b>					
Goldline 20.5161.42/51, road					
<b>CAGIVA</b>					
	50	Cocis	88-	•	
	50	Cucciolo	97-	•	
	50	Cocis	89	•	•
	50	Lucky Explorer	88-	•	
	50	Nuvola	00-	•	
	50	Prima	92-	•	•
	50	Super City	93-		•
	50	Supercity	92	•	•
	50	W4	92	•	•
	80	Cocis	91-	•	
	80	Super City	94-		•
	80	Supercity	92- 93	•	•
	80	W4	92-	•	•
LR	80		83-	•	
SST	80		83-	•	
SXI	80		83-	•	
	125	Aletta Electra	87-	•	
	125	Aletta Oro	86-	•	•
	125	Blues			•
	125	Blues	93-	•	•
	125	Cruiser	88-		•
	125	Cucciolo	00-	•	
	125	Dakar	86	•	
	125	Elefantre	87-	•	
	125	Enduro	86-	•	
	125	Freccia	89		•

						
	125	Freccia C 12 R		91-		•
	125	Mito		91-		•
	125	Nuvola		00-	•	
	125	Planet		97- 07		•
	125	Raptor		03- 10		•
	125	Supercity		92- 00		•
	125	Tamanaco		89		•
	125	W8		92- 95	•	•
K7	125			91-		•
N1	125			96-		•
WMX	125	GP-Replica		86-	•	
WRX	125				•	
	200	Elefant		86-	•	
MXR	250			82-	•	
SST	250	Ala Verde		81-	•	
WMX	250	GP		82	•	
	350	Alazurra		85-	•	•
	350	Elefant		86-		•
	350	W 12		92-		•
SST	350			83-	•	
SST	350	Ala Verde		81-	•	
SXT	350	Ala Rosa		82-	•	
T4	350	E		87-	•	
T4	350	R		87-	•	
MXR	400			82-	•	
	500	Mito		07		•
	500	River		00-		•
MXR	500			82-	•	
T4	500	E		87-	•	
WMX	500			85- 86	•	
WMX	500	Cross		87	•	•
SP	525	Mito		08- 10		•
	600	River		94- 99		•
	650	Alazurra			•	•
	650	Elefant		86-		•
	750	Elefant		88	•	•
	750	Lucky				
		Explorer		88		•
<b>CAN-AM</b>						
	200	ASE		86-	•	
	250	ASE		86-	•	
	250	MX LC		86-	•	
	350	ASE		86-	•	
	406	ASE		87-	•	
	500	ASE		86-	•	
	500	MX		86-	•	
	560	Sonic		86-	•	
<b>DB MOTORS</b>						
ZZ	50	Pirat		00-	•	•
ZZ	50	Sport		00-	•	
<b>DERBI</b>						
	50	Easy		96-	•	
	125	Mulhacen		07		•
	125	Terra		07		•
	250	RC		85	•	
<b>DUCATI</b>						
	350			75-	•	
	350	F3		86-	•	•
	350	GTV		77	•	•







						
	350	Indiana		86-		•
	350	Paso		86	•	•
	350	Sport		77-	•	•
	400	Monster (Japan)		01- 06		•
	400	SS, Junior		92- 97		•
	400	SS, Nuda		92-		•
	500	GTV		77-	•	•
	500	Pantah		85-	•	•
	500	Sport Desmo		77-	•	
	500	Twin GTL		75-	•	
	502	Single		93		•
	502	Supermono		93		•
	600	Monster		00- 01		•
	600	SL, TL Pantah		76-		•
	600	SS Supersport		95- 00		•
M	600	Monster		94- 99		•
	620	Monster Dark i.e.		02- 06		•
	620	Monster i.e., S i.e.		02- 06		•
	650	Indiana		86-		•
	695	Monster		07- 12		•
	748	S		99- 02		•
	748	Biposto		95- 98		•
	748	R		00- 02		•
	748	SP		95- 97		•
	748	SPS		98- 99		•
	750	Indiana				•
	750	Monster		96- 99		•
	750	Monster		00- 01		•
	750	Monster i.e.		02		•
	750	Paso		86	•	•
	750	Paso		87		•
	750	Paso		88	•	•
	750	SS Supersport		95- 99		•
	750	SS, Carenara		92-		•
	750	SS, Nuda		92		•
	750	Super Sport		92- 94		•
	800	Monster Dark i.e., s.i.e.		03- 07		•
	800	Monster i.e., s.i.e.		03- 07		•
	800	Monster S2R		05- 07		•
	800	Monster S2R ABS		05- 07		•
	851	Strada		89		•
	851	Superbike		90		•
	888	SPV		93		•
	888	SP4		92- 95		•
	888	SPO				•
	888	SPS		92- 95		•
	888	Strada		93		•
	888	Superbike		93		•
	900	FE		97-		•
	900	M, IL Monster		93- 99		•
	900	Monster		00- 01		•
	900	Monster i.e.		02		•
	900	SL		92- 97		•
	900	SS		90- 94		•
	900	SS Supersport		95- 97		•
	900	SSR		92		•
906	900	Paso		89		•
907	900	I. E.		90- 93		•
M	900	Street Monster		94- 99		•







					
MH	900		00-		•
	916	Biposto	94-		•
	916	Monster S4	01- 03		•
	916	SPS	97- 98		•
	996	SPS	99- 01		•
	996	Monster S4R	04-		•
	996	R	01		•
	998	S	02		•
	998	R	02		•
	1000	Monster Dark i.e., s.i.e.	03- 06		•
	1000	Monster i.e., s.i.e.	03- 06		•
<b>FANTIC</b>					
	50	Koala	88-	•	•
RC	50	Caballero	91-	•	•
RS	50	Caballero	91-	•	•
	250	Coach	91-	•	
<b>GARELLI</b>					
		Urka	91-	•	
	50	Tiger XLE	86-	•	•
GTA	125			•	•
GTA	125		83- 85	•	
XR	125	Tiger XRD	85	•	
<b>GILERA</b>					
SP		01	90		•
	50	Rally, R1		•	
	50	Sioux	92	•	•
RC	50	Top Rally	90	•	•
	125	Arizona Hawk	86-	•	
	125	Crono	92-		•
	125	Freestyle	92-		•
	125	HX, HE	83	•	
	125	KK, KR, KZ	86-		•
	125	MX1, MRX, SP01			•
	125	R1, R1S	90-		•
	125	SP02	90-		•
CX	125		91-		•
MXR	125		90		•
RX	125		83	•	
XR2	125		90		•
	200	Fast Bike			•
	200	RX	83	•	
RV	200				•
	250	Arizona Hawk	86-	•	
	250	Arizona Rally			•
	250	Arizona Rally	86-	•	
NGR	250		85-		•
	350	Saturno Bialbero			•
XRT	350		90-		•
	500	Saturno Bialbero	90		•
	500	Saturno Piuma	90-		•
	600	Nordwest	91-		•
RC	600		88		•
XRT	600		89		•
<b>HERCULES</b>					
ZX			86-	•	
<b>HUSQVARNA</b>					
CR	125		85- 90	•	
CX	125		84- 85	•	
	200	Prof	86-	•	•

					
CR	240		84- 85	•	
CR	250		85- 87	•	
CX	250		84- 85	•	
	400	Enduro	85-	•	
	430	Enduro	85-	•	
CR	500		86-	•	
CX/CR	500		84- 85	•	
TC	500		86-	•	
	504		83-	•	
TE	510		86- 87	•	
<b>ISR CALIPERS</b>					
		2 Piston (22-027/028/029)			
		4 Piston (22-025)			
<b>ITALJET</b>					
	350		83-	•	
<b>KEEWAY</b>					
	125	Enduro	07-		•
	125	X-Ray	07-		•
<b>KREIDLER</b>					
	125	Mustang	83-		•
<b>KTM</b>					
		Baja	86-	•	
		Country Baja	85	•	
	50	Comet PL, TS, RLW, RS, RS4L	86- 91	•	
GP	50	DXL, RS1		•	
GXE	50		87-	•	
MX	50		87-	•	
RSV	50		86-	•	
	80	RSL, L, RS, RL, Bora, Chopper	80-	•	•
PL	80	Watercooled		•	•
RLW	80		80-	•	•
MX	85		90	•	
LC	125		85	•	
LC	125		86-	•	•
MX	125		85	•	
MX	125		86	•	•
XC	125		85	•	
XC	125		86-	•	•
	250	Baja	86-	•	
LC	250		85	•	
LC	250		86	•	•
MC	250		83- 84	•	•
MX	250		83- 84	•	•
MX	250		85	•	
MX	250		86	•	•
XC	250		85	•	
XC	250		86- 89	•	•
XC	300		85	•	
XC	300		86- 90	•	•
	350	Country Cross	85-	•	
	350		83-	•	
GS4	350	500 K4	- 83	•	
K4	350	500 K4	- 83	•	
XC	350	MC	- 83	•	
	390	GS	83-	•	
XC	390	MC	- 83	•	
XC	420	MC	- 83	•	
MC	495	Leleu	82- 83	•	
MX	495	Leleu	82- 83	•	

											
GS	500	500 K4	Enduro	83-		•					
LC	500			85		•					
LC	500			86-		•				•	
MX	500			85		•					
MX	500			86-		•				•	
XC	500	MC		- 83		•					
4T	600	Enduro		84-		•					
GS	600			85		•					
XC	600	Cross		85		•					
XCE	600	Cross		85		•					
	620	Duke		96- 98						•	
	640	Duke		99- 02						•	
<b>LAVERDA</b>											
	50	Gaicho		92		•				•	
OR	50	Atlas		86		•				•	
OR	50	Atlas		90-		•				•	
	125	Custom		86-		•					
CU	125	Ride		86-		•					
LB	125	Uno		85-		•					
GS	350	Lesmo		86-		•				•	
PF	350	Alpino				•				•	
RS	350	Alpino				•				•	
	500	Alpino, S		77-		•				•	
OR	600	Atlas		86-						•	
	650			92-						•	
	668	668		96-						•	
	668	Ghost, Diamante		97-						•	
	750	Cup		98-						•	
	750	Diamante		97-						•	
	750	Ghost Strike		97-						•	
	750	S Formula		97- 01						•	
	750	S, S Carenata		97-						•	
	750	Sport		99-						•	
	750	Strike/Black Strike		99-						•	
	750	T8		98-						•	
	1000	IOTA		95						•	
<b>MAICO</b>											
GM	250	LC		85-		•					
MD	250			83-		•				•	
GM	500	LC		85-		•					
<b>MALAGUTI</b>											
	50	Enduro		85-		•					
MRX	50			89		•					
RST	50			90		•				•	
<b>MALANCA</b>											
	125	Mark		85-		•					
<b>MONTESA</b>											
	260	Evasion		92						•	
	309	Cota		89-						•	
	310	Cota		89-						•	
	311	Cota Trial		92						•	
<b>MOTO-GUZZI</b>											
		Ippogrifo		97-						•	
	125	Custom		85		•					
	125	Enduro TT		85		•					
BX	125			92		•				•	
	240	4		77-		•					
	250	TS		75- 76		•					
	350			77-		•				•	



						
	350	Falco		88	•	•
	350	Imola		78-	•	•
	350	Nevada		92-	•	
NIX	350			88	•	•
NIX	350			90-	•	
V35	350	C				•
V35	350	Florida				•
V35	350	GT			•	
V35	350	GT		90-		•
V35	350	II, Imola, Imola II		77	•	•
	400			79-	•	•
	500			77-	•	•
	500	Monza		78-	•	•
V50	500	1,2,3, Monza Chopper		77	•	•
	650			80-	•	•
	650	Florida			•	•
GT	650	Sessantacinque		89	•	•
NIX	650			90-	•	
V65	650	Lario		86-	•	•
V65	650	NIX		87-	•	•
V65	650	SP, Chopper			•	•
V65	650	TT		86-	•	•
	750	Nevada		92- 96	•	
	750	Nevada, Club/Base		97- 02	•	•
	750	Targa		89	•	•
NIX	750			89	•	•
RS	1000	Daytona		97- 00		•
V	1000	Strada		93-		•
V10	1000	Centauro		96- 00		•
	1100	Sport		96-		•
EV	1100	California		97- 00		•
EV	1100	California, 80, Touring		01-		•
V11	1100	Scura, Sport Scura		02-		•
V11	1100	Lemans Tenni, Lemans Rosso Corsa		01-		•
V11	1100	Sport		97- 00		•
V11	1100	Sport Rosso Mandell		01-		•
V11	1100	Sport, Sport Naked		01-		•
<b>MOTO-MORINI</b>						
XE	250	Country		88	•	
	350	Coguro				•
	350	Coguro, New York		90-		•
	350	Dart		88		•
	350	Dart		90-		•
	350	Indiana		88		•
	350	Kanguro		88		•
RLX	350	Excalibur		90-		•
	400	Dart		89-		•
	400	S			•	•
	500	Sei V Classic		89	•	
	501	Camel		88		•
	501	Coguro		89		•
	501	Excalibur		89		•
	501	New York		89		•
RLX	501	Excalibur		90-		•
	650	Indiana		88		•
	750	Indiana		88		•
<b>MZ</b>						
	660	(MUZ) Skorpion Cup		99-		•
	660	(MUZ) Skorpion Replica		97-		•

					
	660	(MUZ) Skorpion Sport	95-		•
	660	(MUZ) Skorpion Tour	95-		•
	660	(MUZ) Skorpion Traveller	99-		•
<b>OSSA</b>					
	500	Yanqee	78		•
<b>PGO</b>					
	50	G-Max Doppler	06-	•	
<b>PUCH</b>					
MAXI	80		88-		•
<b>REWACO</b>					
		FX4	07-	•	
		FX5	07-	•	
		FX6	07-	•	
		HS4	01-	•	
		HS5	01-	•	
		HS6	01-	•	
		RF1	07-	•	
<b>SACHS</b>					
SW	80	Lotus		•	
<b>SANGLAS</b>					
	400	Y	79- 80	•	•
	500	S2	79- 80	•	•
<b>SIMSON</b>					
	50	Spatz	99-	•	
	50	Sperber	99-	•	
	50	Star	99-	•	
	50	Habict CX	01-	•	
	80	IFA	89	•	
SR	80	-2 CE		•	
S	83	CX		•	
S	83	OR		•	
	125	Schikra	99-		•
<b>SWM</b>					
	125	GP	86-	•	•
	125	S1-S2		•	
	250	Explorer	86	•	•
	250	Pioner	86	•	•
	250	S1-S2		•	
TRL	329	MJ	86-	•	
<b>TORNAX</b>					
RX	80			•	
<b>YAMAHA</b>					
SZR	660		96- 01		•
<b>ZANELLA</b>					
	50	50 Racing Moped	92-	•	
RZA	125		92-	•	

# Brake Pads

3030 ORGANIC  
4030 SINTERED

A 50,8 | L 69,5 | S 8,0

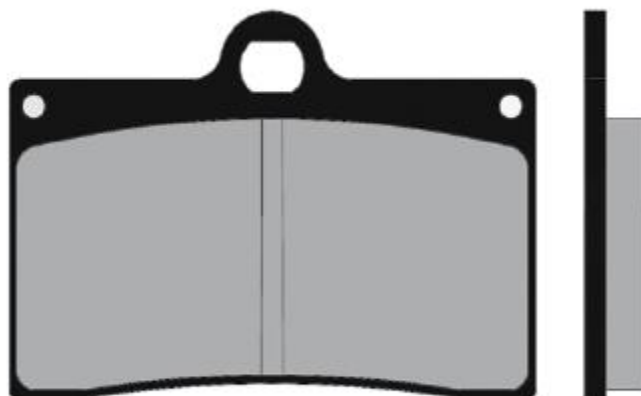

## APRILIA

RS-4	125	(I.Juan cal.)	11-	•
RS	250		95- 96	•

## BETA

	125	Jonathan	99-	•
	350	4.0Motard	04-	•
	350	Euro	99-	•
	350	Jonathan	02-	•
	350	M4 (Brembo cal.)	06-	•

## BIMOTA

		Furano	92-	•
1D		Tesi	93-	•
YB7	400		89	•
	500	Vdue	97- 00	•
	600	Bellaria	91-	•
YB9	600	SRI	97-	•
BB1	650	Supemono	97- 00	•
SB7	750		96-	•
YB4	750		89	•
1D	851	Tesi	91-	•
DB2	900		92- 00	•
DB3	900	Mantra	97- 00	•
1D	906	Tesi	91-	•
2D	1000	Tesi	04- 06	•
YB11	1000		97-	•
YB6	1000		89	•
YB8	1000		90	•
	1002	Dieci	91-	•
SB6	1100		97- 00	•

## BORILE

B	500	CRMT	02-	•
---	-----	------	-----	---

**BREMO RACING CALIPERS**

Billet 20.4756.52/62, racing

Goldline single pin 20.5165.55/65, road

**CAGIVA**

	125	Mito	93-	•
	125	Planet	97- 07	•
	125	Raptor	03- 10	•
	500	Mito	07	•
	500	River	00-	•
SP	525	Mito	08- 10	•
	600	River	94- 99	•

**CANNONDALE**

S	440		03	•
---	-----	--	----	---

**DUCATI**

	400	SS, Junior	92- 97	•
	400	SS, Nuda	92-	•
	502	Single	93	•
	502	Supermono	93	•
	600	SS Supersport	95- 00	•
M	600	Monster	94- 99	•
	748	Biposto	95- 98	•
	748	SP	95- 97	•
	750	Monster	96- 99	•
	750	SS	91-	•
	750	SS Supersport	95- 99	•
	750	SS, Carenara	92-	•
	750	SS, Nuda	92	•
	750	Super Sport	92- 94	•
	851	Strada	89	•
	851	Strada	91-	•
	851	Superbike	90	•
	888	Roche Replica	91-	•
	888	SPV	93	•
	888	SP4	92- 95	•
	888	SPO		•
	888	SPS	92- 95	•
	888	Strada	93	•
	888	Superbike	93	•
	900	FE	97-	•
	900	M, IL Monster	93- 99	•
	900	SL	92- 97	•
	900	SS	90- 94	•
	900	SS Supersport	95- 97	•
	900	SSR	92	•
907	900	I. E.	90- 93	•
M	900	Street Monster	94- 99	•
	916	Biposto	94-	•

**FANTIC**

TZ	125	SM	12-	•
----	-----	----	-----	---

**GAS GAS**

SM	125		02-	•
SM	250		02-	•
SM	400	FSE	02	•
SM	450	FSE	03- 06	•
SM	450	FSR	07-	•

**GILERA**

	350	Saturno Bialbero		•
	500	Saturno Bialbero	90	•
	500	Saturno Piuma	90-	•

**HONDA**

RS	125		95-	•
RS	250	R	93-	•

**HUSQVARNA**

SM	400	R	02	•
SM	450	R	03- 04	•
SM	570	R	01-	•

**INDIAN**

	1700	Chief Blackhawk	11- 13	•
	1700	Chief Bomber	10- 13	•
	1700	Chief Classic	10- 13	•
	1700	Chief Dark Horse	10- 13	•
	1700	Chief Deluxe	09- 13	•
	1700	Chief Roadmaster	09- 13	•
	1700	Chief Standard	09- 13	•
	1700	Chief Vintage	09- 13	•

**ITALJET**

	900	Grifon	00-	•
--	-----	--------	-----	---

**J. J. COBAS**

TRI			85	•
-----	--	--	----	---

**KTM**

	125	Sting	99-	•
SX	450	SM Factory Replica	04-	•
	600	Duke	93- 95	•
	620	Duke	96- 98	•
	640	Duke	99- 02	•
LC4	640	Supermoto	03	•
LC4	660	SM Factory Replica	02-	•
SMC	660	Supermoto	03	•

**LAVERDA**

	650		92-	•
	668		96-	•
	668	Ghost, Diamante	97-	•
	750	Cup	98-	•
	750	Diamante	97-	•
	750	Ghost Strike	97-	•
	750	S Formula	97- 01	•
	750	S, S Carenata	97-	•
	750	Sport	99-	•
	750	Strike/ Black Strike	99-	•
	750	T8	98-	•
TIS	800		99-	•
JOTA	1000		95	•

**MOTO-GUZZI**

		Ippogrifo	97-	•
	1000	Daytona	91-	•
	1000	Quota	92	•
RS	1000	Daytona	97- 00	•
V10	1000	Centaurio	96- 00	•
	1100	California Jackal	00	•
	1100	California Jackal Basic	00	•
	1100	California Special	99- 00	•
	1100	Sport	96-	•
EV	1100	California	97- 00	•
V11	1100	Sport	97- 00	•

**MZ**

	660	(MUZ) Skorpion Cup	99-	•
	660	(MUZ) Skorpion Replica	97-	•
	660	(MUZ) Skorpion Sport	95-	•



	660	(MUZ) Skorpion Tour	95-	•
	660	(MUZ) Skorpion Traveller	99-	•
<b>NORTON</b>				
	F-1		90	•
	TT		92-	•
<b>PGO</b>				
	250	G-Max	06-	•
<b>REVTECH</b>				
		Wilwood Caliper front/rear		
<b>SACHS</b>				
	125	X-Road	05-	•
XTC	125		99-	•
XTC-N	125		99-	•
	500	MadAss	05-	•
	650	Roadster V1.6	01-	•
	800	B-805	02-	•
	800	Roadster V2	00-	•
	800	S-805	03-	•
<b>TM</b>				
SMR	125		05-	•
SMF	400	F	02	•
SMR	400	F	03	•
SMR	450	F	04-	•
SMX	450	F	03	•
SMR	530	F	03-	•
SMX	600	F	03	•
<b>VOR</b>				
SM	400		02	•
SM	450		02-	•
	500	492 Super Motard	00- 01	•
SM	530		02-	•
<b>VOXAN</b>				
	1000	Cafe Racer	01- 06	•
	1000	Roadster	01- 06	•
<b>YAMAHA</b>				
TZR	250	R	94	•
SZR	660		96- 01	•

# Brake Pads

3031 ORGANIC  
4031 SINTERED

A 50,8 | L 67,6 | S 7,0

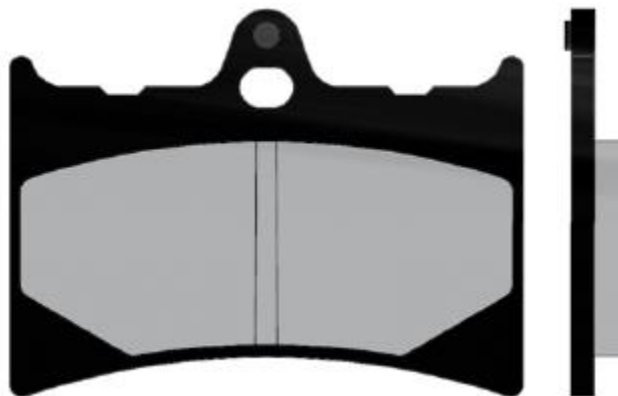

## ALFER

MC	125		88	•
GR	250	Enduro	88	•
MC	250		88	•
GR	300	Enduro	88	•

## APRILIA

	125	Sport Pro.	92	•
	125	Tuono	04- 07	•
AF1	125	Europa, Futura	90- 92	•
AF1	125	Replica, Sintesi	89- 91	•
RS	125	Extrema	93- 98	•
RS	125		99- 05	•
RS	125	Pista	05-	•
AF1	250	Replica	90-	•

## ASPES

	125	Sintesi	88-	•
--	-----	---------	-----	---

## ATK

ATK	250	CC,MX	91- 92	•
ATK	350	ESCC,MX,SID	91- 92	•
ATK	406	CC,MX	91- 92	•
ATK	560		89- 91	•
ATK	604		91-	•
ATK	604	ESCC,MX,SID	91- 92	•
ATK	604	Quad racer	90-	•

## BENELLI

	50	Devil	92	•
	50	Spring	92	•
	125	Jarno	89	•
BX	125		89	•

## GILERA

	125	SP01	90	•
--	-----	------	----	---



	125	Crono	92-	•	
	125	Freestyle	92-	•	
	125	MX1,MRX	90-	•	
	125	SP02	90-	•	
CX	125		91-	•	
	600	Nordwest	91-	•	
<b>KTM</b>					
MX	250	VC,Enduro	87-	•	•
EXC	350		87	•	•
GS	350		87	•	•
MX	350		87	•	•
	400	Enduro	87-	•	•
MX	500		87	•	•
LC4	550		87-	•	•
MX	550		87-	•	•
EXC	600		87	•	•
LC4	600		88-	•	•
LC4	600	Enduro	88-	•	•
MC	600		88	•	•
MX	600		87	•	•



# Brake Pads

3032 ORGANIC  
4032 SINTERED

A 27,9 | L 43,2 | S 5,0



## COBRA

CX	50	Big Wheel	10-	•	•
CX	50	Junior	07- 10	•	
CX	50	Junior	11-	•	•
CX	50	Senior	07-	•	•

## HUSQVARNA

CR	50	Pro Senior	06-		•
CR	50	Senior	06-		•
SM	50		10-		•
TC	50		17-	•	•

## KTM

SM	50	Supernoto	06-	•	•
SX	50	Pro Junior LC	02-	•	
SX	50	Pro Senior LC	02- 03	•	
SX	50	Pro Senior LC			
	50	LC	04-	•	•
SX	50	Senior Adventure	04-	•	
SX	65		04- 08		•

## LEM

	50	CX2, CX3, RX2, RX3	03-	•	•
	50	R2, R3, R3 XC	03-	•	•
RX	65		05-	•	•
RX	150		11-		•

## POLINI

X1	50	R	04-	•	•
X3	50	R	04-	•	•
X5	65	RP	05-	•	•

# Brake Pads

3033 ORGANIC  
4033 SINTERED

A 37,7 | L 30,8 | S 5,5

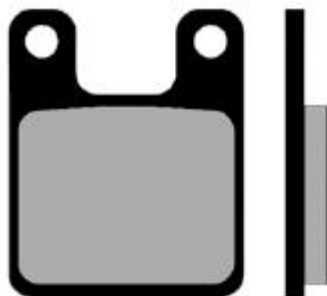

**POLINI**

50

Cross

99-

•

•

**RACING CALIPERS**

Minibike type CS Racing

•

Minibike type GRC

•

Minibike type Polini

•

# Brake Pads

3034 ORGANIC  
4034 SINTERED

A 42,6 | L 81,6 | S 9,3

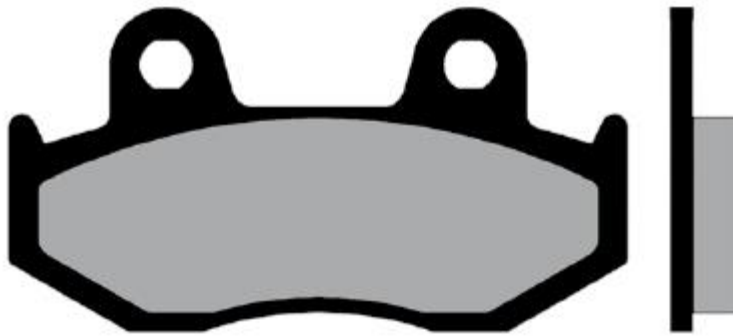

## HONDA

NHX	110		08- 09	•
SCV	110	Lead	08- 09	•
CH	125	Spacy	94-	•
PS	125	i	07- 13	•
SES	125	Dylan	02- 07	•
SH	125		02- 08	•
PS	150	i	07- 11	•
SES	150	Dylan	02- 06	•
SH	150		02- 08	•

## SUZUKI

	250	Sky Wave Type II	98-	•
AN	250	Burgman	98- 03	•
AN	400	Burgman	99- 00	•

## YAMAHA

YFZ	450	SLeft/Rear	06- 09	•
YFM	700	Raptor	13-	•

# Brake Pads

3035 ORGANIC  
4035 SINTERED

A 53,9 | L 50,9 | S 7,3

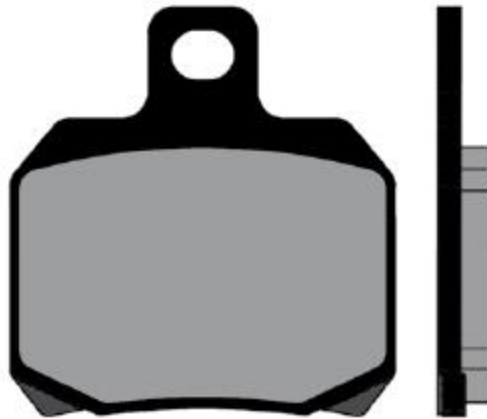













## APRILIA







RS	50		06-	•
	1000	Blue Marlin	02	•
ETV	1000	Caponord	01- 08	•
ETV	1000	Caponord Rally Raid	04- 08	•
RSV	1000	Factory Pista (Rad.cal)	04-	•
RSV	1000	Falco SL, R	00- 04	•
RSV	1000	Mille	97- 03	•
RSV	1000	Mille Nera (Rad.cal)	04-	•
RSV	1000	Mille R	00- 04	•
RSV	1000	Mille R (Rad.cal)	03	•
RSV	1000	Mille R (Rad.cal)	05-	•
RSV	1000	Mille R Factory (Rad.cal)	04-	•
RSV	1000	Mille SP	00	•
RSV	1000	Tuono Fighter	03- 05	•
RSV	1000	Tuono R	03	•
RSV	1000	Tuono R (Rad.cal) ABS	04-	•
RSV	1000	Tuono R Factory ABS	06-	•
RSV	1000	Tuono V4 R	11-	•
RSV4	1000	ABS	09-	•
RSV4-R	1000	ABS APRC	10-	•
RSV4-RF	1000		15-	•
RSV4-RR	1000		15-	•
RSV	1100	Tuono V4	15-	•
RSV	1100	Tuono V4 Factory	16-	•
RSV	1100	Tuono V4 RR	15-	•







## BENELLI

BN	302		14	•
	500	Leoncino	16-	•
TRK	502		16-	•
BN	600		12-	•







					
BN	600	GT	14-		•
	756	Cue	07-		•
	899	Trek	07-		•
TnT	899		07-		•
TnT	899	Century Racer	11-		•
	900	Tomado TRE	03- 06		•
	900	Tomado TRE RS (Rad.cal)	04- 06		•
TnT	1130		05-		•
TnT	1130	Cafe Racer	05-		•
TnT	1130	Century Racer	11-		•
TnT	1130	Officine	07-		•
TnT	1130	R	17-		•
TnT	1130	Sport	05-		•
TnT	1130	Titanium	05-		•
TnT	1130	Trek	06-		•
TnT	1130	Trek Amazonas	07-		•
<b>BIMOTA</b>					
3D	800	Tesi	16-		•
BB3	1000		14-		•
DB5	1000	Mille (Rad.cal)	05- 11		•
DB5	1000	S (Rad.cal)	07- 11		•
DB6	1000	Delirio (Rad.cal)	07-		•
DB10	1078	Bimotard	12-		•
DB5	1078	RE	12-		•
DB7	1098	(Rad.cal)	08		•
3D	1100	Tesi (Rad.cal)	07-		•
DB6R	1100	Delirio (Rad.cal)	08-		•
DB8	1198	(Rad.cal)	10-		•
	1200	Impeto	16-		•
DB11	1200	VLX (Rad.cal)	13-		•
DB12	1200		12-		•
DB9	1200	Brivido	12-		•
<b>BOMBARDIER</b>					
	500	Traxter 4x4	99- 00	•	•
<b>BRAMMO</b>					
		Empulse	14- 16		•
<b>BREMO RACING CALIPERS</b>					
		Goldline 20.6951.50, road			
		Supersport 120A44110, P2 34			
<b>CAGIVA</b>					
	650	Raptor	01-		•
	650	V-Raptor	01-		•
	1000	Raptor	00-		•
	1000	V-Raptor	00-		•
	1000	X3 Raptor	04-		•
	1000	X-Raptor	03-		•
	1000	Xtra Raptor	02-		•
<b>CPI</b>					
	50	GTR	03-	•	
	125	X-Large	02-	•	•
	200	X-Large	02-	•	•
<b>DERBI</b>					
GP1	50		05-	•	
GPR	50	Nude	04-	•	
GPR	50	Racing	04-	•	
	50	Senda DRD Pro SM	05-	•	
	125	Senda DRDSM	10-	•	
GP1	125		05-	•	
GP1	250		05-	•	

					
	659	Mulhacen	05- 07		•
	659	Mulhacen Cafe	08-		•
<b>DUCATI</b>					
	620	Multistrada	05- 06		•
	620	Multistrada Dark	05- 06		•
	620	Sport	03- 06		•
	696	Monster (Rad.cal)	08- 12		•
	749	S	03- 07		•
	749	R (Rad.cal)	04- 07		•
	750	Sport	00- 02		•
	750	Super Sport	00- 02		•
	795	Monster	12-		•
	796	Hypermotard ABS	10- 12		•
	796	Monster (Rad.cal)	11- 14		•
	796	Monster ABS (Rad.cal)	11- 14		•
	800	Hypermotard	13- 15		•
	800	Hypermotard ABS	13- 15		•
	800	Hypermotard SP	13- 15		•
	800	Hypermotard SP ABS	13- 15		•
	800	Hyperstrada	13- 15		•
	800	Hyperstrada ABS	13- 15		•
	800	Sport	03- 06		•
	800	Supersport	03- 06		•
	821	Monster	15-		•
	821	Monster Dark	15-		•
	848	Rad.cal)	08- 10		•
	848	EVO (Rad.cal)	11- 12		•
	848	Streetfighter	12-		•
	848	Streetfighter S	12-		•
	899	Panigale	14- 15		•
	900	Super Sport	98- 02		•
	916	Sport Touring 4	99- 01		•
	939	Hypermotard	16-		•
	939	Hypermotard SP	16-		•
	939	Hyperstrada	16-		•
	939	SuperSport	17-		•
	939	SuperSport S	17-		•
	944	Sport Touring	98-		•
	944	ST2	97-		•
	959	Panigale	16-		•
D16RR	990	Desmosedici RR	07- 08		•
	992	ST3	04-		•
	992	ST3s ABS	06-		•
	996	ST4s	02- 06		•
	996	ST4s ABS	03- 06		•
	998	Monster S4Rs	06		•
	999	S	03- 07		•
	999	Monster S4R	07-		•
	999	Monster S4RS	07-		•
	999	R (Rad.cal)	03- 07		•
	1000	Hypermotard	06		•
	1000	Monster S2R	06- 07		•
	1000	Multistrada	07-		•
	1000	Multistrada DS	03- 06		•
	1000	Multistrada SDS	05-		•
	1000	Supersport DS	03- 06		•
	1098	(Rad. cal)	07- 08		•
	1098	R (Rad.cal)	08-		•
	1098	R Bayliss LE (Rad.cal)	09-		•

					
1098	S (Rad. cal)		07- 08		•
1098	Streetfighter (Rad.cal)		09-		•
1098	Streetfighter S (Rad.cal)		09-		•
1100	Hypermotard		07-		•
1100	Hypermotard EVO		10-		•
1100	Hypermotard EVOSP		10-		•
1100	Monster (Rad.cal)		09-		•
1100	Monster ABS (Rad.cal)		09-		•
1100	Monster EVO (Rad.cal)		11-		•
1100	Monster EVO ABS (Rad.cal)		11-		•
1100	Monster S (Rad.cal)		09-		•
1100	Monster S ABS (Rad.cal)		09-		•
1100	Multistrada		07- 09		•
1100	Multistrada S		07- 09		•
1198	(Rad.cal)		09-		•
1198	S (Rad.cal)		09-		•
1198	SP (Rad.cal)		11-		•
1199	Panigale		12- 14		•
1199	Panigale R		13-		•
1199	Panigale S		12- 14		•
1199	Superleggera		14-		•
1200	Monster		14- 16		•
1200	Monster		17-		•
1200	Monster R		16-		•
1200	Monster S		14- 16		•
1200	Monster S		17-		•
1200	Multistrada		10- 14		•
1200	Multistrada SGT		12- 14		•
1200	Multistrada S Pikes Peak		11- 14		•
1200	Multistrada S Sport		10- 14		•
1200	Multistrada S Touring		10- 14		•
1299	Panigale		15-		•
1299	Panigale R		15-		•
1299	Panigale S		15-		•
1299	Panigale S Anniversario		17-		•
1299	Superleggera		17-		•
<b>GILERA</b>					
500	Nexus		04-		•
600	Supersport		02-		•
<b>HONDA</b>					
RC213V-S	1000		16-		•
<b>HOREX</b>					
VR6	1200	Cafe Racer	17-		•
VR6	1200	Classic	17-		•
<b>KAWASAKI</b>					
1000	H2 Carbon Ninja		17-		•
1000	H2 Ninja		15-		•
1000	H2R Ninja		15-		•
<b>KTM</b>					
RC8	1190		08-		•
RC8	1190	R	09-		•
RC8	1190	R Track	11-		•
1290	Super Duke GT		16-		•
1290	Super Duke R		14-		•
<b>LAVERDA</b>					
TIS	800		99-		•
SFC	1000	(Rad.cal)	04-		•
<b>MALAGUTI</b>					
125	Madison 3		08-		•

					
	250	Madison 3 ie	08-		•
GT	500	Spidemax	04-		•
RS	500	Spidemax	09-		•
<b>MBK</b>					
	125	Skycruiser	06-		•
XQ	125	Thunder	01-		•
YP	125	Skyliner	01-		•
	150	Skyliner	01-		•
XQ	150	Thunder	02-		•
	180	Skyliner	04-		•
<b>MONDIAL</b>					
	1000	EVO (Rad.cal)	04-		•
	1000	Piega	03-		•
	1000	RZNuda	04-		•
	1000	Starfighter (Rad.cal)	04-		•
<b>MOTO-GUZZI</b>					
	750	Breva	03-		•
	750	Nevada Classic ie	06-		•
	750	Nevada, Nevada Club	03-		•
V7	750	Cafe Classic	10-		•
V7	750	Classic	09- 12		•
V7	750	Clubman Racer	10-		•
V7	750	Racer	11		•
V	1100	Breva	04		•
	1200	MGS-01 Corsa (Rad.cal)	05-		•
	1200	Sport 4V	09- 11		•
<b>MOTO-MORINI</b>					
	1200	9 1/2	06- 09		•
	1200	Corsaro	06- 13		•
	1200	Sport	08-		•
<b>MV AGUSTA</b>					
	675	Brutale	12-		•
	675	F3	13-		•
	675	F3 RC	16-		•
	800	Brutale	13-		•
	800	Brutale Dragster	15-		•
	800	Brutale Dragster RC	17-		•
	800	Brutale Dragster RR	15-		•
	800	Brutale RR	15-		•
	800	F3 RC	16-		•
	800	Rivale	13-		•
	800	Stradale	15-		•
	800	Turismo Veloce	14-		•
	800	Turismo Veloce Lusso	14-		•
	800	Turismo Veloce RC	17-		•
<b>NORTON</b>					
	961	Commando Cafe Racer	11-		•
	961	Commando SE	10-		•
	961	Commando SF	13-		•
	961	Commando SF Sport	11-		•
<b>PEUGEOT</b>					
	50	CityStar	14-		•
	50	Speedfight 3 (LC)	10-		•
	50	Speedfight 3 RS (LC)	10-		•
	50	Speedfight 4 (LC)	15-		•
	125	Active	13-		•
	125	CityStar	11-		•
	125	Django Heritage	14-		•
	150	Django Heritage	14-		•



					
	200	CityStar	13-		•
	500	Satelis	06	•	•
<b>PIAGGIO</b>					
	125	X8	04		•
	125	X9	01- 03	•	•
	125	X9 Evolution Left/Rear	06-		•
	125	X9 Left/Rear	04-		•
	180	X9	02-	•	•
	200	X8	04		•
	200	X9	03-	•	•
	250	X9	00- 04	•	•
	500	Beverly Cruiser	08-	•	•
	500	X9	01- 03	•	•
	500	X9 Evolution	04-		•
	500	X9 Evolution ABS	04-		•
BV	500		06-	•	•
<b>RIEJU</b>					
MRT	50	Pro	09-	•	•
MRT	50	Pro Supermotard	09-	•	•
SMX	50	Pro	08-	•	
	50	Tango	08-	•	
	50	Tango	10-	•	
	125	Marathon Pro	09-	•	
	125	Marathon Pro Supermotard	09-	•	
	125	Tango	08-	•	
	125	Tango Pro	08-	•	
	250	Tango	08-	•	
<b>SUZUKI</b>					
UH	125	Burgman	02- 06		•
UH	150	Burgman	04- 06		•
<b>VICTORY</b>					
		Empulse TT	16-		•
<b>VOXAN</b>					
	1000	Cafe Racer	01- 06		•
	1000	Roadster	01- 06		•
VBI	1000	EVO	04-		•
<b>YAMAHA</b>					
VP	125	X-City	08-		•
XQ	125	Maxter	01-		•
YP	125	Majesty	01-		•
YP	125	X-Max	06-		•
YP	125	X-Max Sport Ed.	11-		•
XQ	150	Maxter	01-		•
YP	150	Majesty	01-		•
YP	180	RMajesty	04-		•

# 3036 ORGANIC

## Brake Pads

A 45,9 | L 55,3 | S 7,2

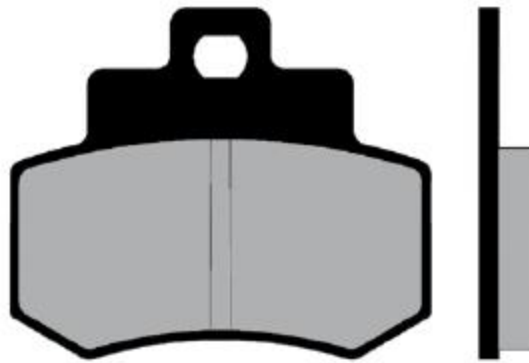

KYMCO

250

GrandDink

01-

•

# 3037 ORGANIC

## Brake Pads

A 50,8 | L 44,8 | S 6,9

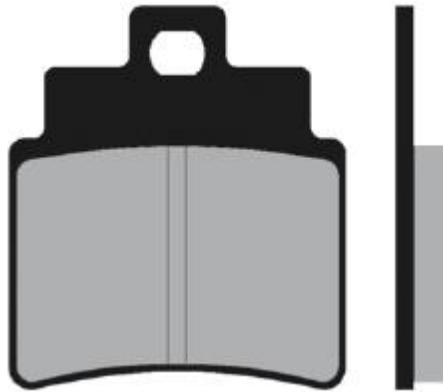

### ARCTIC CAT

	250	DVX	06- 09	•
	300	DVX	09-	•

### GILERA

	250	OregonQuad	07-	•
--	-----	------------	-----	---

### KYMCO

	250	GrandDink	01-	•
	250	MXU	06-	•
	250	UrbanQuad	06-	•

### KXR

	250		04-	•
	300	Maxxer	06-	•
	300	Maxxer Supermoto	15-	•

### SYM

	125	Voyager	05-	•
	250	Joymax	07-	•
	250	Voyager	05-	•

# 3038 ORGANIC

## Brake Pads

A 42,0 | L 89,5 | S 9,5

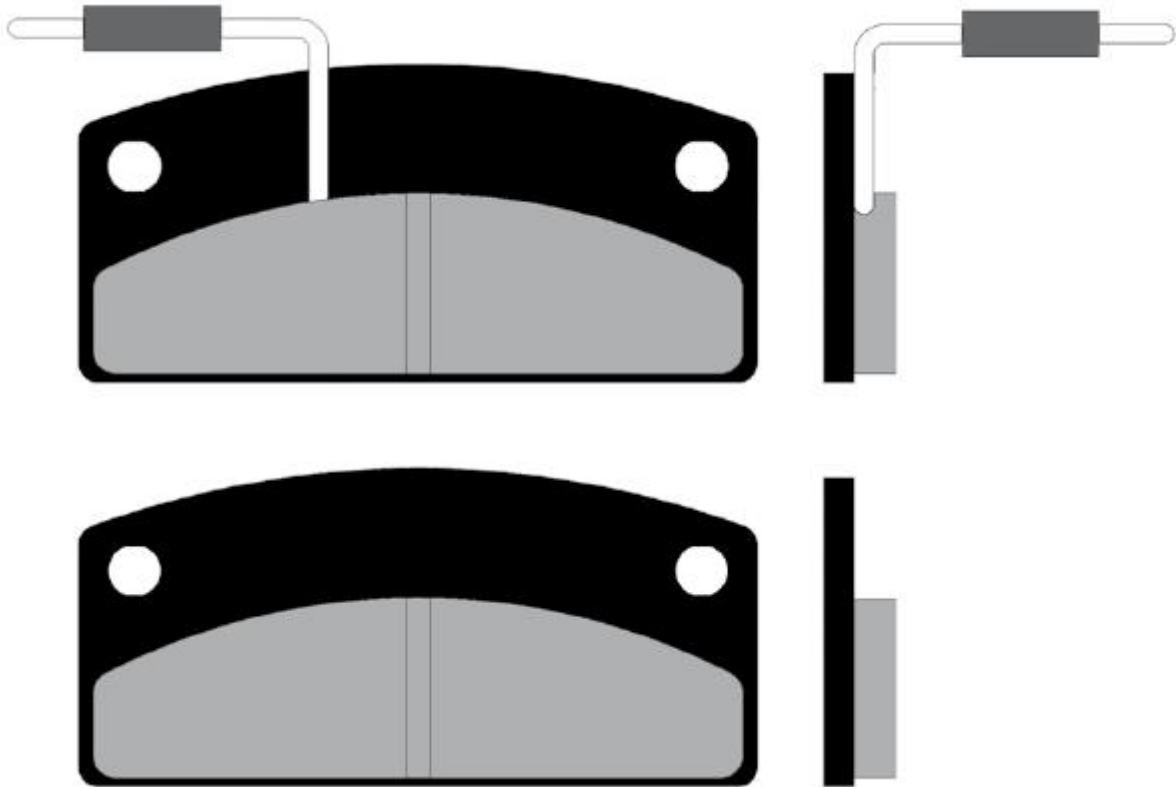

### MICROCAR

500	Microcar	•
505	Greav Eike	•



# 3040 ORGANIC

## Brake Pads

A 43,7 | L 49,7 | S 6,0

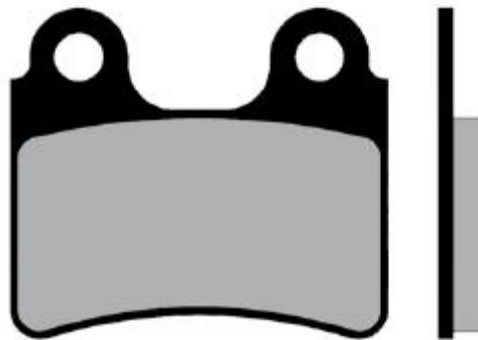

### AJP







PR3	125	Enduro	08- 12	•
PR3	125	Supemotard	08- 12	•
PR4	125	Enduro	04-	•
PR4	125	Supemotard	04-	•
PR3	200	Enduro	08- 12	•
PR3	200	Supemotard	08- 12	•
PR4	200	Enduro	04-	•
PR4	200	Supemotard	04-	•

### BETA

	80	EVO	09-	•
	80	Rev	08-	•
	125	EVO	09-	•
	125	Rev 3	00- 05	• •
	125	Rev 3	06-	•
	200	EVO	09-	•
	200	Rev 3	06-	•
	250	4-T Rev 3	07-	•
	250	EVO (2-T / 4-T)	09-	•
	250	Rev 3	00- 04	• •
	250	Rev 3	05-	•
	270	Rev 3	00- 04	• •
	270	Rev 3	05-	•
	290	EVO	09-	•
	300	EVO	09-	•

### GAS GAS

TX	125	Randone	12-	•
TXI	125		04-	•
TXI	200		04-	•
TXI	250		04-	•
TXI	280		04-	•

					
TXT	300		04-	•	
TXT	300	Pro	07-	•	
<b>HONDA</b>					
	250	Cota 4RT	05- 13	•	
	260	Cota 4RT	14-	•	
<b>MONTESA</b>					
	250	Cota 4RT	05- 13	•	
	260	Cota 4RT	14-	•	
	360	315R	01- 04	•	
<b>OSSA</b>					
IR	125	i	15-	•	
IR	250	i	15-	•	
IR	280	i	10-	•	
IR	280	i Explorer	12-	•	
IR	300	i	15-	•	
<b>SCORPA</b>					
SY	115	F Trial	06-	•	
	125	Twenty Trial	16-	•	
SY	125	F Trial	06-	•	
	250	Twenty Trial	16-	•	
SY	250	F Trial	06-	•	
SY	250	Trial	00-	•	
	300	Twenty Trial	16-	•	
<b>SHERCO</b>					
ST	125	1,25	06-	•	
ST	250	2,5	01-	•	
ST	290	2,9	01-	•	
ST	300		16-	•	
ST	320	3.2F	05-	•	
<b>TRS</b>					
	250	ONE	16-	•	
	280	ONE	16-	•	
	300	ONE	16-	•	

# Brake Pads

3041 ORGANIC  
4041 SINTERED

A 41,2 | L 96,8 | S 9,0  
A 41,2 | L 77,0 | S 9,0

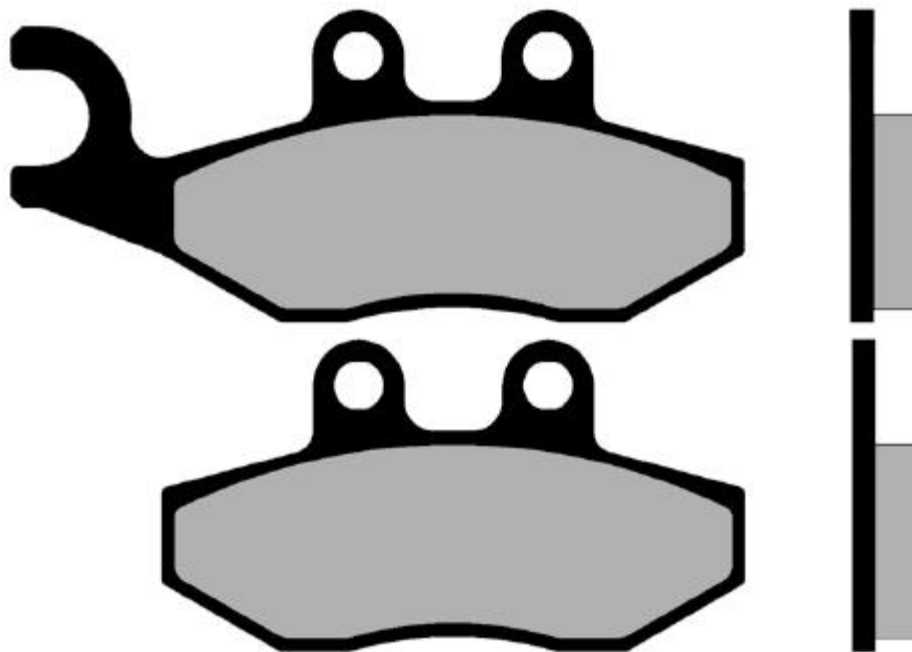

## APRILIA

	50	Sport City One	08-	•	
SR	125	Max	12-	•	•
SR	125	Sport City One	12-	•	
SR	300	Max	12-	•	•
SRV	850		12-		•

## DERBI

	50	Boulevard	09-	•	
--	----	-----------	-----	---	--







## GILERA

	50	Runner PJ	06-	•	
	50	Runner SP	06-	•	
	125	Nexus	07-	•	•
FX	125	Runner (Hengtong cal.)	00-	•	
FX	125	Runner SP (Hengtong cal.)	00-	•	
ST	125	Runner	08-	•	
VX	125	Runner 4T (Hengtong cal.)	01-	•	
FXR	180	Runner (Hengtong cal.)	00-	•	
FXR	180	Runner SP (Hengtong cal.)	00-	•	
VXR	180	Runner	01-	•	
VXR	180	Runner 4T (Hengtong cal.)	01-	•	
ST	200	Runner	08-	•	
VXR	200	Runner 4T (Hengtong cal.)	01-	•	
	250	Nexus	07-	•	•
GP	800		08-		•

## PEUGEOT

	50	CityStar	14-	•	
	125	Active	13-	•	



						
	125	CityStar		11-	•	
	125	Geopolis		06-	•	
RS	125	Geopolis		10-	•	
	200	CityStar		13-	•	
	250	Geopolis		06-	•	•
	250	Satelis		06-	•	•
<b>PIAGGIO</b>						
	50	Fly		05-	•	
	50	Primavera		14-	•	
	50	Sprint		15-	•	
TPH	50	2T		11-	•	
	100	Fly		07-	•	
	100	Zip		07-	•	
	125	946		14-	•	
	125	Beverly		02- 03	•	•
	125	Camaby		08-	•	•
	125	Fly		05-	•	
	125	Primavera		14-	•	
	125	Primavera 70		16-	•	
	125	Sprint		16-	•	
	125	Sprint S		17-	•	
	125	Sprint Sport		17-	•	
	125	X10 Executive Left/Rear		13-	•	
	125	X7		08-	•	
	125	X8		04-	•	
	125	X9 Evolution Left/Rear		06-	•	
	125	X9 Left/Rear		04-	•	
	125	Xevo		08-	•	
GT	125	L		04-	•	
GIS	125			07-	•	
GIS	125	Super		10- 13	•	
GIS	125	Super i.e.		15-	•	
GIS	125	Supersport		13	•	
GTV	125			08-	•	
GIX	125	SuperHexagon (Hengtong cal.) (11" wheels)		00-	•	
GIX	125	SuperHexagon (Hengtong cal.) (12" wheels)		01-	•	
	150	Fly		06-	•	
	150	Primavera		14-	•	
	150	X8 Street		06-	•	
GIX	180	SuperHexagon (Hengtong cal.) (11" wheels)		00-	•	
GIX	180	SuperHexagon (Hengtong cal.) (12" wheels)		01-	•	
	200	Beverly		02-	•	•
	200	Camaby		08-	•	•
	200	X8		04-	•	
BV	200			02- 04	•	•
BV	200			05-	•	
GT	200	L		04-	•	
	250	Beverly		07-	•	•
	250	GT 60		06-	•	
	250	X7		08-	•	
	250	X8		06-	•	
	250	X9 Left/Rear		05-	•	
	250	Xevo		08-	•	
BV	250			06-	•	•
GIS	250	ABS		06-	•	
GTV	250			08-	•	
	300	Beverly i.e.		11-	•	
	300	Beverly Tourer		07-	•	•
	300	Camaby Cruiser		10-	•	•



	300	X7 Evo i.e.	11-	•	
GTS	300	i.e.	12-	•	
GTS	300	Super	09-	•	
GTS	300	Super Sport i.e.	11-	•	
GTS	300	Touring ABS	17-	•	
GTS	300	Touring i.e.	11- 12	•	
GTV	300	i.e.	11-	•	
	350	Beverly S	14-	•	
	350	Beverly Sport Touring ie ABS	12-	•	
	350	X10 Executive Left/Rear	13-	•	
BV	350		12-	•	
	400	MP3 iE	07- 10		•
	400	MP3 LT iE	09- 10		•
	400	MP3 LT Touring	11- 12		•
	400	MP3 Touring	11- 12		•
	400	X8 Left/Rear	07-	•	•
	400	Xevo Left/Rear	08-	•	•
	500	MP3	10-		•
	500	MP3 LT Touring Business	11- 13		•
	500	MP3 LT Touring Business ABS	14-		•
	500	MP3 LT Touring Sport	11- 13		•
	500	MP3 LT Touring Sport ABS	14-		•
	500	MP3 Touring Business	11- 12		•
	500	MP3 Touring Sport	11- 12		•
	500	X10 Executive Left/Rear	13-	•	

# Brake Pads

3042 ORGANIC  
4042 SINTERED

A 39,0 | L 35,8 | S 6,0



## APRILIA

50	RX	04-	•
----	----	-----	---

## BETA

50	ProRace 12/10	04-	•	•
----	---------------	-----	---	---

## FACTORY

R12	50	Phantom Agua	06-	•
R14	50	Phantom Agua	04-	•
R2	65	Phantom	04-	•

## GAS GAS

TX	125	Randone	12-	•
TXI	125	(Formula cal.)	12-	•
TXI	125		04-	•
TXI	125	Pro Racing	14-	•
TXI	125	Pro Replica	13-	•
TXI	200		04-	•
TXI	250	(Formula cal.)	12-	•
TXI	250		04-	•
TXI	250	Pro Racing	14-	•
TXI	250	Pro Replica	13-	•
TXI	280	(Formula cal.)	12-	•
TXI	280		04-	•
TXI	280	Pro Racing	14-	•
TXI	280	Pro Replica	13-	•
TXI	300	(Formula cal.)	12-	•
TXI	300		04-	•
TXI	300	Pro	07-	•
TXI	300	Pro Racing	14-	•
TXI	300	Pro Replica	13-	•

## HONDA

	250	Cota 4RT	05- 13	•
Cota	260	4Ride	16-	•
Cota	260	4RT	14-	•
Cota	260	4RT Race Replica	15-	•
Cota	300	RR	16-	•

**HUSQVARNA**

CR	50	Junior	06-	•
CR	50	Pro Senior	06-	•
CR	50	Senior	06-	•
SM	50		10-	•

**JOTAGAS**

JT	125		14-	•
JT	250		14-	•
JT	280		14-	•
JT	300		14-	•

**MACBOR**

XC	50	510 Racing	04-	•
XC	50	512 Pro	04-	•
XC	50	512 Racing	04-	•
XC	50	512 T	04-	•
XC	50	515 R 6V	04-	•

**MONTESA**

	250	Cota 4RT	05- 13	•
Cota	260	4Ride	16-	•
Cota	260	4RT	14-	•
Cota	260	4RT Race Replica	15-	•
Cota	300	RR	16-	•
	360	315R	01- 04	•

**OSSA**

TR	125	i	15-	•
TR	250	i	15-	•
TR	280	i	10-	•
TR	280	i Explorer	12-	•
TR	300	Factory R	15-	•
TR	300	i	15-	•

**SCORPA**

SY	115	F Trial	06-	•
TYS	115	F Trial	06-	•
	125	Twenty Trial	16-	•
SY	125	F Trial	06-	•
TYS	125	F Trial	06-	•
	250	Twenty Trial	16-	•
SY	250	F Trial	06-	•
SY	250	Trial	00-	•
	300	Twenty Trial	16-	•

**SHERCO**

ST	80	(Formula cal.)	13- 14	•
ST	125	(Formula cal.)	13- 14	•
ST	125	1,25	06-	•
ST	250	(Formula cal.)	13- 14	•
ST	250	2,5	01-	•
ST	290	(Formula cal.)	13- 14	•
ST	290	2,9	01-	•
ST	300		16-	•
ST	305	(Formula cal.)	13- 14	•
ST	320	3.2F	05-	•

**TRS**

	250	ONE	16-	•
	280	ONE	16-	•
	300	ONE	16-	•

**VERTIGO**

	300	Combat Camo Works	15-	•
	300	Combat Ice Hell	15-	•
	300	Combat RR	15-	•

# 3043 ORGANIC

Brake Pads

A 42,0 | L 94,5 | S 7,2  
 A 42,0 | L 77,0 | S 7,2

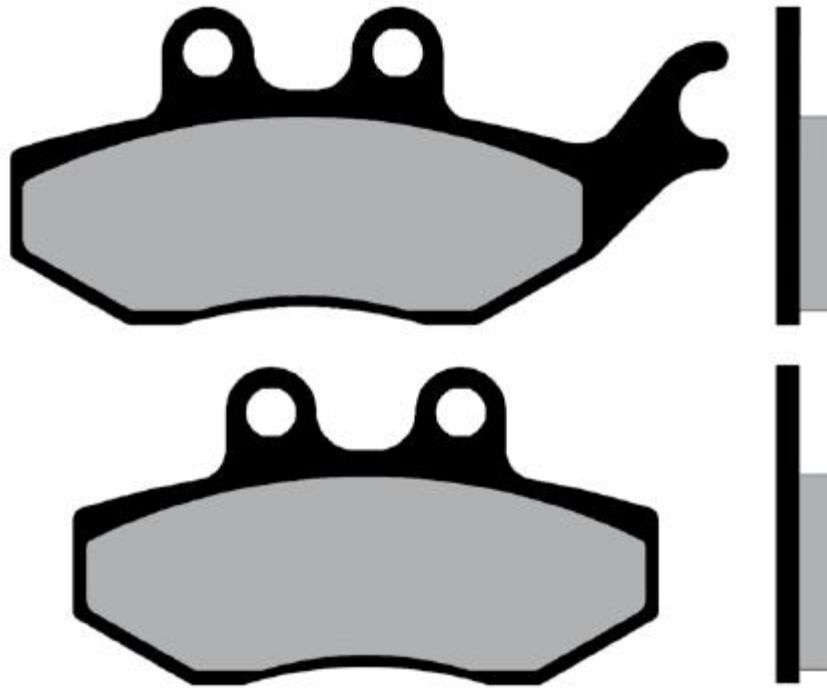

**ITALJET**

250	Jupiter	01-	•
-----	---------	-----	---

**KEEWAY**

IX	SM	10-	•
----	----	-----	---

**RIEJU**

NKD		04- 07	•
RS2	Matrix	03-	•
RS3		12-	•

# Brake Pads

3046 ORGANIC  
4046 SINTERED  
6046 OFF ROAD

A 44,0 | L 60,1 | S 9,5



## BRAKING

Rear cross (1 piston)

### FANTIC

50	Caballero Motard	10-	•
50	Caballero Regularita	10-	•
125	Caballero Enduro 2T	12-	•
125	Caballero Motard 2T	10-	•
125	Caballero Motard 4T	10-	•
125	Caballero Regularita 4T	10-	•
200	Caballero Motard 4T	10-	•
200	Caballero Regularita 4T	10-	•
250	Enduro 4T	16-	•

### HM

CR	125	Supermotard	04- 06	•
CRE	125	Enduro	02- 06	•
CRM	125	XSupermotard	07	•
CRE	250	Enduro	02- 03	•
CRE	250	FEnduro	04- 13	•
CRE	250	Supermotard	04- 07	•
CRE	250	XEnduro	04- 13	•
CRF	250	Supermotard	04- 06	•
CRM	250	XSupermotard	07- 13	•
CRE	450	FEnduro	02- 13	•
CRE	450	XEnduro	04- 13	•
CRF	450	450	02- 06	•
CRM	450	450 Supermotard	07- 13	•
CRM	500	XSupermotard	07- 13	•

### HONDA

CR	125	R	02- 07	•
CRE	125		02- 07	•
CRE	125	RR	11-	•



CRF	150	R	07-	•
CR	250	R	02- 07	•
CRE	250		02- 07	•
CRE	250	F	04-	•
CRF	250	R	04- 09	•
CRF	250	R Efi	10-	•
CRF	250	X	04-	•
CRE	450	F	02-	•
CRF	450	Efi	09- 12	•
CRF	450	R	02- 08	•
CRF	450	R Efi	13- 16	•
CRF	450	R Efi	17-	•
CRF	450	RX Efi	17-	•
CRF	450	X	05-	•
<b>MEGELLI</b>				
	125	M, R, S	08-	•
<b>SUZUKI</b>				
RME	50		10-	•
<b>TM</b>				
	85		13-	• •

# Brake Pads

3047 ORGANIC  
4047 SINTERED

A 42,6 | L 81,6 | S 8,2

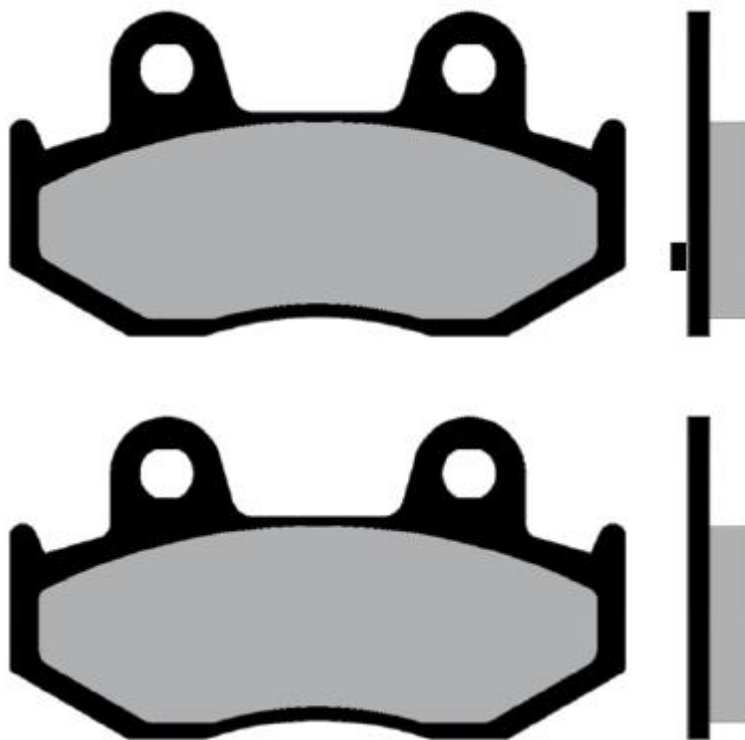

## KAWASAKI

SC	250	Epsilon	02-	•
----	-----	---------	-----	---

## SUZUKI

AN	250	Burgman	04-06	•
AN	400	Burgman	01-06	•



# 3048 ORGANIC

## Brake Pads

A 47,2 | L 50,0 | S 7,0

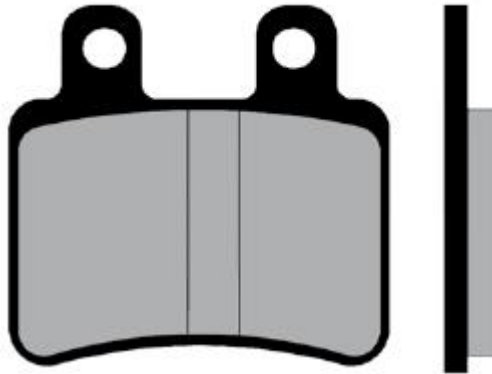

### DERBI

50	Senda DRD Pro SM	05-	•
125	Boulevard	03-	•
125	Senda Baja	06-	•
150	Boulevard	03-	•

### ITALJET

50	Jet-Set	02-	•
100	Millennium 2T	01-	•
125	Jet-Set	02-	•
125	Millennium	00-	•
150	Jet-Set	02-	•
150	Millennium	00-	•

### PEUGEOT

50	Elystar	03-	•
125	Elyseo	00-	•
125	Elystar	03-	•
125	Geopolis	06-	•
125	Jet-Force Compressor	03-	•
125	Looxor	03-	•
125	Satelis	04-	•
125	Satelis ABS	04-	•

RS	125	Geopolis	10-	•
	150	Elyseo	00-	•
	150	Elystar	03-	•
	400	Geopolis (AJP cal.)	07-	•
	600	Satelis ABS	04-	•

### RIEJU

RS2	50	Matrix	03-	•
-----	----	--------	-----	---

### SCORPA

	250	T-Ride	08-	•
--	-----	--------	-----	---

**SHERCO**

SE	50	Enduro	07-	•
SM	50	Supemotard	07-	•
SE	125	1.25F	10-	•

**YAMAHA**

DT	50	R	04-	•
DT	50	XSupemotard	04-	•
XT	125	R	05-	•

# 3049 ORGANIC

Brake Pads

A 36,8 | L 64,0 | S 10,5  
A 43,2 | L 85,2 | S 8,2

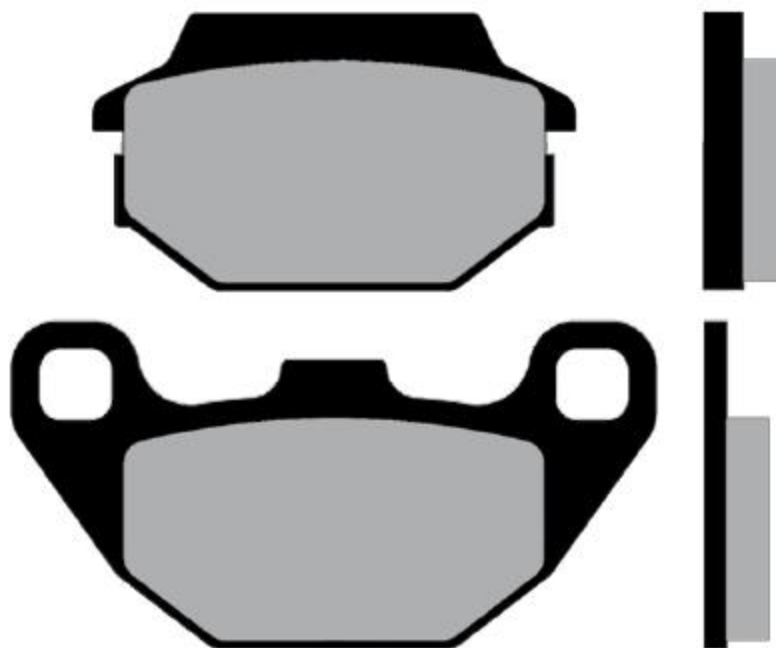

## KYMCO

	50	Agility (4T) R16	06-	•
	50	MXer	03-	•
	50	MXU	05-	•
	50	People	99-	•
	50	Super-8	08-	•
	50	Super-9L/C	02-	•
	125	Agility 16+	14-	•
	125	MXer	03-	•
	125	People	01-	•
	125	People One i	14-	•
	125	Super-8	08-	•
	125	Super-9	00-	•
S	125	People	05-	•
	150	MXer	03-	•
	150	MXU	05-	•
	150	People	01-	•
	200	Agility 16+	14-	•
	200	Agility R16	11-	•
S	200	People	05-	•
	250	Super-9	00-	•

## LAVERDA

	125	Phoenix	01-	•
	150	Phoenix	01-	•
	200	Phoenix	01-	•

## SYM

	125	Joyride	01- 06	•
--	-----	---------	--------	---



HD	125			04-	•	
	150	Joyride		01-		•
	200	Joyride		01-		•
HD	200			04-	•	
	500	GT		07-		•

# Brake Pads

3050 ORGANIC

4050 SINTERED

6050 SINTERED

A 34,2 | L 94,0 | S 7,5

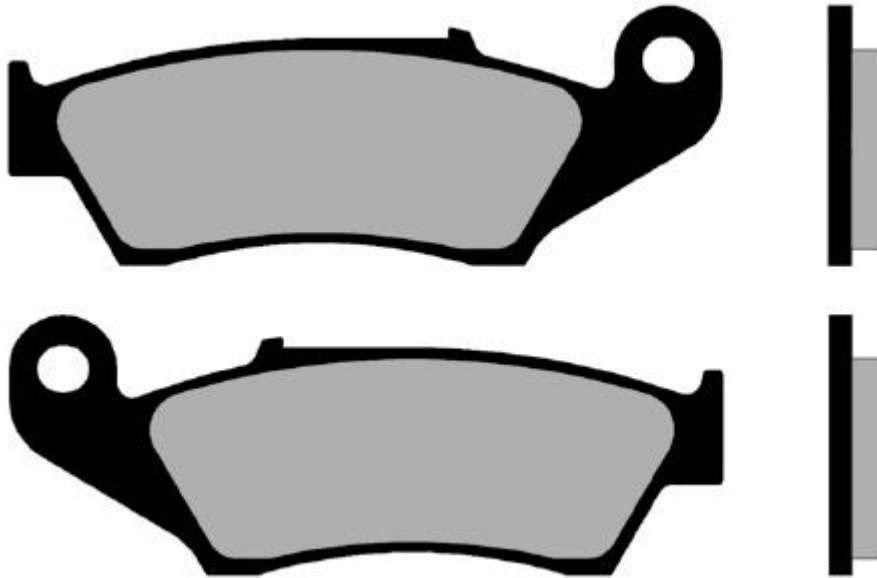

## AJP

PR5	250	Enduro	09	•
PR5	250	Supemotard	09	•

## APRILIA

MXV	450		09-	•
RXV	450		06-	•
RXV	550		06-	•

## BETA

RR	250		05-	•
	300	Crosstrainer	15-	•
RR	300		13-	•
RR	350	Efi	15-	•
RR	350	Efi Racing	15-	•
RR	350	Enduro	12- 14	•
RR	390		15-	•
RR	400	Enduro	05-	•
RR	430		15-	•
RR	430	Racing	15-	•
RR	450	CrossCountry	12-	•
RR	450	Enduro	05-	•
RR	480		15-	•
RR	480	Enduro	15-	•
RR	498	Enduro	12-	•
RR	525	Enduro	05-	•

## BIMOTA

BBX	300	Enduro	12-	•
BBX	508	Enduro	12-	•

## BRAKING

Front cross

**CANNONDALE**

MX	400		00-03	•
C	440	R	03	•
E	440	A, R	03	•
X	440		03	•

**CPI**

	125	Sahel	02-	•
--	-----	-------	-----	---

**FANTIC**

	50	Regolama Competizione	08-	•
MX	50	Regolama Competizione	08-	•
MX	65	Regolama Competizione	08-	•
	80	Regolama Competizione	08-	•
MX	85	Regolama Competizione	08-	•
	125	Caballero Enduro 2T	12-	•
	125	Caballero Motard 2T	10-	•
	125	Regolama Competizione	08-	•

**GAS GAS**

	125	Enducross	93-	•
EC	125		00-	•
MC	125		03-	•
EC	200		00-	•
EC	200		17-	•
EC	200	Hobby	07-16	•
EC	250		00-16	•
EC	250		17-	•
EC	250	fse	02-	•
MC	250		00-	•
XC	250		17-	•
EC	300		00-16	•
EC	300		17-	•
	400	Pampera	06-	•
EC	400	fse	02	•
EC	450	fse	03-	•
EC	450	FSR	07-16	•
EC	515	fsr	08-16	•

**HM**

	125	Supermotard	00-02	•
CR	125	Supermotard	04-06	•
CRE	125	Enduro	95-06	•
CRE	125	Supermotard	03	•
	250	Supermotard	00-02	•
CRE	250	Enduro	95-03	•
CRE	250	FEnduro	04-13	•
CRE	250	Supermotard	03	•
CRE	250	Supermotard	04-07	•
CRE	250	XEnduro	04-13	•
CRF	250	Supermotard	04-06	•
CRE	450	FEnduro	02-13	•
CRE	450	XEnduro	04-13	•
CRF	450	Supermotard	02-06	•

**HONDA**

CR	125	R	95-07	•
CRE	125		02-07	•
CRF	125	F	14-	•
XLR	125	R	98-	•
XR	125	L	03-	•
CRF	150	F	03-	•
CTX	200		04-	•
CRF	230		04-09	•



CRF	230	L	08-	•
CRF	230	M	09-	•
SL	230		97- 01	•
CR	250	R	95- 07	•
CRE	250		02- 07	•
CRE	250	F	04-	•
CRF	250	R	04- 09	•
CRF	250	R Efi	10-	•
CRF	250	X	04-	•
XLR	250	RSPL	94-	•
XR	250	L	93- 97	•
XR	250	S, R	96-	•
XR	300		10-	•
XR	400	R	96-	•
XR	400	Supemotard	00-	•
XR	440	R	00-	•
CRE	450	F	02-	•
CRF	450	Efi	09- 12	•
CRF	450	R	02- 08	•
CRF	450	R Efi	13- 16	•
CRF	450	R Efi	17-	•
CRF	450	RX Efi	17-	•
CRF	450	X	05-	•
TRX	450	R	04-	•
CR	500	R	95- 01	•
XL	600	V, Transalpino	97- 99	•
XR	600	R	93- 00	•
XL	650	V Transalp	00- 07	•
XR	650	L	93- 12	•
XR	650	R	00- 11	•
TRX	700	XX	08-	•
XL	700	Transalp	08- 11	•
XRV	750	Africa Twin	93- 03	•
<b>KAWASAKI</b>				
KX	125		94- 08	•
KDX	200		94- 99	•
KDX	220	R	97-	•
KLX	250		93- 96	•
KLX	250		98- 07	•
KX	250		94- 08	•
KX-F	250		04- 10	•
KX-F	250	DFI	11- 14	•
KLX	300	R	97-	•
KLX	400	R	03-	•
KLX	400	SR	03-	•
KLX	450	R	07-	•
KX-F	450		06- 08	•
KX-F	450	DFI	09-	•
KX	500		94-	•
KLX	650		93- 96	•
KLX	650	R	93- 95	•
KLX	650	RDI	96	•
<b>SUZUKI</b>				
DR	125	SM	08-	•
RM	125		96- 09	•
DR-Z	250		01-	•
RM	250		96- 09	•
RMX	250		96- 98	•
RMX	250	X-K1	99-	•



RM-Z	250		04- 06	•
RM-Z	250		07- 09	•
RM-Z	250	Efi	10-	•
DR	350	V,W,X	97-	•
DR-Z	400	S/E	00-	•
DR-Z	400	SM	05- 10	•
RMX	450	Z Efi	10	•
RMX	450	Z Efi	17-	•
RM-Z	450		05- 07	•
RM-Z	450	Efi	08-	•
DR	650	SET-W	96-	•

**YAMAHA**

WR	125		98- 02	•
YZ	125		98- 07	•
WR	250		98- 02	•
WR	250	F	01- 13	•
WR	250	F Efi	15-	•
WR	250	R	08-	•
YZ	250		98- 07	•
YZ	250	F	01- 06	•
WR	400	F	98- 00	•
YZ	400		98	•
YZ	400	F	99	•
WR	426	F	01- 02	•
YZ	426	F	00- 02	•
WR	450	F	03- 15	•
YZ	450	F	03- 07	•

**ZERO**

DS		ZF11.4	13- 14	•
DS		ZF8.5	13- 14	•
FX		ZF2.8	13- 14	•
FX		ZF5.7	13- 14	•
MX		ZF2.8	13	•
MX		ZF5.7	13	•
S		ZF11.4	13- 14	•
S		ZF8.5	13- 14	•
SR		ZF11.4	14	•
XU		ZF2.8	13	•
XU		ZF5.7	13	•



# 3051 ORGANIC

## Brake Pads

A 46,9 | L 78,9 | S 7,5

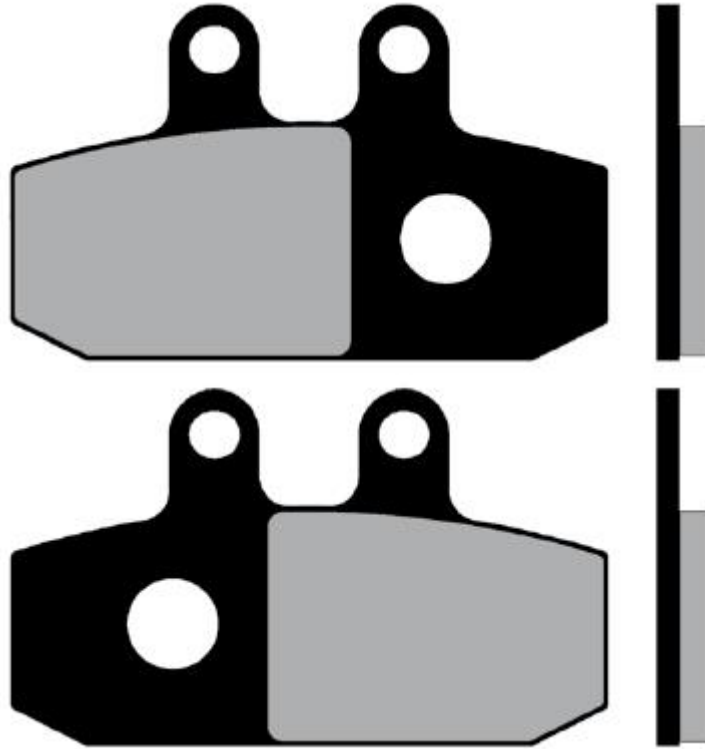

APRILIA

500

Atlantic Right

02-05

•

# Brake Pads

3052 ORGANIC  
4052 SINTERED

A 53,0 | L 53,0 | S 9,0

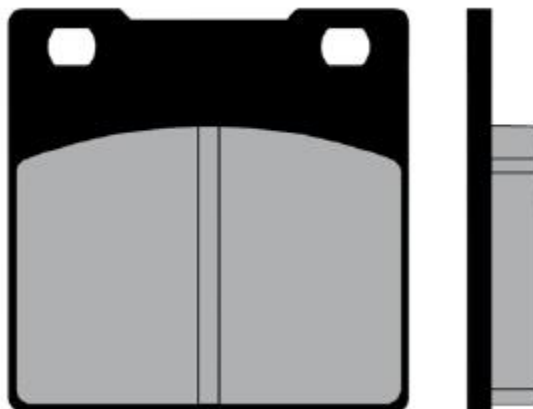

## HONDA







CB	250	N	78-	•
CB	250	NA,NB,I,TZ	77-	•
CB	250	RS	80- 84	•
CM	250	TB	81-	•
CB	400	A	77- 81	•
CB	400	N,T,Hawk	78-	•
CB	400	T1, T2	77- 78	•
CM	400	A, T, TZ	79-	•
CM	400	T	79- 81	•
CB	650		79- 81	•
CB	650	C	80-	•
CB	650	Z	78- 81	•
CB	750	C	80- 81	•
CB	750	KL	79-	•
CB	750	PZ	81-	•

## HYOSUNG

GT	250	Comet	02	•
	600	Comet	02	•

## KAWASAKI

Z	250		78- 80	•
Z	250	J	81-	•
ZX-4	400		90	•
ZXR	400		89- 90	•
ZXR	400		91- 02	•
	600	R, Ninja	89-	•
ZX-7R	750	Ninja	89- 03	•
ZXR	750	R	89- 95	•
ZRX	1100		96- 00	•

					
ZX	1100		93- 97		•
ZZR	1100		94- 01		•
ZRX	1200		01-		•
ZRX	1200	R	01-		•
ZRX	1200	S	01-		•
ZX-12R	1200	Ninja	00- 03		•
ZX-12R	1200	Ninja (Rad.cal)	04- 06		•
ZZR	1200		02-		•
<b>SUZUKI</b>					
RG	125	Wolf	92- 94		•
	250	Across	90-		•
	250	Bandit	90- 96		•
	250	Cobra	90-		•
	250	Wolf	90-		•
GF	250		88-		•
GSX	250	S, Katana	91-		•
GSX-R	250		88- 89		•
GSX-R	250	R	89-		•
RG	250		83- 84	•	•
RG	250	Gamma	84- 88		•
RGV	250		88		•
RGV	250		89- 90		•
TV	250		88		•
	350	Goose	92-		•
GSF	400	Bandit	91-97		•
GSX	400	F	89-		•
GSX	400	FWS	83	•	•
GSX	400	Impulse	94-96		•
GSX	400	S, Katana	92-		•
GSX	400	X	86-		•
GSX-R	400		87		•
GSX-R	400	F	85-86		•
GSX-R	400	R	90-95		•
RF	400	RVC	93- 97		•
GS	500		89- 03		•
GS	500		04-		•
GS	500	F	04-		•
GSX	500		83-	•	•
RG	500		85- 87		•
RG	500	Gamma	85-		•
GS	550		83-	•	•
GSX	550		83- 87	•	•
GSF	600	Bandit	95- 99		•
GSF	600	Bandit /S Bandit Left/Rear	00- 04		•
GSX	600	FW Left	98-		•
GSX	600	Katana	88- 89		•
GSX	600	Katana	90- 97		•
GSX-R	600		92- 03		•
RF	600	R	93- 96		•
SV	650	S Left/Rear	99- 02		•
GS	750	Katana	85-	•	•
GS	750	RF	85-		•
GSX	750	ES	84- 85	•	•
GSX	750	FWS Left/Rear	98- 02		•
GSX	750	Katana	89- 96		•
GSX	750	Left/Rear	98- 08		•
GSX-R	750		85- 87		•
GSX-R	750		88		•
GSX-R	750		88- 99		•



GSX-R	750	Y	00-03			•
IL	1000	RW	98-02			•
IL	1000	SV-Twin	97-01			•
GSX	1100		86-		•	•
GSX	1100	F	93-96			•
GSX	1100	G Left/Rear	96-			•
GSX	1100	Katana	93-			•
GSX-R	1100		86-88			•
GSX-R	1100		89-97			•
GSF	1200	Bandit	95-05			•
GSF	1200	S Bandit	01-05			•
GSX	1200		99-01			•
GSX-R	1300	Hayabusa	99-07			•

# Brake Pads





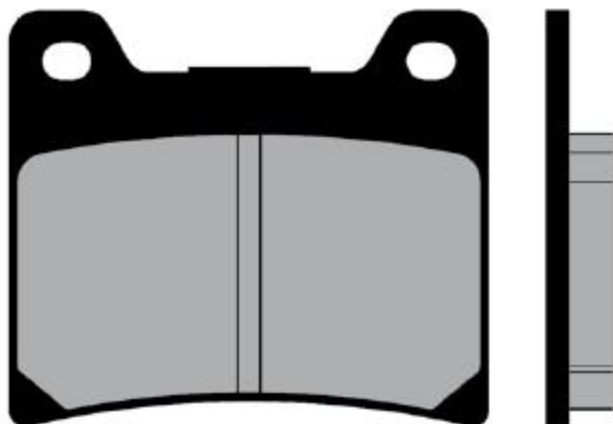

3053 ORGANIC  
4053 SINTERED

A 55,0 | L 63,3 | S 8,7



## YAMAHA

FJ	100	L,LC	84-	•	•
TZR	125		89- 92	•	
TZR	125		93- 94		•
FZ	250	Phazer N,S	85- 86	•	
RD	250	LC	83-		•
YD	250	S	90	•	
RD	350	LC YPVS	83- 84		•
RZ	350		84- 85		•
FZ	400	N	87-	•	
FZR	400		87-	•	
XJR	400	R	95-		•
XS	400	Z	83-	•	•
FZR	500	(Austria)	89	•	•
FZR	500	R (Austria)	90- 91		•
RD	500		83-	•	•
RD	500	LC	84- 86	•	
RZ	500		84- 86	•	
FJ	600		84-	•	•
FZ	600		86- 87	•	•
FZ	600	S,SC	86-	•	
FZR	600		89	•	•
FZR	600	R	90- 95		•
XJ	600		83- 91	•	•
YX	600	Radian	87- 90	•	
YZF	600	R Thunder Cat	96- 03		•
FZ	700		87-	•	•
FZX	700	Fazer	87-	•	•
XJ	700		86-	•	
XJ	700	Maxim	85-	•	•
XV	700	LIC	84-	•	

					
XV	700	Virago	87-	•	
	750	Maxim	81		•
FZ	750		85- 86	•	•
FZ	750	Genesis	86	•	
FZ	750	Genesis	87- 88	•	•
FZ	750	Genesis	89- 92		•
FZR	750	R	89- 92		•
FZR	750	R Genesis	87- 88		•
FZX	750	Fazer	86- 90	•	•
TX	750	A	73- 76		•
VF	750	Virago	88-	•	
XJ	750		83-	•	•
XV	750		89- 92	•	
YZF	750	R, SP	93- 97		•
TDM	850		91- 01		•
TRX	850	(Italy)	95-		•
TRX	850		95- 00		•
XJ	900		83-	•	•
XJ	900	F	85- 93	•	•
XJ	900	S, Diversion	94- 03		•
XV	920	Virago	81-		•
FZR	1000		94- 95		•
FZR	1000	EXUP	90- 93		•
FZR	1000	Genesis	87- 89		•
GTS	1000		93- 99		•
XV	1000	L, C	84-	•	•
XV	1000	Virago	86-	•	
YZF	1000	R Thunder Ace	96- 99		•
BT	1100	Bulldog	02- 06		•
FJ	1100		83- 85	•	•
XV	1100	Virago	86- 93	•	
XV	1100	Virago	99		•
XVS	1100	Drag Star	99- 06		•
XVS	1100	Drag Star Classic	00- 06		•
FJ	1200		86- 87	•	•
FJ	1200		88- 90		•
FJ	1200	ABS	91- 93		•
V-MAX	1200		85- 89	•	•
V-MAX	1200		90- 92	•	•
V-MAX	1200		93- 03		•
XJR	1200	(Italy)	95- 98		•
XJR	1200		94- 98		•
XJR	1200	SP	97- 98		•
XV	1200		84-	•	•
XV	1200	Venture Royale	85	•	•
XV	1200	Z12T	84-	•	•
XVT	1200	T, Vent. Royale	84-	•	•
XJR	1300		99- 01		•
XJR	1300	SP	01		•

# Brake Pads

3054 ORGANIC

4054 SINTERED

A 53,0 | L 53,0 | S 8,0

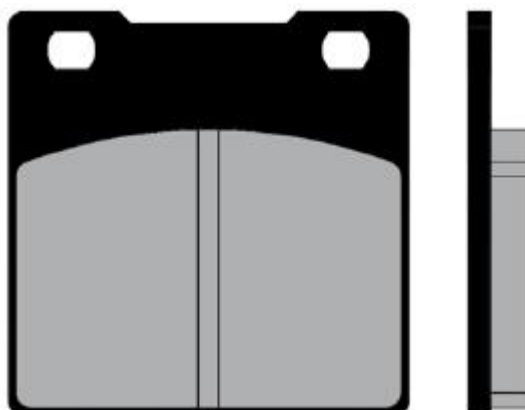

## KAWASAKI

Z	250	A1-A2	79-80	•
Z	250	A3	81-	•
Z	250	J1	81-	•
ZZR	1100	GI (ZX1100D)	93-	•

# Brake Pads

3055 ORGANIC  
4055 SINTERED

A 42,0 | L 77,0 | S 7,5

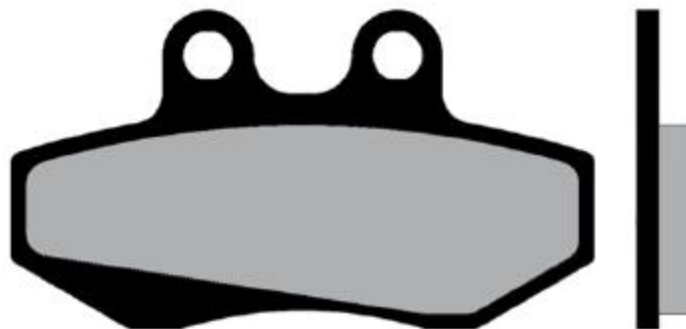

## APRILIA

RX	50		06-	•
SX	50		06- 13	•
	125	Classic	96-	•
	125	Pegaso	90- 91	•
	125	Red Rose	90-	•
	125	Tuareg Rally	92	•
	125	Tuareg Wind	90-	•

## BETA

RR	50	Enduro	99-	•
RR	50	Pro Race	98-	•
RR	50	Standard	99-	•
RR	50	Supernotard	99- 03	•

## BULTACO

	50	Astro	01-	•
	50	Lobito	99-	•

## DERBI

	50	Senda RDRD	03- 04	•
GPR	50	R	98-	•
	125	Atmosphere	99-	•
	180	Predator	99-	•

## GAS GAS

EC	50	Rookie	01- 04	•
SM	50	Rookie	01-	•

## GILERA

FX	125	Runner	97- 99	•
FX	150	Runner	97-	•
FXR	180	Runner	97	•
FX	200	Runner	97- 98	•

## HRD

	50	GS Enduro	00- 02	•
--	----	-----------	--------	---





	50	Sonic 2 Supermotard	00- 02	•
	50	Sonic 2 Trail	00- 02	•
	125	Supermotard	00- 02	•
	125	Trail	00- 02	•
<b>HUSQVARNA</b>				
SM	50		02-	•
WR	50		02-	•
<b>ITALJET</b>				
SM	50		02-	•
SM	125		02-	•
<b>MOTORHISPANIA</b>				
RX	50	Racing	00-	•
RYZ	50	Supermotard	05-	•
<b>PEUGEOT</b>				
XR6	50	Race Spec	02- 07	•
<b>RIEJU</b>				
	50	Racing, Spec. Edition	01-	•
	50	Spike Racing	02-	•
MRX	50	Pro	05-	•
SMX	50		02-	•
MRX	125		03-	•
SMX	125		03-	•
<b>SHERCO</b>				
	50	Supermotard, Enduro	02- 06	•
<b>SIAMOTO</b>				
	125	BD, KD	02-	•
<b>SIMSON</b>				
	125	SM	01-	•
<b>TOMOS</b>				
SE	50		05-	•

# Brake Pads

3056 ORGANIC  
 4056 SINTERED  
 6056 OFF ROAD

A 42,0 | L 64,0 | S 9,0

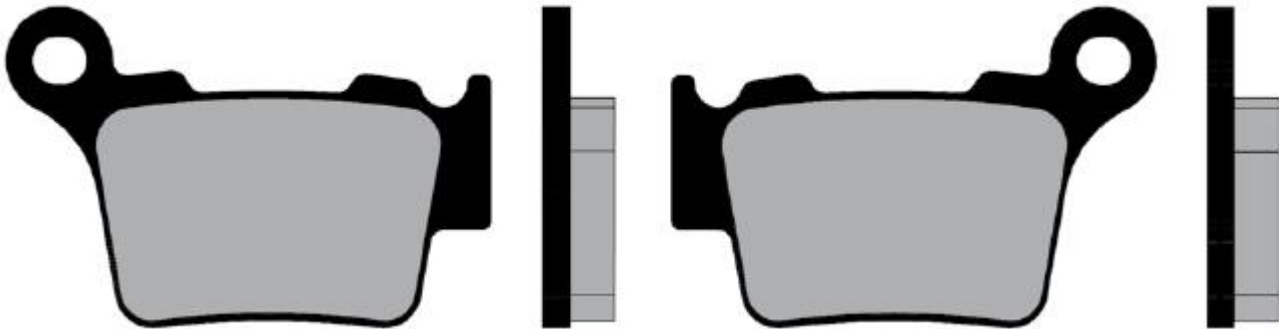

## BMW

G	450	SMR	09- 10	•
G	450	X	08- 10	•

## BREMBO RACING CALIPERS







Off Road XQ21390, PF 26

## HUSABERG

TE	125		13	•
FE	250		13	•
TE	250		11- 13	•
TE	300		11- 13	•
FE	350		13	•
FE	390		10- 13	•
FE	450		09- 13	•
FE	501		13	•
FE	570		09- 13	•

## HUSQVARNA

CR	125		05- 13	•
TC	125		14-	•
TE	125		14-	•
CR	250		05	•
FC	250		14-	•
FE	250		14-	•
TC	250		04- 13	•
TC	250		14-	•
TE	250		14-	•
TE	250	4T	10- 13	•
TC	300		14-	•
TE	300		14-	•
WR	300		09- 13	•
TE	310	4T	10- 13	•
FC	350		14-	•

											
FE	350					14-					•
SMR	449					11-					•
TC	449					11- 13					•
TE	449					11- 13					•
FC	450					14-					•
FE	450					14-					•
FS	450					15-					•
SM	450	R				06-					•
SM	450	RR				06-					•
TC	450					04- 10					•
TE	450					14-					•
FE	501					14-					•
SM	510	Centennial				06-					•
SM	510	R				06-					•
TC	510					04- 10					•
SMR	511					11-					•
TE	511					11- 13					•
TE	511					14-					•
SM	610	ie				07-					•
SM	630					10-					•
TE	630					10- 13					•
TE	630					14-					•
SIR	650	CRC				07-					•
<b>KTM</b>											
EXC	125	Enduro				04-					•
SX	125					04-					•
SX	144					07- 08					•
SX	150					09-					•
EXC	200	Enduro				04-					•
SX	200					03- 04					•
EXC	250	Enduro				04-					•
EXC	250	Enduro4T				04- 06					•
EXC-F	250	Enduro				07-					•
SX	250					03-					•
SX-F	250					06-					•
EXC	300	Enduro				04-					•
EXC-F	350					11-					•
SX-F	350					11-					•
EXC	400	Racing				04-					•
EXC	450	Racing				04-					•
SX	450	SM Factory Replica				04-					•
SX	450	SMR				04-					•
SX-F	450					03-08					•
XCF	450					06-					•
SX	505	Racing				07-					•
XCF	505					08- 09					•
EXC	525	Racing				04-					•
SX	525	SMR				04-					•
SX-F	525	Racing				04- 06					•
EXC	530	Racing				08-					•
SX	560	SMR				06-					•
<b>RIEJU</b>											
MRX	250	Marathon				10-					•
MRX	450	Marathon				08-					•
<b>SHERCO</b>											
SE-R	125					17-					•
SE	250	R				14-					•
SE	250	F, F-R				14-					•
SE	250	i/iR				12- 13					•



SE	250	i-F	13	•
SCF-R	300		16-	•
SE	300	R	14-	•
SE	300	F, F-R	14-	•
SE	300	i/iR	12- 13	•
SE	300	i-F	13	•
SE	450	F, F-R	14-	•
SE	450	iR	12- 13	•
SE	510	iR	12- 13	•
<b>SWM</b>				
RS	300	R	15-	•
SM	450	R	15-	•
RS	500	R	15-	•
<b>WRM</b>				
	450	MX	06-	•

# Brake Pads

3057 ORGANIC  
4057 SINTERED

A 41,0 | L 102,0 | S 10,0



## YAMAHA

FZX	250	Zeal	91- 92	•
SRV	250		92- 97	•
XJ	400	Diversion	91-	•
YP	400	Majesty	04	•
XP	500	TMAX	01- 03	•
XV	535	DX Virago	98- 03	•
XV	535	S Virago	96- 03	•
XJ	600	N	91- 97	•
XJ	600	S Diversion	91- 97	•
XVS	650	A Drag Star Classic	98- 06	•
XVS	650	Drag Star	97- 06	•
XV	750	Virago	94- 97	•
XJ	900	S, Diversion	94- 03	•
SCR	950	Scrambler	17-	•
XV	950	Bolt	14-	•
XV	950	Bolt C-Spec	15-	•
XV	950	Bolt R-Spec	14-	•
XVS	950	A Midnight Star	09-	•
XV	1100	Virago	94- 98	•
XVS	1300	Stryker	11-	•
XVZ	1300	TF Royal Star Venture	99-	•
XV	1600	A Wild Star	99- 07	•

# Brake Pads

3058 ORGANIC  
4058 SINTERED

A 38,6 | L 100,0 | S 11,7

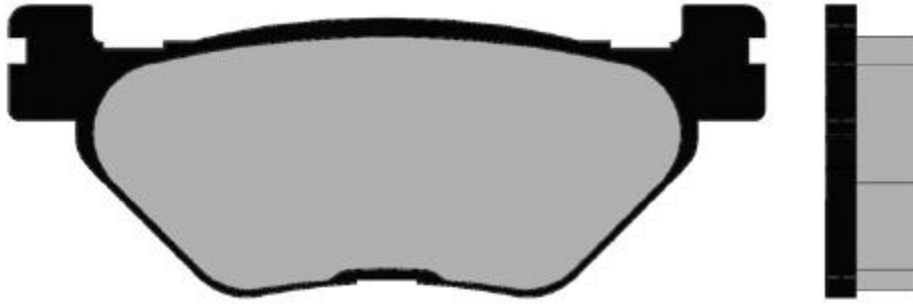

**YAMAHA**

XP	500	TMAX	01- 03	•
XP	530	TMAX	12-	•
XP	530	TMAX DX	17-	•
XP	530	TMAX Iron Max	15-	•
XP	530	TMAX SX	17-	•

# Brake Pads

3059 ORGANIC  
4059 SINTERED

A 39,0 | L 102,0 | S 8,3

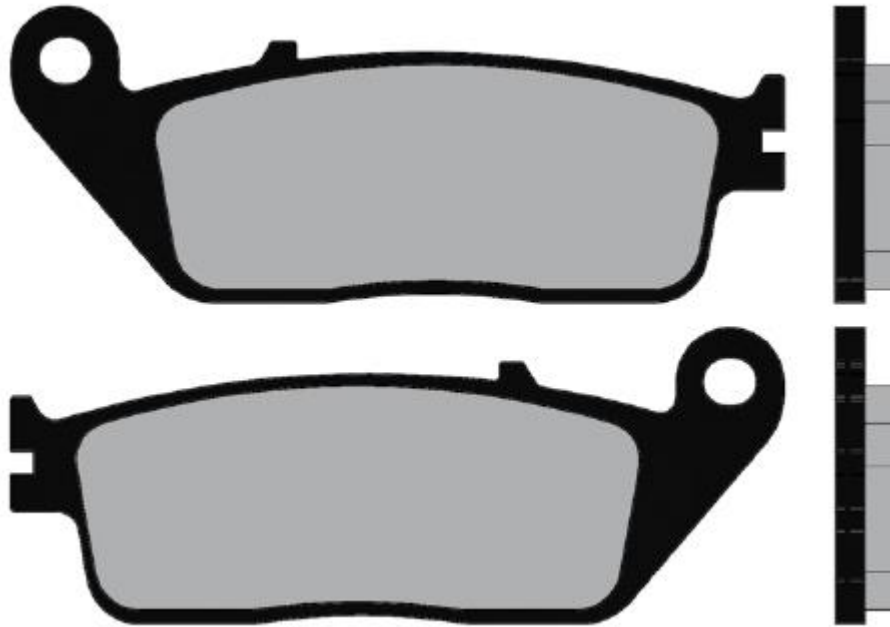

## BMW

C		Evolution	12-	•	•
C	600	Sport	12- 15	•	•
C	650	GT	12- 15	•	•
C	650	GT	16-	•	•
C	650	Sport	16-	•	•

## BUELL

	500	Blast	01- 09	•	
--	-----	-------	--------	---	--

## CAGIVA







	900	Gran Canyon	99- 04	•	
	1000	Navigator, T	00- 05	•	

## DAELIM







	125	S2	06-	•	
	250	S2	06-	•	

## HONDA

NSS	125	Forza	15-	•	
SH	125		13-	•	
SH	150		13-	•	
CN	250	Helix (Fusion)	93-	•	
SH	300	iSH30	15-	•	
RS	125	R	91- 94	•	
	250	Steed	93-	•	
CB	250		92- 05	•	
CBR	250	Nighthawk	92-	•	
CBR	250	R (Nissin cal)	11- 13	•	
CBR	250	R, RR	90	•	
CBR	250	RJ	88	•	

					
VT	250	Spada	89	•	
CB-1	400	(CB 400 F)	89- 90	•	
CBR	400	RR	87- 89	•	
FJS	400	Silverwing	06- 08		•
SW-T	400		09- 13		•
SW-T	400	ABS	09-		•
NV	400	Steed	92- 93	•	
CB	500		94- 96	•	
	600	Steed	92-	•	
CB	600	Hornet	98- 12	•	
CB	600	HornetS	00- 03	•	
CBF	600	N	04- 11	•	
CBF	600	S	04- 11	•	
CBR	600	F	11-	•	
CBR	600	F3	95- 98	•	
FJS	600	Silverwing	01-		•
SW-T	600		11- 13		•
VT	600	C,Shadow	94- 00	•	
VT	600	CDShadowVLX	94- 00	•	
FMX	650		05- 08	•	
NT	650	Hawk GT	88- 91	•	
NIV	650	Revere	88- 93	•	
NC	700	S	12- 13	•	
NC	700	X	12- 13	•	
VFR	700	F Interceptor	88- 89	•	
CB	750	N, F, Seven Fifty	92- 95	•	
VFR	750	F	88- 98	•	
PC	800	Pacific Coast	89- 97	•	
VFR	950	F, Carat	92-	•	
CBR	1000	F	89- 92	•	
VFR	1000		89	•	
ST	1100		90- 02	•	
ST	1100	ABS-TCS	92- 95	•	
VT	1100	CShadow	94- 96	•	
VT	1100	C2Shadow A.C.E.	95-	•	
VT	1100	C2Y	00-	•	
VT	1100	C3Shadow Aero	98-	•	
VT	1100	TShadow	98-	•	
VT	1300	CXA Fury	10- 12	•	
VIX	1300	C	04- 09	•	
VIX	1300	S	03- 07	•	
GL	1500	F6 C Valkyrie	96- 02	•	
<b>HYOSUNG</b>					
	125	V2	99-	•	
	250	Aquila	00-	•	
<b>KAWASAKI</b>					
J	125		16-	•	
	250	Versys-X	17-	•	
J	300		14-	•	
KLE	650	Versys	15-	•	
KLE	650	VersysLT	15-	•	
Z	650		17-	•	
Z	750	ABS	07- 12	•	
Z	800	e	13-	•	
<b>KYMCO</b>					
	125	Downtowni	10-	•	
	125	G-Dink	12-	•	
	125	Super Dink	10-	•	
	200	Downtowni	10-	•	



					
250	Venox	01-	•	•	
250	Xciting	04- 05	•	•	
250	Xciting	06-	•		
300	Downtowni	10-	•		
300	G-Dink	12-	•		
300	People Gti	10-	•		
300	Xciting Ri	08-	•		
500	Xciting	04-	•		
500	Xciting i Evo ABS	11-	•		
500	Xciting R ABS	09-	•		
700	MyRoad, ABS	09-	•		
<b>MASH</b>					
400	Scrambler	13-	•		
500	Five Hundred	13-	•		
<b>PEUGEOT</b>					
125	Satelis ABS	04-	•		
300	Geopolis GT	14-	•		
400	Geopolis GT	14-	•		
400	Geopolis RS	08-	•		
400	Satelis i	14-	•		
500	Satelis	07-	•		
600	Satelis ABS	04-	•		
<b>SUZUKI</b>					
250	Impulse	95	•		
DL	250	V-Strom	17-	•	
GSX-R	250		17-	•	
GW	250	Inazuma	12-	•	
GW	250	Inazuma F	15-	•	
GSX	400	Impulse	94- 96	•	
RF	400	RVC	93- 97	•	
GSF	600	Bandit	95- 99	•	
RF	600	R	93- 96	•	
AN	650	A Burgman Executive	04- 12	•	
AN	650	Burgman	02-	•	
AN	650	Z Burgman Executive	13-	•	
C	1500	T Intruder	13-	•	
<b>SWM</b>					
440	Gran Milano	15-	•		
440	Gran Turismo	15-	•		
440	Silver Vase	15-	•		
<b>TRIUMPH</b>					
675	Street Triple	08-	•		
800	America	03- 06	•		
800	Bonneville	01- 04	•		
800	Bonneville America	02-	•		
800	Bonneville T100 Centennial Edition	02- 04	•		
800	Bonneville T100 Paul Smith	06- 08	•		
800	Speedmaster	03- 04	•		
800	Tiger	11- 14	•		
800	Tiger XC	11-	•		
800	Tiger XC ABS	12- 14	•		
800	Tiger XCA	15-	•		
800	Tiger XCR	15-	•		
800	Tiger XR	15-	•		
800	Tiger XRT	15-	•		
800	Tiger XRX	15-	•		
900	Adventurer	96-	•		
900	America	07-	•		
900	Bonneville	05-	•		



# Brake Pads

3060 ORGANIC  
4060 SINTERED

A 53,0 | L 89,6 | S 8,0

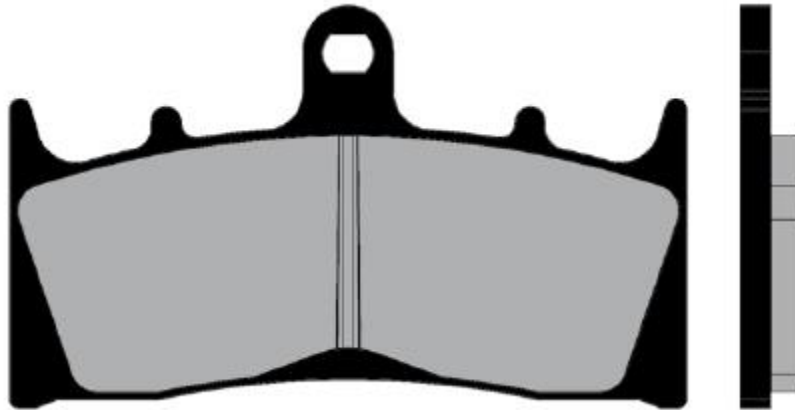

## JAYBRAKE

4 Piston Caliper A4 P/L

4 Piston J-Four Caliper

## KAWASAKI

ZX-6R	600	Ninja	98- 01	•
ZX-6R	636	Ninja	02	•
ZX-7R	750	Ninja	96- 03	•
ZX-9R	900	Ninja	96- 01	•
ZRX	1100		96- 00	•
ZRX	1200		01-	•
ZRX	1200	R	01-	•
ZRX	1200	S	01-	•
ZX-12R	1200	Ninja	00- 03	•
VN	1500	Mean Streak	02- 03	•
VN	1600	Mean Streak	04	•

## SUZUKI

GSX-R	750		94- 99	•
GSX-R	1000		01- 02	•
TL	1000	RW	98- 02	•
GSX-R	1100		93- 97	•
GSF	1200	Bandit	01- 05	•
GSF	1200	S Bandit	01- 05	•
GSX-R	1300	Hayabusa	99- 07	•
GSX	1400		02- 07	•
VZ	1600	Marauder	04	•

# Brake Pads

3061 ORGANIC  
4061 SINTERED

A 51,2 | L 110,8 | S 10,0  
A 43,6 | L 69,1 | S 10,0

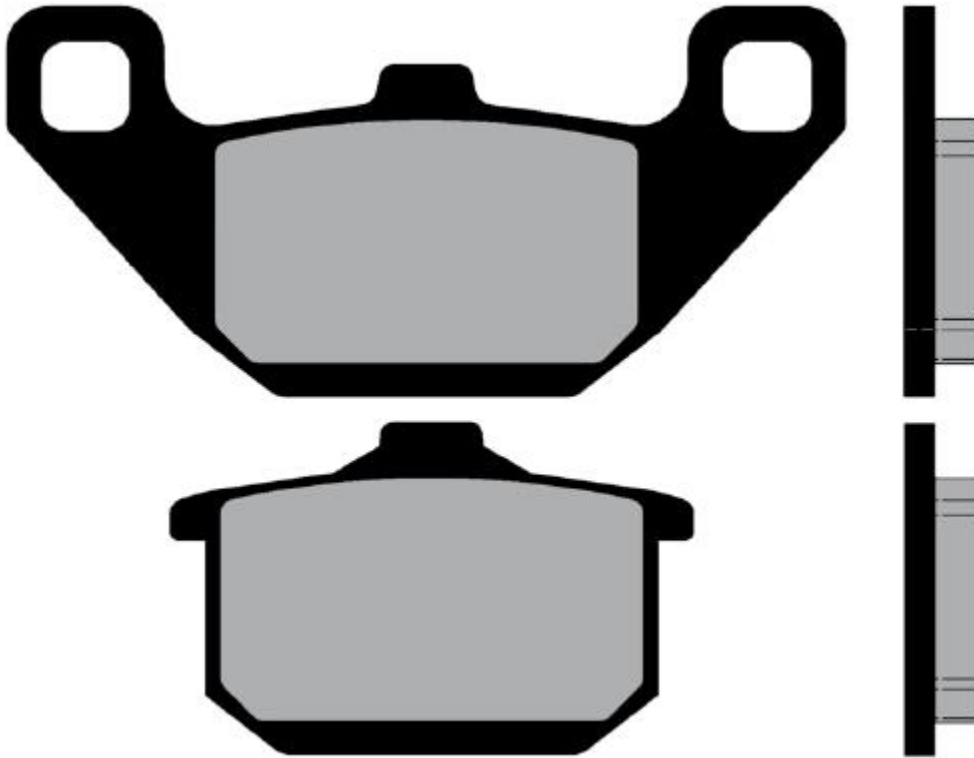







## HYOSUNG

		GA4	99-	•
GA	300		98-	•

## KAWASAKI

BR	250		86-	•
CS	250		86-	•
EL	250		91- 94	•
EL	250		93- 94	•
EL	250	Eliminator	88- 89	•
EX	250	R Ninja	86- 87	• •
GPZ	250		83-	•
GPZ	250	R	86-	• •
KR	250		85	•
LX	250	Eliminator, SE	90-	•
Z	250	Eliminator	88	•
EL	252		97- 00	•
EX	305		83	•
GPZ	305		83- 96	•
	400	Eliminator	94-	•
EN	400	Twin	85-	•
FX	400	R	86- 88	•
GPZ	400		85- 87	•
KLE	400	Vulcan	90-	•

					
Z	400	Eliminator	88	•	•
ZX	400		85		•
ZX	400		86-	•	•
EN	450		85- 90	•	
Z	450	LTD	84-	•	
EN	500		90- 96	•	
EN	500		98-	•	
EN	500	Vulcan	96- 97	•	
GPZ	500	R (Austria)	85-	•	•
GPZ	500	S	87	•	
GPZ	500	S	89- 92		•
ZL	500	(Austria)	85-	•	
GPZ	550		84- 87	•	•
GT	550		85- 01	•	
Z	550	F	85-	•	
ZX	550		84-	•	•
GPZ	600	R	85- 89	•	•
Z	600	GP	83-	•	•
ZL	600		85-	•	
ZX	600	Ninja	85- 87	•	•
VN	700	Vulcan	85	•	
ZN	700		84-	•	•
	750	Vulcan	93-	•	
GPZ	750		83- 87	•	•
GPZ	750	R	85- 86	•	•
GPZ	750	T	83-	•	•
GT	750		86-	•	•
VN	750	Vulcan	86- 94	•	
VZ	750	Twin	88	•	
Z	750		83- 84	•	
Z	750	Eliminator	88	•	•
Z	750	LTD Twin	83-	•	•
Z	750	Turbo	84-	•	•
ZX	750	E, GP	83- 85	•	•
VN	800	Vulcan, Classic	95-	•	
GPZ	900	R	84- 89	•	•
ZL	900	Eliminator	85- 86	•	•
ZX	900		83- 84	•	•
GPZ	1000	RX	86-	•	•
GTR	1000		86- 93	•	•
GTR	1000		94- 06		•
Z	1000	R Ninja	86-	•	•
ZL	1000		86-	•	•
GPZ	1100		83-	•	•
Z	1100	GP	83-	•	•
Z	1100	LTD	85-	•	•
Z	1100	R, LTD	84	•	•
ZN	1100	LTD	84-	•	•
ZX	1100	GP	83-	•	•
ZG	1200	Voyager XII	86-	•	•
Z	1300		85	•	•
ZN	1300		83- 84	•	•
ZN	1300	Voy.	85-	•	•
VN	1500	Classic	97-		•
VN	1500	Classic Tourer Left/Rear	98-		•
VN	1500	Sumo	88-	•	•
VN	1500	Vulcan	87-	•	•
VN	1500	Vulcan, SE	87- 92	•	•

# Brake Pads

3062 ORGANIC  
4062 SINTERED

A 46,0 | L 69,6 | S 8,4

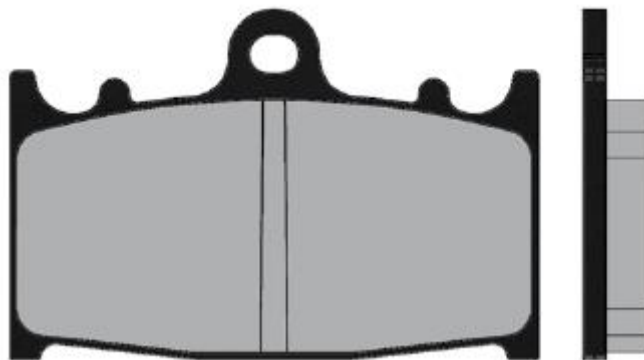

## BERINGER

4 Piston Caliper

## HUSABERG

FS	400	e, c	01- 03	•
FS	450	e, c	03- 05	•
FS	650	e, c	01- 05	•

## KAWASAKI

KR-1	250	S	90	•
ZX-4	400		90	•
ZXR	400		89- 90	•
ZZR	400		90- 94	•
GPZ	500		93- 95	•
ZZR	500	(Austria)	90-	•
	600	R, Ninja	89-	•
ZX-6R	600	(Ninja ZX6)	93- 97	•
ZX-6R	600	(Ninja ZX6R)	95- 97	•
ZX-6R	600	(ZX6)	90- 93	•
ZZR	600		90- 05	•
ZX-7R	750	Ninja	89- 95	•
ZXR	750	R	89- 95	•
GPZ	900	R	90- 96	•
ZX-9R	900	Ninja	94- 95	•
	1000	Versys	12-	•
	1000	Versys ABS	15- 16	•
	1000	Versys LT	15-	•
ZR	1100	Zephyr	92- 95	•
ZX	1100		93- 97	•
ZZR	1100		90- 01	•
ZZR	1200		02-	•
VN	1700	Voyager	09-	•
VN	2000		04-	•



**MOTO-MASTER**

Supernoto Racing Caliper

**SUZUKI**

RG	125	F,Gamma	92- 96	•
RG	200	Gamma	91-	•
	250	Cobra	90-	•
	250	Wolf	90-	•
GSX-R	250	R	89-	•
RGV	250		89- 95	•
RGV	250	Gamma	91- 92	•
TV	250		88	•
	350	Goose	92-	•
GSF	400	Bandit	93- 97	•
GSX	400	S, Katana	92-	•
GSX-R	400		88- 89	•
GSR	600		06- 10	•
GSX-R	600		97- 03	•
GSF	650	Bandit	07-	•
GSF	650	Bandit ABS	07- 12	•
GSF	650	S Bandit	07-	•
GSF	650	S Bandit ABS	07- 13	•
GSX	650	F	08- 13	•
GSX-R	750	Y	00- 03	•
SV	1000	S	03- 07	•
IL	1000	SV-Twin	97- 01	•
GSF	1200	Bandit	06	•
GSF	1200	S Bandit	06	•
GSF	1250	A Bandit	07-	•
GSF	1250	Bandit	06-	•
GSF	1250	F Bandit	12-	•
GSF	1250	S Bandit	06-	•
GSF	1250	SA Bandit	07-	•
GSX	1250	FA Bandit	16-	•
GSX	1250	FA Traveller	15-	•
C	1500	Intruder Left/Rear	05- 10	•
VL	1500	Intruder LC Left/Rear	02	•

# Brake Pads

3063 ORGANIC  
4063 SINTERED

A 42,0 | L 96,5 | S 7,4  
A 42,0 | L 77,0 | S 7,8

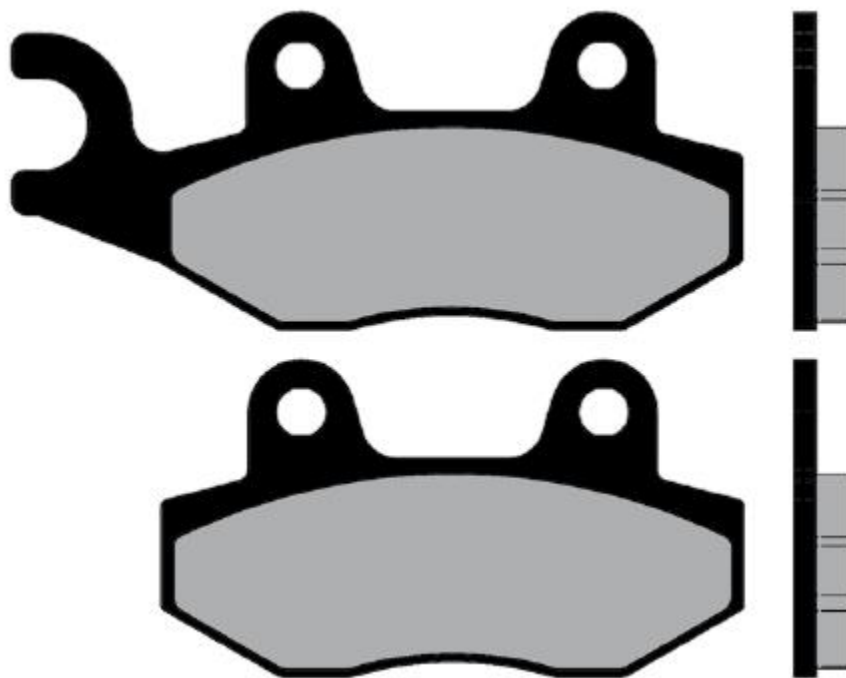

<b>APRILIA</b>				
SX	50	Ltd.	14	•
<b>ATK</b>				
		all models	94	• •
<b>BENELLI</b>				
	125	Caffenero Left/Rear	08-	• •
	125	MJ	10-	• •
	150	MJ	10-	• •
	250	Caffenero Left/Rear	08-	•
<b>CAGIVA</b>				
	110	Passing	94-	•
	600	Canyon	95-	•
<b>CAN-AM</b>				
	800	Commander Left/Rear	11-	•
	800	Commander Right	11-	•
	1000	Commander Left/Rear	11-	•
	1000	Commander MAX Right	14-	•
	1000	Commander Right	11-	•
	1000	Maverick Right	13-	•
<b>CF MOTO</b>				
	550	U-Force Right	15-	•
	550	Z-Force Right	15-	•
	800	Z-Force EX Right	15-	•
<b>DERBI</b>				
DXR	200	Quad (Front drum)	04-	•
DXR	250	Quad (Front drum)	04-	•



**GARELLI**

	200	Xo	12-	•
--	-----	----	-----	---

**HONDA**

NSR	150		02-	•
-----	-----	--	-----	---

**HOREX**

VR6	1200		11- 16	•
-----	------	--	--------	---

**HUSQVARNA**

		all models CR, TC, TE, WR	92- 94	•
--	--	---------------------------	--------	---

**HYOSUNG**

	125	Aquila	00-	•
--	-----	--------	-----	---

**KAWASAKI**

KLX	125		10- 14	•
-----	-----	--	--------	---

KLX	125	D-Tracker	10- 14	•
-----	-----	-----------	--------	---

KX	125		89- 93	•
----	-----	--	--------	---

KLX	140	L	08-	•
-----	-----	---	-----	---

KLX	150	D-Tracker	16-	•
-----	-----	-----------	-----	---

KLX	150	L	14-	•
-----	-----	---	-----	---

KDX	200		93	•
-----	-----	--	----	---

KDX	250	SR	91- 94	•
-----	-----	----	--------	---

KLX	250		14-	•
-----	-----	--	-----	---

KLX	250	S	09-	•
-----	-----	---	-----	---

LX	250	SF	09-	•
----	-----	----	-----	---

KX	250		89- 93	•
----	-----	--	--------	---

EL	252		01-	•
----	-----	--	-----	---

KLF	300	Bayou Left/Rear	89- 05	•
-----	-----	-----------------	--------	---

KLF	400	Bayou Left	93- 99	•
-----	-----	------------	--------	---

KX	500		89- 93	•
----	-----	--	--------	---

KLR	650		08-	•
-----	-----	--	-----	---

KVF	650	Brute Force 4x4i Left	05-	•
-----	-----	-----------------------	-----	---

KRF	750	Teryx 4x4 Left	08-	•
-----	-----	----------------	-----	---

KVF	750	Brute Force 4x4i Left	05-	•
-----	-----	-----------------------	-----	---

	800	Mule Pro FX Left	15-	•
--	-----	------------------	-----	---

KRF	800	Teryx BEF/ CEF/DEF Left	14-	•
-----	-----	-------------------------	-----	---

KRT	800	Teryx4 BEF/CEF/DEF Left	14-	•
-----	-----	-------------------------	-----	---

**KYMCO**

S	250	People Left/ Rear	06-	•
---	-----	-------------------	-----	---

**PEUGEOT**

	50	Django Heritage	14-	•
--	----	-----------------	-----	---

	125	Django Heritage	14-	•
--	-----	-----------------	-----	---

	125	Geopolis (Nissin cal.)	07-	•
--	-----	------------------------	-----	---

	125	Vivacity	10-	•
--	-----	----------	-----	---

GT	125	Satelis Sport	11-	•
----	-----	---------------	-----	---

	150	Django Heritage	14-	•
--	-----	-----------------	-----	---

	300	Geopolis GT	14-	•
--	-----	-------------	-----	---

	300	Geopolis Premium (Nissin cal.)	10-	•
--	-----	--------------------------------	-----	---

	300	Geopolis RS (Nissin cal.)	10-	•
--	-----	---------------------------	-----	---

	300	Geostyle (Nissin cal.)	10-	•
--	-----	------------------------	-----	---

	300	Satelis	13-	•
--	-----	---------	-----	---

	400	Geopolis (Nissin cal.)	07-	•
--	-----	------------------------	-----	---

	400	Geopolis GT	14-	•
--	-----	-------------	-----	---

	400	Geopolis RS	08-	•
--	-----	-------------	-----	---

	400	Satelis i	14-	•
--	-----	-----------	-----	---

	500	Satelis	07-	•
--	-----	---------	-----	---

**PGO**

	125	Libra	10-	•
--	-----	-------	-----	---

	125	X-Hot	10-	•
--	-----	-------	-----	---

**SUZUKI**

AN	400	Burgman Left/ Rear	07- 16	•
----	-----	--------------------	--------	---

AN	400	Burgman Left/ Rear	17-	•
----	-----	--------------------	-----	---

											
EN	125					05-		•			
RM	125					87		•			
RM	125					88- 95		•			
TS	125					89- 96		•			
TS	200	R				90- 94		•			
DR	250					90- 95		•			
RM	250					88- 95		•			
RMX	250					89- 95		•			
LT-F	300	King Quad	Left/Rear			02-		•			
DR	350					90- 99		•			
LT-R	450	Left/Rear				06-		•			
LT-A	500	FY Quadmaster	Left			00-		•			
LT-F	500	F Right				98-		•			
RM	500					87-		•			
<b>TRIUMPH</b>											
	750	Trident	Left/Rear			91-		•		•	
	800	America				03- 06				•	
	800	Bonneville				01- 04				•	
	800	Bonneville	America			02-				•	
	800	Bonneville	T100 Centennial Edition			02- 04				•	
	800	Bonneville	T100 Paul Smith			06- 08				•	
	800	Speedmaster				03- 04				•	
	900	America				07-				•	
	900	Bonneville				09-				•	
	900	Bonneville	Newchurch			15-				•	
	900	Bonneville	SE			09- 13				•	
	900	Bonneville	Spirit			15-				•	
	900	Bonneville	Street Cup			17-				•	
	900	Bonneville	T100			05- 08				•	
	900	Bonneville	T100			09- 16				•	
	900	Bonneville	T100			17-				•	
	900	Bonneville	T100 Black			17-				•	
	900	Bonneville	T214			15-				•	
	900	Daytona, Sprint	Left/Rear			93		•		•	
	900	Scrambler				06- 16				•	
	900	Speedmaster				05-				•	
	900	Street	Scrambler			17-				•	
	900	Street	Twin			16-				•	
	900	Thruxton				04-				•	
	900	Thruxton	Ace			15				•	
	900	Tiger	Left/Rear			93- 98		•		•	
	900	Trident	Left/Rear			91-		•		•	
	900	Trophy	Left/Rear			91- 95		•		•	
T509	900	Speed	Triple			97- 01				•	
T595	950	Daytona				96- 98				•	
	955	Daytona	Centennial			02-				•	
	955	Daytona	to VIN 132512			99-				•	
	955	Speed	Triple			99-				•	
	955	Sprint	RS			00-				•	
	955	Sprint	ST			99- 04				•	
	1000	Trophy	Left/Rear			91- 95		•		•	
	1050	Speed	94			15-				•	
	1050	Speed	94R			15-				•	
	1050	Speed	Triple			16-				•	
	1050	Speed	Triple (Rad.cal)			05- 15				•	
	1050	Speed	Triple R			12- 15				•	
	1050	Speed	Triple R			16-				•	
	1050	Speed	Triple S			16-				•	
	1050	Sprint	GT ABS			11-				•	



1050	Sprint ST	05- 11	•
1050	Tiger Sport	15-	•
1200	Bonneville Bobber	17-	•
1200	Bonneville T120	16-	•
1200	Bonneville T120 Black	16-	•
1200	Thruxton	16-	•
1200	Thruxton R	16-	•
1200	Tiger Explorer	12-	•
1200	Trophy Left/Rear	91- 95	• •
1200	TrophySE	13-	•

**YAMAHA**

FZR	50		92-	•
YD	80		89-	•
WR	125		91- 97	•
XTZ	125		05-	•
YZ	125		89- 97	•
DT	200	WR	91- 93	•
WR	200		91- 92	•
TTR	230		05-	•
TT	250		93- 03	•
WR	250		90- 97	•
YZ	250		89	•
YZ	250	A	90	•
YZ	250	B1-J1	91- 97	•
YZ	250	WRA,WRB	90- 91	•
TT	350		95-	•
YZ	360		89	•
YFZ	450	S Right	04- 09	•
YXR	450	Rhino Left/Rear	06-	•
WR	500	B	91	•
WR	500	ZD,ZE	92- 93	•
	660	Rhino Left/Rear	05-	•
YFM	700	R Raptor Left/Rear	06- 08	•
YFM	700	Raptor	09-	•
YXR	700	Rhino Right	08-	• •
XTZ	750	Super Tenere Left/Rear	89- 95	•

# Brake Pads

3064 ORGANIC  
4064 SINTERED

A 42,0 | L 96,5 | S 7,5  
A 42,0 | L 77,0 | S 7,7

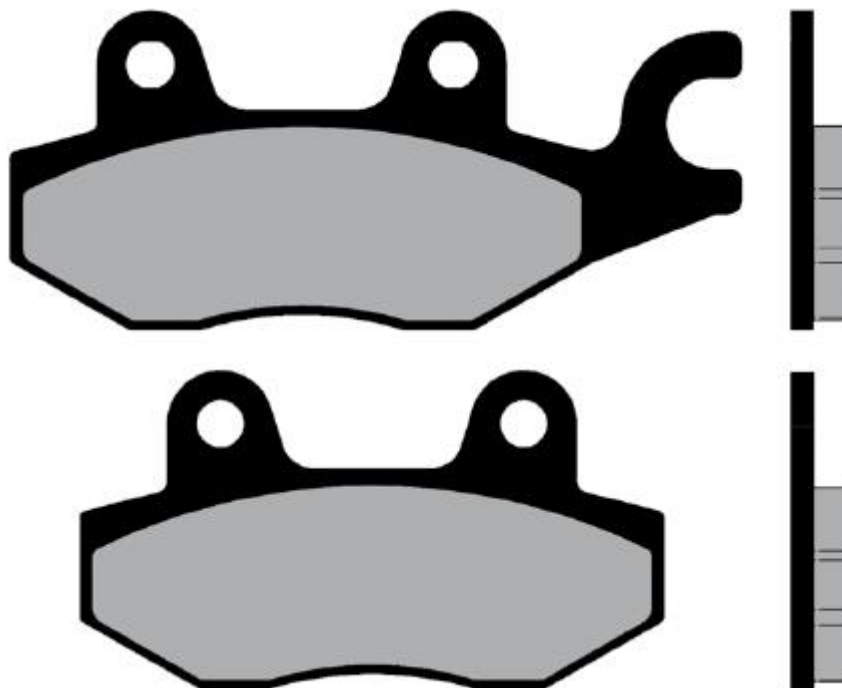

## AEON

125	Overland	02-	•
180	Overland	02-	•
180	Roadster	02-	•

## ARCTIC CAT

50	DVX	06-	•
90	DVX	06-	•

## BENELLI

125	Caffenero Right	08-	•
250	Caffenero Right	08-	•

## CAGIVA







500	Canyon	99-	•
600	Canyon	95-	•
900	Canyon I.E.	97-	•
900	Elefant I.E.	91- 92	•
900	Gran Canyon	99- 04	•
1000	Navigator, T	00- 05	•

## CAN-AM

800	Commander Left/Rear	11-	•
1000	Commander Left/Rear	11-	•
1000	Commander MAX Left	14-	•
1000	Maverick Left	13-	•

## CF MOTO

550	U-Force Left	15-	•
550	Z-Force Left	15-	•

					
	800	Z-Force EX Left	15-	•	
<b>HONDA</b>					
CB	125	F	15-	•	
CA	250	Rebel	90-	•	
<b>HYOSUNG</b>					
GV	300		16-		•
<b>JINCHENG</b>					
JC	125	2A/3A	97-	•	
<b>KAWASAKI</b>					
BN	125	Eliminator A3	00-	•	
	250	Versys-X	17-		•
EX	250	R Ninja	08-12	•	•
EX	250	SL Ninja	15-	•	•
Z	250	SL	15-	•	•
EX	300	R Ninja, ABS	13-	•	•
KLF	300	Bayou Right	89-05	•	
Z	300		15-	•	•
KLF	400	Bayou Right	93-99	•	
KLR	650		08-		•
KVF	650	Brute Force 4x4i Right	05-	•	
KRF	750	Teryx 4x4 Right	08-	•	
KVF	750	Brute Force 4x4i Right	05-	•	
	800	Mule Pro FX Right	15-	•	
KRF	800	Teryx BEF/CEF/DEF Right	14-	•	
KRT	800	Teryx4 BEF/CEF/DEF Right	14-	•	
<b>KREIDLER</b>					
	125	Florett D	07-	•	
	125	Florett RMC-F	07-	•	
<b>KYMCO</b>					
S	250	People Right	06-	•	
<b>MOTOR UNION</b>					
HK	250	Haoke	97-	•	
<b>MZ</b>					
	125	SM, SX	99-		•
RT	125		06-	•	•
<b>SUZUKI</b>					
UH	200	Burgman	14-	•	
LTF	300	King Quad Right	02-	•	
LTR	450	Right	06-	•	
LT-A	500	FY Quadmaster Right	00-	•	
LTF	500	F Left	98-	•	
DR	800	S, Big	91-95		•
DR	800	ST Big	96		•
AN	400	Burgman Right	07- 16	•	
AN	400	Burgman Right	17-	•	
<b>TRIUMPH</b>					
	750	Daytona	91- 92		•
	750	Trident Right	91-	•	
	900	Daytona	91- 94		•
	900	Daytona Super III	94-		•
	900	Bonneville	05- 08		•
	900	Daytona, Sprint	94-		•
	900	Daytona, Sprint Right	93	•	
	900	Speed Triple	94- 96		•
	900	Tiger Right	93- 98	•	
	900	Trident Right	91-	•	
	900	Trophy Right	91- 95	•	
	900	Trophy	96-		•



	955	Tiger		04- 06		•
	1000	Daytona		92		•
	1000	Trophy Right		91- 95	•	
	1050	Tiger		07-		•
	1050	Tiger SE (Rad.cal)		09-		•
	1200	Daytona		91-		•
	1200	Trophy		96- 03		•
	1200	Trophy Right		91- 95	•	

**VOXAN**

	1000	Scrambler		01- 03		•
--	------	-----------	--	--------	--	---

**YAMAHA**

FZR	50			90-		•
TZM	50	R		94-		•
TZR	50			90- 02		•
YBR	250			07-		•
YFZ	450	S Left/Rear		04-09		•
YXR	450	Rhino Right		06-		•
	660	Rhino Right		05-		•
YFM	700	R Raptor Right		06-08		•
YFM	700	Raptor		09-		•
YXR	700	Rhino Left		08-		•
XTZ	750	Super Tenere Right		89-95		•
XTZ	750	Super Tenere Left/Rear		89- 95		•

# 3065 ORGANIC

## Brake Pads

A 49,0 | L 31,6 | S 7

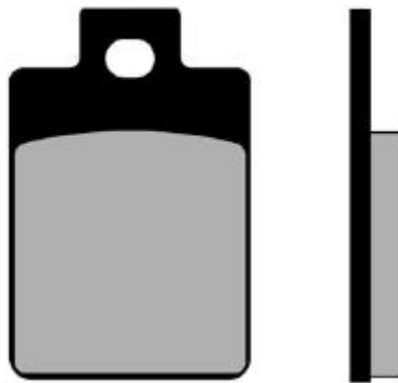

### GILERA

	50	Easy Moving	96-	•
	50	Typhoon	96-	•
	125	Typhoon	96-	•

### PIAGGIO

	25	Zip II Cat DT	01-	•
	50	Free (Disc Brake version)	93- 96	•
	50	Storn	96-	•
	50	Typhoon	96-	•
	50	Zip II	01-	•
	50	Zip II Cat DT	01-	•

NRG	50		96- 00	•
-----	----	--	--------	---

NTI	50		96-	•
-----	----	--	-----	---

RST	50	Sfera	95-	•
-----	----	-------	-----	---

TPH	50		96-	•
-----	----	--	-----	---

	80	Skipper	96-	•
--	----	---------	-----	---

	80	Typhoon	96-	•
--	----	---------	-----	---

	125	Skipper	96- 98	•
--	-----	---------	--------	---

	125	Typhoon	96-	•
--	-----	---------	-----	---

TPH	125		96-	•
-----	-----	--	-----	---

### PUCH

	50	Typhoon (Austria)	96-	•
--	----	-------------------	-----	---

	125	Typhoon (Austria)	96-	•
--	-----	-------------------	-----	---

# Brake Pads

3067 ORGANIC  
4067 SINTERED

A 56,3 | L 39,5 | S 8,0

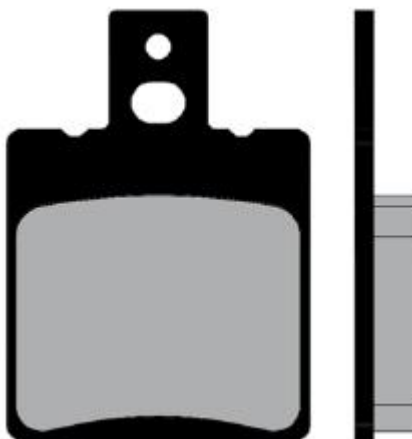

## APRILIA

SR	50	WWW, Netscaper	97-	•
	125	Leonardo	97- 98	•
	150	Leonardo	97- 98	•

## HONDA

CRM	125	R	90- 98	•
NSR	125	F, R	90- 92	•
NSR	125	R, Italy	89-	•



# Brake Pads

3069 ORGANIC  
4069 SINTERED

A 42,0 | L 77,0 | S 7,2

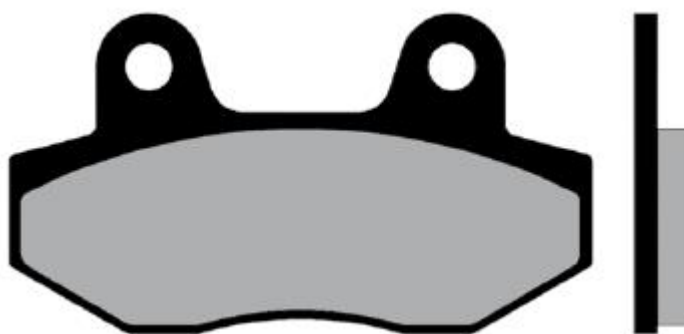

## BETA

R	150		10-	•
---	-----	--	-----	---

## CAGIVA

	50	Mito	99-	•
	125	Stella	97-	•

## DAELIM

	110	City Ace	03-	•
--	-----	----------	-----	---

## FACTORY

YR	125		06-	•
----	-----	--	-----	---

## GARELLI

		Xo Electric	12-	•
	125	Joker 2	02-	•
	150	Joker 2	02-	•
	125	Flexi	12-	•
	125	Xo	12-	•
	150	Xo	12-	•

## HONDA

MBX	50	S	83- 85	•
NS	50	F, Aero	88-	•
NS-1	50		91-	•
NSR	50		89- 90	•
NSR	75	FII	88- 00	•
NSR	80	R	87- 92	•
MBX	80		83- 86	•
MBX	80	DX	82-	•
MBX	80	SW, SWD	83-	•
CBX	125	Custom	88	•
FS	125	Sonic	03-	•
MBX	125	RWB	84-	•
CB	250	Rebel	86-	•
CMX	250	Rebel	85-	•

**HYOSUNG**

	125	Boomer	03-		•
	125	Exceed	02-		•
	125	Grand Prix Plus	02-	•	
GT	125	Comet	02- 03	•	
GV	125	Aguila	02- 04	•	
RT	125	Karion	02- 06	•	
RX	125		00-	•	
XRX	125	Offroad	99- 06	•	
GT	125		07-	•	•
GT	125	Comet	04-	•	•
GT	125	Naked	13-	•	•
GT	125	RSupersport	07-	•	•
GV	125	Aguila	05-	•	
RT	125	Karion	07-	•	•
RX	125	SM	07-	•	•
XRX	125		07-	•	•
	150	Exceed	02-		•
GT	250	Comet	03-	•	•
GT	250	iR	13- 14	•	•
GT	250	P	13-	•	•
GT	250	R	07-	•	•
GV	250		02-	•	
XRX	400		05-	•	
	600	Comet	03	•	
GV	650	Aguila	04- 05	•	
GT	650		04-	•	•
GT	650	i	13-		•
GT	650	iNaked	15-		•
GT	650	iR	13- 14		•
GT	650	P	16-	•	•
GT	650	R	05-	•	•
GT	650	S	05-	•	•
GT	650	TTC	07-	•	•
GT	650	TTC/ Custom Trendkiller	07-	•	•
GT	650	X	07-	•	•
GV	650	Aguila	06-	•	•
ST	700		11-		•
ST	700	i Deluxe	13-		•

**ITALJET**

	50	Rollercraft	08-	•	
	125	Torpedo	08-	•	
	150	Torpedo	08-	•	
	650	Bazooka	06-	•	•
	650	Grifon	06-	•	•

**KEEWAY**

RY8	50		10-		•
-----	----	--	-----	--	---

**KYMCO**

	50	Nexxon	08-	•	•
	100	Spike	02-	•	
	110	Spike	03-	•	
	125	Jetix	08-	•	
	125	Nexxon	08-	•	•
	125	Spike	02-	•	
CK	125		04- 13	•	
DX	150	Custom	93-	•	



NSR	150		93-	•	
	150	Straight	08-	•	•
<b>MASH</b>					
	125	Cafe Racer	14-	•	
	125	Seventy Five	14-	•	
	250	Cafe Racer	14-	•	
	250	Two Fifty	14-	•	
<b>MEGELLI</b>					
	125	M, R, S	08-	•	
<b>MZ</b>					
	125	Mantizz S	07-	•	
<b>PEUGEOT</b>					
	50	Speedfight 3 (AC)	10-	•	
	50	Speedfight 3 (LC)	10-	•	
	50	Speedfight 3 RS (LC)	10-	•	
	50	Speedfight 4 (AC)	15-	•	
	50	Speedfight 4 (LC)	15-	•	
<b>SACHS</b>					
	50	MadAss	04-	•	
	50	MadAss4T	05-	•	
	125	MadAss	09-	•	
<b>SYM</b>					
	125	Wolf Legend	02-	•	
	125	Wolf Classic	05-	•	

# Brake Pads

3070 ORGANIC  
4070 SINTERED

A 42,0 | L 96,5 | S 9,0  
A 42,0 | L 77,0 | S 9,0

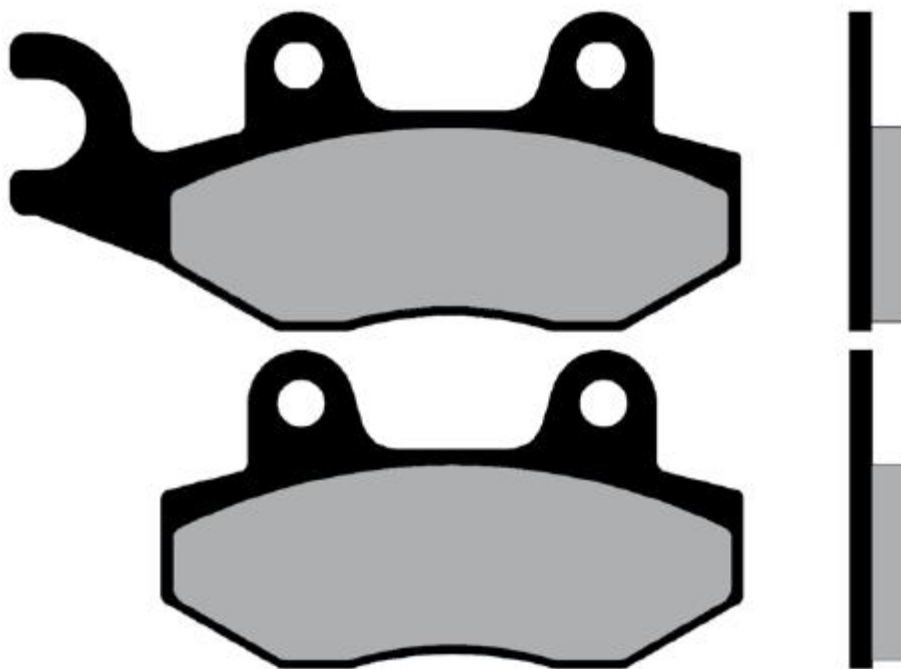

## AEON

125	Elite	13-	•
125	Urban	11- 13	•
250	Elite	11-	•
350	Urban	11-	•
400	Elite	13-	•

## BENELLI

350	Zenzero	12-	•
-----	---------	-----	---

## DAELIM

50	a Four	06-	•
125	Delfino	08-	•

## GENERIC

125	Zion	08-	•
-----	------	-----	---

## HONDA

CA	125 Rebel	95- 96	•
CMX	250 CRebel	96-	•

## JINCHENG

JC	250	06-	•
----	-----	-----	---

## KEEWAY

125	Superlight	06-	•
150	Superlight	06-	•
250	Land Cruiser	06-	•

## KREIDLER

125	Enduro	07-	•
125	Supermoto	07-	•
200	Enduro	07-	•



**KYMCO**

	50	Agility	05- 08	•
	50	Agility (4T) R10	06-	•
	50	Agility (4T) R12	06-	•
	50	Filly LX	02-	•
	50	New Sento	11-	•
	50	Sento	08- 10	•
	50	Vitality	04-	•
	50	YupSP/AL	02-	•
RS	50	Agility Naked	10-	•
	125	Agility	06-	•
	125	Agility City	11-	•
	125	Like	11-	•
	125	Stryker on/off	99-	•
	125	Vivio	01-	•
	150	Stryker Off	01-	•
	150	Vivio	01-	•
	300	People Si Left/Rear	08-	•

**MALAGUTI**

	125	Blog	10-	•
	125	Centro ie	08- 11	•
	160	Blog	10-	•
	160	Centro ie	08- 11	•

**MZ**

	125	SM, SX	02-	•
--	-----	--------	-----	---

**PGO**

	125	I-Charge Fuel Injection	03-	•
--	-----	-------------------------	-----	---

**QUINGOI**

QM	125	GY	02-	•
----	-----	----	-----	---

**TGB**

	50	203	05-	•
	50	Akros tec 5	99- 04	•
	50	Apollo	99-	•
	50	Fire, Sky	03-	•
	90	Apollo	99-	•
	250	Dynasty	06-	•

# Brake Pads

3071 ORGANIC  
4071 SINTERED

A 39,0 | L 102,0 | S 9,8

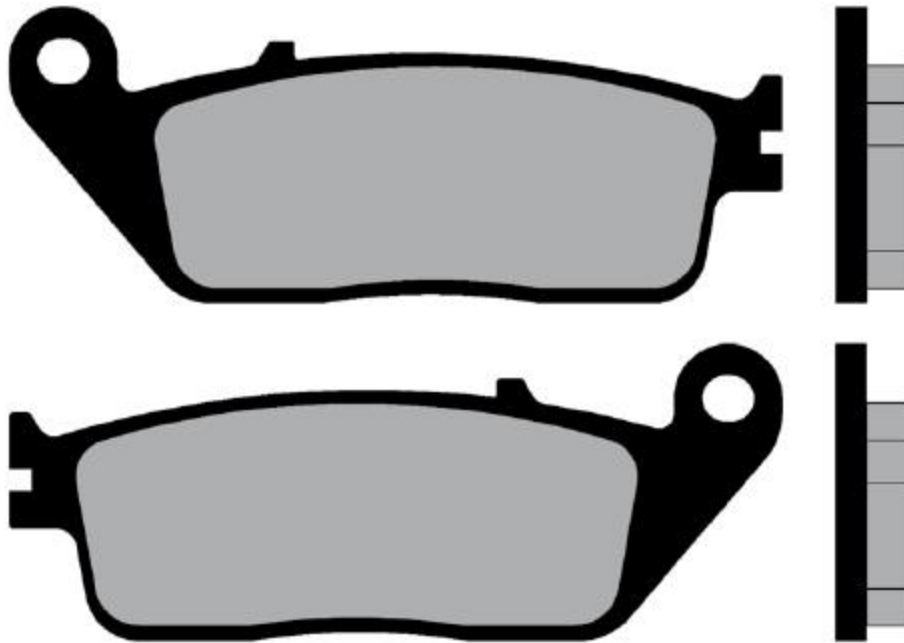







## DAELIM

	125	Roadwin	04-	•
	125	Rocket	99-	•
VL	125	Daystar	00-	•
VT	125	Evolution	00-	•
VT	125	Magna	97-	•
	250	Roadwin	08-	•

## HONDA

VIR	250		98- 02	•
	300	Rebel	17-	•
CBR	300	F	14-	•
CBR	300	R	15-	•
CB	400	Super Four	92- 95	•
VRX	400	T Roadstar	95-	•
	500	Rebel	17-	•
CB	500	F	13-	•
CB	500	X	13-	•
CBF	500		04- 08	•
CBR	500	R	13-	•
XL	600	V, Transalpino	94- 96	•
CB	650	F	14-	•
CBR	650	F	14-	•
CBR	650	F ABS	14-	•
NTV	650		94-	•
DN-01	680		08-	•
CIX	700		14-	•

					
CIX	700	D ABS w/DCT	14-	•	
CIX	700	N	14-	•	
CIX	700	ND ABS w/DCT	14-	•	
NC	750	D Integra	14-	•	
NC	750	S w/DCT	14-	•	
NC	750	X w/DCT	14-	•	
NM4	750	Vultus ABS w/DCT	15-	•	
VT	750	Black Widow	01- 03	•	
VT	750	C2 Shadow A.C.E.	97- 03	•	
VT	750	C2 Shadow Spirit	07- 11	•	
VT	750	C2B	11-	•	
VT	750	C4 Shadow	04-	•	
VT	750	RS	11-	•	
VT	750	S	11-	•	
VF	750	C, CD Magna	94- 98	•	
VFR	750	F	88- 98		•
VFR	950	F, Carat	92-		•
CBF	1000		06- 11	•	
CBF	1000	Limited Edition	09- 14	•	
CBR	1000	F	89- 92		•
VFR	1000		89		•
ST	1100		90- 02		•
ST	1100	ABS/TCS	92- 95		•
CTX	1300		14-		•
GL	1500	F6 C Valkyrie	96- 02		•
<b>INDIAN</b>					
	1800	Chief Classic	14-		•
	1800	Chief Vintage	14-		•
	1800	Chieftain	14-		•
	1800	Dark Horse	16-		•
	1800	Roadmaster	15-		•
	1800	Springfield	16-		•
<b>TRIUMPH</b>					
	900	Adventurer	96-		•
	900	Legend TT	99-		•
	900	Thunderbird	96-		•
	900	Thunderbird Sport	03-		•
	900	Tiger	99- 00		•
<b>VICTORY</b>					
	1634	Hammer	08		•
	1634	Kingpin all models	08-		•
	1634	Vegas	08-		•
	1634	Vegas 8-Ball	08-		•
	1634	Vegas Jackpot	08		•
	1731	Boardwalk	13-		•
	1731	Cross Country	10-		•
	1731	Cross Country 8-Ball	14-		•
	1731	Cross Country Tour	12-		•
	1731	Cross Roads	10-		•
	1731	Cross Roads 8-Ball	14-		•
	1731	Cross Roads Classic	14-		•
	1731	Gunner	15-		•
	1731	Hammer	09-		•
	1731	Hammer	10-		•
	1731	Hammer S	09-		•
	1731	Hard-Ball	12-		•
	1731	High-Ball	12-		•
	1731	Jackpot	10-		•
	1731	Judge	13-		•



1731	Kingpin	10-	•
1731	Kingpin 8-Ball	10-	•
1731	Magnum	15-	•
1731	Magnum X-1	15-	•
1731	Vegas	10-	•
1731	Vegas 8-Ball	10-	•
1731	Vegas Jackpot	09-	•
1731	Vision all models	08-	•

**YAMAHA**

VP	125	X-City	08-	•
YP	125	X-Max	10-	•
YP	125	X-Max ABS	11-	•
YP	125	X-Max Business ABS	11-	•
YP	125	X-Max Sport Ed.	11-	•
VP	250	X-City	07-	•
YP	250	X-Max	10-	•
VP	300	Versity	05- 06	•
YP	400	RX-Max	13-	•
YP	400	RAX-Max	14-	•
MT-01	1700	(Rad.cal)	05-	•



# Brake Pads





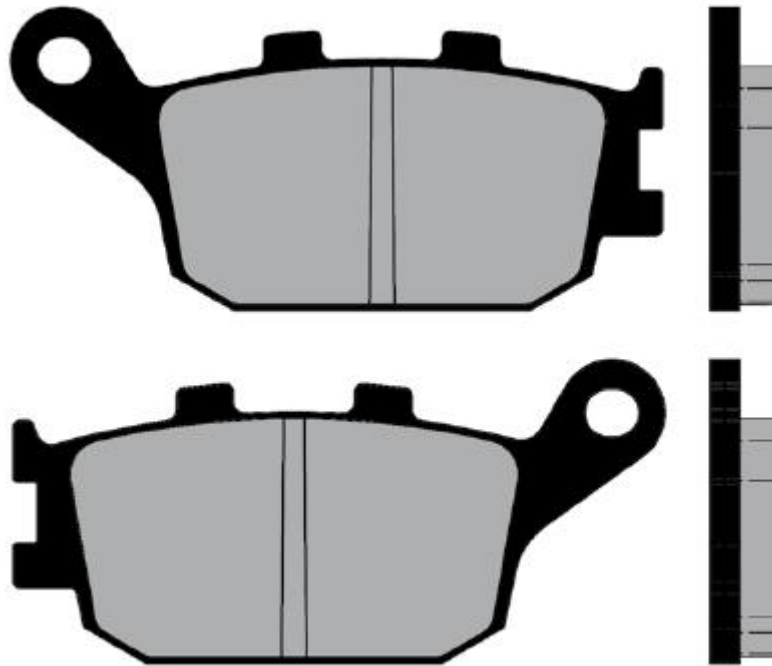

3072 ORGANIC  
4072 SINTERED

A 40,0 | L 86,0 | S 9,0



## HONDA

NSS	250		00- 04	•
NSS	250	Forza	00- 04	•
NSS	250	Jazz	01- 04	•
CBR	400	F	92-	•
CBF	500		04- 08	•
CBF	500	ABS	04- 08	•
CB	600	Hornet	98- 06	•
CB	600	Hornet (Japan)	98- 99	•
CB	600	HornetABS	07- 12	•
CB	600	HornetS	00- 03	•
CBF	600	N	04- 11	•
CBF	600	NABS	08- 11	•
CBF	600	S	04- 11	•
CBF	600	SABS	08- 11	•
CBR	600	F ABS	11-	•
CBR	600	F, Super Sport	91- 94	•
CBR	600	F3	95- 98	•
CBR	600	F4, F4 Sport	99- 06	•
CBR	600	RR	03- 04	•
CBR	600	RR (Rad.cal)	05- 06	•
FMX	650		05- 08	•
NT	650	VDeauville	01	•
NC	700	D Integra	12- 13	•
NC	700	SAABS	12- 13	•
NC	700	SDABS	12- 13	•

					
NC	700	XA ABS	12- 13		•
NC	700	XD ABS	12- 13		•
XL	700	Transalp ABS	08-		•
CB	750	N, F, Seven Fifty	92- 95		•
NR	750		92-		•
CB	900	Hornet	02- 07		•
CBR	900	RR Fireblade	92- 03		•
CB	1000	F (Big One)	93- 97		•
CBF	1000		06- 11		•
CBF	1000	F ABS	15-		•
CBF	1000	Limited Edition	09- 14		•
CBR	1000	RR Fireblade (Rad.cal)	04- 05		•
VIR	1000	F Firestorm	97- 07		•
VIR	1000	SP-1, SP-2	00- 06		•
CB	1100	EX	14- 16		•
CB	1100		13		•
CB	1100	EX	17-		•
CB	1100	RS	17-		•
VT	1100	C2 Shadow A.C.E.	95-		•
VT	1100	C2Y	00-		•
VT	1100	C3 Shadow Aero	98-		•
VT	1100	T Shadow	98-		•
CB	1300		05-		•
CB	1300	S	11-		•
VT	1300	CXA Fury	10- 12		•
VIX	1300	C	04- 09		•
VIX	1300	S	03- 07		•
<b>KAWASAKI</b>					
	650	Ninja	17-		•
EN	650	Vulcan S	15-		•
EN	650	Vulcan S Cafe	17-		•
EN	650	Vulcan SSE	17-		•
Z	650		17-		•
Z	750	ABS	07- 12		•
	1000	Versys	12-		•
	1000	Versys ABS	15- 16		•
	1000	Versys LT	15-		•
KLV	1000	Left/Rear	04- 07		•
Z	1000	(Rad.cal)	10- 13		•
Z	1000		07- 09		•
<b>SUZUKI</b>					
DL	250	V-Strom	17-		•
GSX-R	250		17-		•
GW	250	Inazuma	12-		•
GW	250	Inazuma F	15-		•
DL	650	V-Strom Left/Rear	04- 13		•
DL	650	V-Strom Left/Rear	17-		•
DL	650	V-Strom XT Left/Rear	15- 16		•
DL	650	V-Strom XT Left/Rear	17-		•
GSF	650	Bandit	07-		•
GSF	650	Bandit / S Bandit Left/Rear ABS	06		•
GSF	650	Bandit ABS	07- 12		•
GSF	650	S Bandit	07-		•
GSF	650	S Bandit ABS	07- 13		•
GSX	650	F	08- 13		•
SV	650	S Left/Rear	03- 12		•
GSR	750	Left/Rear	11-		•
GSX-S	750		17-		•
GSX-S	750	Left/Rear	15- 16		•



GSXS	750	Z Left/Rear	15- 16	•
DL	1000	V-Strom Left/Rear	02- 13	•
GSX-S	1000		15-	•
GSX-S	1000	F	15-	•
SV	1000	S	03- 07	•
GSF	1200	Bandit	06	•
GSF	1200	S Bandit	06	•
GSF	1250	A Bandit	07-	•
GSF	1250	Bandit	06-	•
GSF	1250	F Bandit	12-	•
GSF	1250	S Bandit	06-	•
GSF	1250	SA Bandit	07-	•
GSX	1250	FA Bandit	16-	•
GSX	1250	FA Traveller	15-	•
	1300	B-King	07	•
<b>YAMAHA</b>				
FZ6	600		04-	•
FZ6	600	Fazer	04-	•
FZ6	600	Fazer S2	07-	•
FZ6	600	Fazer S2 ABS	07-	•
FZ6	600	S2	07-	•
FZ6	600	S2 ABS	07-	•
XJ6-F	600		13-	•
XJ6-N	600		13-	•
XJ6-S	600		13-	•
YZF	600	R6	03- 04	•
YZF	600	R6 (Rad.cal)	05- 16	•
MT-07	700		14-	•
MT-07	700	Moto Cage	15-	•
MT-07	700	Tracer	16-	•
XSR	700		16-	•
	800	Fazer 8	10-	•
FZ8	800		10- 14	•
MT-09	900	(Rad.cal)	14-	•
MT-09	900	Sport Tracker (Rad.cal)	15-	•
MT-09	900	Street Rally (Rad.cal)	14-	•
MT-09	900	Tracer (Rad.cal)	15-	•
XSR	900		16-	•
FZ1	1000	Fazer	06-	•
MT-10	1000		16-	•
MT-10	1000	SP	17-	•
YZF	1000	R1 (Rad.cal)	04- 06	•
YZF	1000	R1 (Rad.cal) (4-pad)	07- 14	•
YZF	1000	R1 (Rad.cal) (4-pad) ABS	12- 14	•
YZF	1000	R1 SP (Rad.cal)	06	•

# Brake Pads

3073 ORGANIC  
4073 SINTERED

A 40,0 | L 86,0 | S 10,5

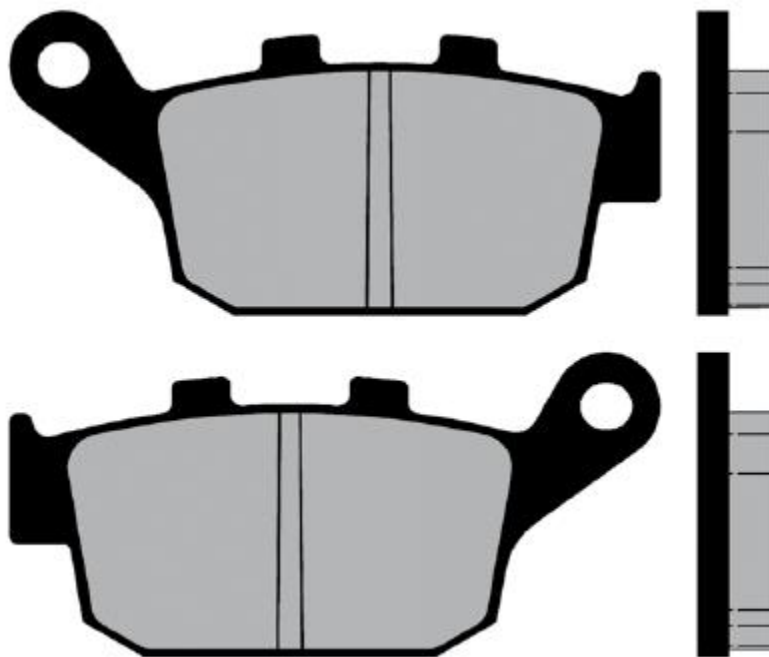







## BUELL

	500	Blast	01-09	•
XB9R	984	Firebolt	02-10	•
XB9S	984	Lightning	03-10	•
XB9SX	984	CityX	05-10	•
M2	1200	Cyclone	98-02	•
S1	1200	Lightning	98-02	•
S1	1200	Whitelighting	98-02	•
S3	1200	Thunderbolt	98-02	•
X1	1200	Lightning	01-02	•
XB12R	1200	Firebolt	04-08	•
XB12R	1200	Firebolt	09-10	•
XB12S	1200	Lightning	04-08	•
XB12Scg	1200	Lightning	06-08	•
XB12Scg	1200	Lightning	09-10	•
XB12Ss	1200	Lightning Long	06-08	•
XB12Ss	1200	Lightning Long	09-10	•
XB12STT	1200	Super TT	07-10	•
XB12X	1200	Ulysses	06-10	•

## HONDA

FES	125	Pantheon	03-06	•
FES	150	Pantheon	03-06	•
CBR	250	Hurricane	87-	•
CBR	250	R, RR	90	•
CBR	250	RJ	88	•
FES	250	Foresight	00-07	•

					
NSR	250	R, SP	90		•
NSR	250	RJ	88-		•
RS	250	R	91- 92		•
VT	250	Spada	89		•
VIR	250		98- 02		•
CB	400	Super Four	92- 95		•
CB-1	400	(CB 400 F)	89- 90		•
CBR	400	RR	87- 89		•
NTV	400	Bros II	88		•
VFR	400	R	87- 88		•
VRX	400	T Roadstar	95-		•
NX	500	Dominator (Austria)	88- 96		•
NTV	600	Bros I	88-		•
NTV	600	Revere	88- 92		•
XL	600	V,Transalpino	91- 99		•
NT	650	Hawk GT	88- 91		•
NT	650	V Deauville	98- 00		•
NTV	650		94-		•
NTV	650	Bros	88- 97		•
NTV	650	Revere	88- 93		•
NX	650	Dominator	93- 96		•
NX	650	Dominator J-K	88- 92		•
XL	650	V Transalp	00- 07		•
XRV	650	Africa Twin	88- 89		•
NC	700	S	12- 13		•
NC	700	X	12- 13		•
VFR	700	F Interceptor	88- 89		•
XL	700	Transalp	08- 11		•
XRV	750	Africa Twin	90- 03		•
<b>MOTO-GUZZI</b>					
	1000	Quota	92		•
<b>SUZUKI</b>					
XF	650	Freewind	97- 02		•
<b>TRIUMPH</b>					
	600	Daytona	03- 04		•
	600	Speed Four	03- 06		•
TT	600		00- 03		•
	650	Daytona	05- 06		•
	675	Daytona (Rad.cal)	06- 08		•
	675	Daytona R Triple (Rad.cal)	11- 12		•
	675	Daytona Triple (Rad.cal)	09- 12		•
	675	Street Triple	08- 12		•
	675	Street Triple R	09- 12		•
	800	Tiger	11- 14		•
	800	Tiger XC	11-		•
	800	Tiger XC ABS	12- 14		•
	800	Tiger XCA	15-		•
	800	Tiger XCR	15-		•
	800	Tiger XR	15-		•
	800	Tiger XRT	15-		•
	800	Tiger XRX	15-		•
	955	Daytona from VIN 132513	99-		•
<b>YAMAHA</b>					
FZ6R	600		09-		•
XJ6	600	Diversion	09-		•
XJ6-F	600		09- 12		•
XJ6-N	600		09- 12		•
XJ6-S	600		09- 12		•

# 3074 ORGANIC

## Brake Pads

A 42,8 | L 85,0 | S 7,0  
A 37,0 | L 47,3 | S 9,0

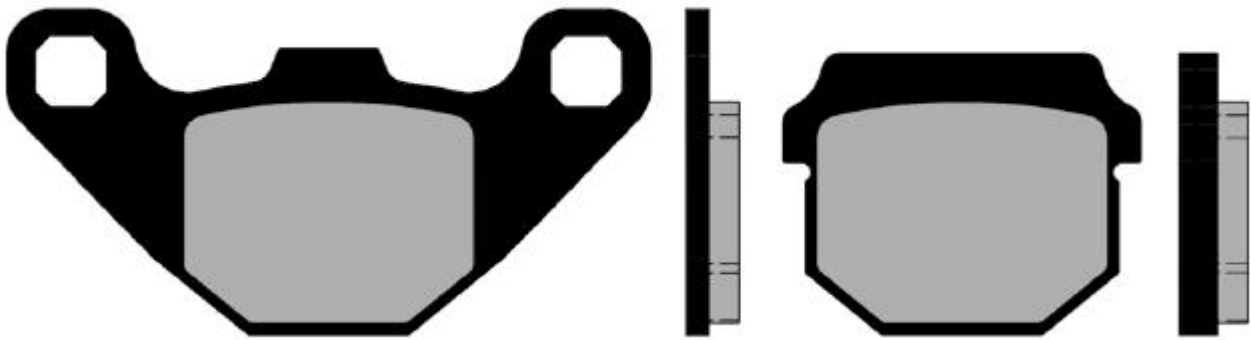

### ADLY

150	ATV	05-	•	•
150	Interceptor	05-	•	•
300	ATV	05-	•	•







### AEON







50	Aero	06-	•	
50	Regal	06-	•	
50	Torch	06-	•	
90	Regal	06-	•	
100	Pulsar	06-	•	
110	Aero	06-	•	
110	Pulsar	06-	•	
100	Revo 2	04-		•
125	Co-In	14-	•	
125	Elite	13-		•
125	Urban	11- 13		•
125	Pulsar	06-	•	
150	Pulsar	06-	•	
250	Elite	11-		•
350	Urban	11-		•
400	Elite	13-		•

### APRILIA







RS-4	50		12-	•
RS-4	50	Replica	16-	•
SX	50	Ltd.	14	•
	125	Tuono ABS	17-	•
RS-4	125	(I.Juan cal.)	11-	•
RS-4	125	Replica, ABS	16-	•
RX	125	Enduro	08-	•
RX	125	Supemotard	08-	•

### BENELLI

					
	350	Zenzero	12-		•
<b>BOMBARDIER</b>					
	200	Rally 2x4	03- 06		•
<b>CAN-AM</b>					
DS	90	X	08-		•
<b>CECTEK</b>					
	500	EFI Gladiator	09-		•
	500	EFI King Cobra	09-		•
	500	EFI Quadrift	09-		•
	500	i Estoc	10-		•
<b>CPI</b>					
	50	Baby	02		•
	50	Hussar	01- 02		•
	50	Mars	01-		•
	50	Popcorn	01- 02		•
XS	250	Quad	06-		•
<b>DAELIM</b>					
ST	250	Sector Quad	05- 06		•
<b>DERBI</b>					
DXR	200	Quad (Front disc)	04-		•
DXR	250	Quad (Front disc)	04-		•
<b>E-TON</b>					
VXL	250	Vector,ST Vector	06-		•
VIX	300	Vortex,ST Vortex	07-		•
VXL	300	Vector,ST Vector	07-		•
<b>FACTORY</b>					
	50	Helix	04-		•
	50	Rex	04-		•
	100	Helix	04-		•
	100	Rex	04-		•
<b>FANTIC</b>					
	50	Regolama Casa	08-		•
	50	Supersei Motard	08-		•
	125	Regolama Casa	08-		•
	125	Supersei Motard	08-		•
<b>GARELLI</b>					
	125	Raider	02-		•
<b>HYOSUNG</b>					
	50	Avanti	99-		•
	50	Rush	97-		•
	50	Sense	98-		•
	50	Super Cab	95-		•
	50	Super Cab Plus	98-		•
SB	50		00-		•
SB	50	P	00-		•
SD	50		00-		•
SF	50		99-		•
	100	Cab	98-		•
EZ	100		00-		•
	110	Midas Plus	98-		•
FX	110	110	02-		•
KR	110	Master	04-		•
GD	125	EXIV	12-		•
<b>ITALJET</b>					
	100	Millennium 2T	01-		•
	125	Millennium	00-		•
	150	Millennium	00-		•
<b>KAWASAKI</b>					
AR	50		81- 82		•

					
KMX	50		88-	•	
KSR	50	I (50)	90- 91	•	•
AR	80		81-	•	
KD	80		88- 90	•	
KSR	80	II (80)	90- 91	•	•
KX	80		84- 87	•	
KX	80		88- 96	•	
KX	100		88- 92	•	
KX	100		95- 96	•	
KDX	125		90- 94	•	
KMX	125		86	•	
KX	125		82	•	
ZL	125	Eliminator	97-	•	
KMX	200		88- 90	•	
KX	250		82	•	
KXT	250	Tecate	84		•
<b>KEEWAY</b>					
	50	Flash	07-	•	
	50	Hurricane	06-	•	
	90	Hurricane	06-	•	
<b>MAICO</b>					
	50	Cruiser	99-	•	
	50	Thunderbike I	99-	•	
	50	Thunderbike II	99-	•	
C-1	50	Hard Enduro	99-	•	
R-1	50	Superbike	99-	•	
X-1	50	SuperCross	99-	•	
<b>MZ</b>					
	50	(MUZ) MoskitoSX	00-	•	
<b>PETERSON</b>					
	50	Hurricane	95-		•
SR	50	Racing	95-		•
	80	Hurricane	95-		•
SR	80	Racing	95-		•
<b>PGO</b>					
	50	Big Max	03-	•	
	50	Comet	91-	•	
	50	Galaxy	91-	•	
	50	Road 66	95-	•	
PS	50		93	•	
	50	X-Rider	03-		•
	90	Galaxy	92-	•	
	125	X-Rider	03-		•
	150	X-Rider	03-		•
<b>PIAGGIO VESPA</b>					
	50	New Liberty S	16-	•	
	50	Typhoon	06-	•	
NRG	50	PowerDD	06-	•	
NRG	50	Purejet	06-	•	
<b>POLARIS</b>					
	200	Phoenix	05- 09	•	
	200	Sawtooth	06-	•	•
<b>QUADRO</b>					
	350	3	16-		•
	350	4	16-		•
D	350		11- 15		•
<b>RIEJU</b>					
RS2	50	NKD	06-		•
RS3	50		12-		•



					
RS2	125	NKD	06-		•
RS2	125	Pro	08-		•
<b>ROXON</b>					
	150	Quad Sport Spirit	06-		•
<b>SULA</b>					
	50	Thunder Bird	99-		•
	100	Thunder Bird	99-		•
	125	Thunder Bird	99-		•
<b>SUZUKI</b>					
AE	50	R/L	88-		•
AH	50	Adress	92- 95		•
CP	50		85-		•
CR	50	DC	87-		•
ZZ	50	Scooter	92-		•
CC	50	Tune	92-		•
LIDO	75	Style			•
RM	80		90- 95		•
RM	80		96- 01		•
ZZ	80	Sepia	90-		•
AH	80	Adress, V, Tune	88-		•
RM	85	L	02- 04		•
AH	100	V Adress	91- 94		•
UK	110	Adress	15-		•
AN	125		06- 08		•
LIDO	125	Vario Scooter	90-		•
UE	125		01-		•
UE	150	CT	02-		•
<b>TGB</b>					
		309 Racing	05-		•
		309 RS	00-		•
		507	05-		•
		Double X	05-		•
		J409	00-		•
	50	101R	05- 09		•
	50	101S	99-		•
	50	202T	99-		•
	50	303R	99-		•
	50	Akros	99-		•
	50	Bull&tRS/RR	11-		•
	50	Bullet	09-		•
	50	Bunny	97-		•
	50	Ergon	96-		•
	50	Hawk	09-		•
	50	Hiw's	99-		•
	50	Hook	10-		•
	50	Tapo RS	11-		•
	50	Trigger	99- 03		•
R	50	X	06-		•
	90	101S	99-		•
	90	202T	99-		•
	90	Akros	99-		•
	90	Ergon	99-		•
	90	Hiw's	99-		•
	90	Trigger	99-		•
	125	101S	99-		•
	125	202T	99-		•
	125	303R	99-		•
	125	Bull&tRS/RR	11-		•
	125	Hook	10-		•



**TM**

80	Junior	96-00	•
----	--------	-------	---

**UVM**

50	BeThere	99-	•
50	Bingo	99-	•
125	BeThere	99-	•
125	Bingo	99-	•
125	Paragon	99-	•

**ZERO**

DS	ZF6.0	10-12	•
DS	ZF9.0	10-12	•
MX		10-12	•
S	ZF6.0	10-12	•
X		10-12	•
XU		11-12	•

# 3075 ORGANIC

## Brake Pads

A 42,8 | L 85,0 | S 7,8  
A 37,0 | L 47,3 | S 10,0



### ADLY

	50	Panther	01-	•	
	50	Silver Fox	06-	•	
	50	Super Sonic	00- 05	•	
	50	Thunderbike	97-	•	
RS	50	Super Sonic	06-	•	•
	100	Panther	01-	•	
	100	Silver Fox	06-	•	
	100	Super Sonic	01- 05	•	
	100	Thunderbike	01-	•	•
	125	Super Sonic	01- 05	•	
	125	Thunderbike	01-	•	•

### EASY RIDER

	50	Easy Rider	99-	•	
--	----	------------	-----	---	--

### GILERA

	50	Eaglet	97-		•
--	----	--------	-----	--	---

### HM

CRE	50		98- 01		•
CRE	50	Baja	97- 01	•	•

### HONDA

MB	80		80-	•	
MCX	80		82-	•	

### KAWASAKI

KMX	80		87-	•	
KMX	125		87- 02	•	

### KREIDLER

	25	Florett XL	99-	•	
	50	Florett	99-	•	

### MALAGUTI

	125	Blog	10-		•
	160	Blog	10-		•



**PEUGEOT**

50	Speedake (Hengtong cal.)	94-	•
50	Speedfight LC,(Hengtong cal.)	96-	•
50	Squab (Hengtong cal.)	94-	•
50	Trekker Offroad	99-	•
50	Vivacity (Hengtong cal.)	05-	•
50	Buxy (Hengtong cal.)	94-	•
50	Kisbee	10-	•
50	Kisbee RS	11-	•
100	Vivacity (Hengtong cal.)	05-	•

**SIAM**

50	Mat	97-	•
100	Mat	97-	•

**SMC**

50	Easy Rider	97-	•
----	------------	-----	---

**SUZUKI**

AJ	50	Sepia	92-	•
AH	80	Scooter	92-	•
RM	80		86- 95	•

# 3076 ORGANIC

## Brake Pads

A 27,6 | L 61,0 | S 7,3



### ADLY

	25	Silver Fox	00- 05	•
	50	Cat	01-	•
	50	Cosy	01-	•
	50	Fox	00-	•
	50	Fox Plus	01-	•
	50	Jet	96-	•
	50	Pista, Pista Twin Light	96-	•
	50	Silver Fox	00- 05	•
RT	50	Road Tracer	02-	•
	70	Fox Plus	01-	•
	70	Pista, Pista Twin Light	01-	•
	80	Cosy	01-	•
RT	90	Road Tracer	02-	•
	100	Cat	01-	•
	100	Jet	96-	•
	100	Silver Fox	01- 05	•

RT	100	Road Tracer	02-	•
----	-----	-------------	-----	---

	125	Cat	01-	•
--	-----	-----	-----	---

### BENELLI

KB-X	50	Race		•
------	----	------	--	---

### BS VILLA







AX	50		93-	•
----	----	--	-----	---

GZ	50		93-	•
----	----	--	-----	---

### CAGIVA

	50	City	08-	•
--	----	------	-----	---

### FANTIC

					
	50	Big Wheel	93-	•	
	50	Grinta	95-	•	
	50	Leader	95-	•	
	50	Pony SR	93-	•	
	50	Queenie	95-	•	
<b>GARELLI</b>					
	50	Starter	02-	•	
CPR	50		02-	•	
FX	50		02-	•	
PMX	50	Rally	00-	•	
SR	50	Pony	95-	•	
<b>ITALJET</b>					
		Yankee 8	94-	•	•
	50	Bazooka	93-	•	
	50	Cruise	95-	•	
	50	Pista 2	92-	•	
	50	Scoop	93-	•	
<b>LEM</b>					
	50	Flash	94-	•	
<b>MBK</b>					
	50	Target	92-	•	
	100	Booster	99- 02	•	
<b>MZ</b>					
	50	(MUZ) Moskito	99-	•	
	125	(MUZ) Moskito	99-	•	
<b>PETERSON</b>					
	50	Hurricane	95-	•	
SR	50	Racing	95-	•	
	80	Hurricane	95-	•	
SR	80	Racing	95-	•	
<b>PEUGEOT</b>					
	50	V-Clic	08-	•	
<b>PGO</b>					
	50	Big Max	94- 02	•	
	50	Big Max Sport	96-	•	
	50	Comet	93-	•	
	50	EPS	96-	•	
	50	Hot	97-	•	
	50	Mega	96-	•	
	50	Tomado	96-	•	
PMX	50		97- 03	•	
	80	Big Max	94-	•	
	90	Big Max	97-	•	
	90	Tomado	00-	•	
	100	Big Max	96-	•	
PMX	110		00-	•	
	125	KungFu			•
	125	Tomado	96-	•	
<b>SHE-LUNG</b>					
	50	Falcon	97-	•	
	125	Mars	97-	•	
<b>SIAMOTO</b>					
	50	Birdie	02-	•	
<b>SULA</b>					
	50	City Bird	99-	•	
<b>TGB</b>					
	250	Dynasty	06-		•
<b>YAMAHA</b>					
	50	Axis Pro Foot	92-	•	



CR	50	Target	91-	•
CR	50	Z	91- 95	•
JOG	50	(Spain)	88-	•
JOG	50	R		•
RS	50	Champ	88-	•
YE	50	Zest (Japan)	92-95	•
JOG-Z	50		88- 89	•
YE	80	Zest (Japan)	93-	•
TZR	80		92-	•
	90	Axis Pro Foot	94-	•
CR	90	Target	91-	•
JOG	90		90-	•
YA	90	Axis	90-	•
YW	100	Booster	99- 02	•

# Brake Pads

3077 ORGANIC  
4077 SINTERED

A 41,2 | L 77,0 | S 9,0

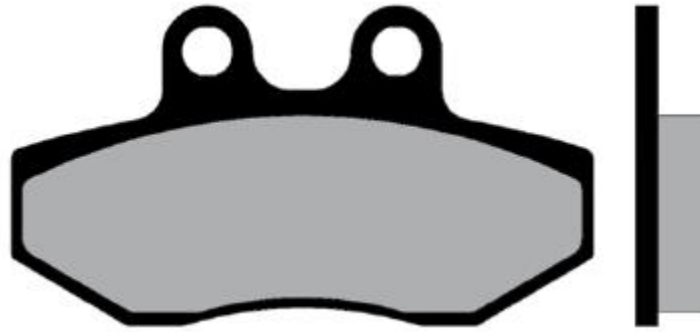

**AJP**

PR4	125	Enduro	04-	•
PR4	125	Supemotard	04-	•
PR4	200	Enduro	04-	•
PR4	200	Supemotard	04-	•

**MBK**

YP	125	FlameX	05-	•
----	-----	--------	-----	---

**SHERCO**

	125		02-	•
	125	City Corp 4T Enduro	03-	•
	125	City Corp 4T SM	03-	•

**TOMOS**

MC	125	T	06-	•
SE	125		05-	•

**YAMAHA**

NXC	125	Cygnus X	05- 09	•
-----	-----	----------	--------	---





# 3079 ORGANIC

## Brake Pads

A 54,5 | L 55,3 | S 7,6

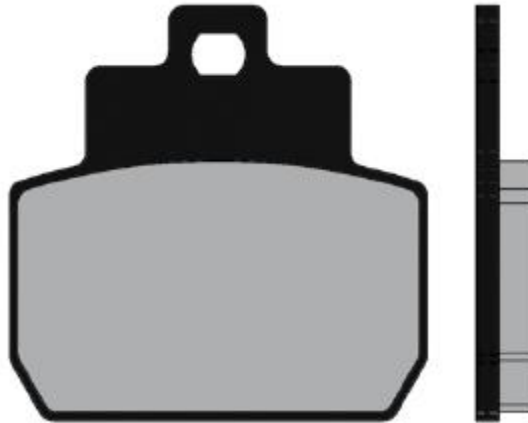

**GILERA**

RC	500	Fuoco ie	08-	•
----	-----	----------	-----	---

**PIAGGIO VESPA**

	125	MP3	06- 07	•
	125	X8	05-	•
	200	X8	05-	•
	250	MP3	06- 07	•
	250	X8	06-	•
	250	X9 Left/Rear	05-	•



3081 ORGANIC  
4081 SINTERED

Brake Pads

A 45,3 | L 118,0 | S 9,0

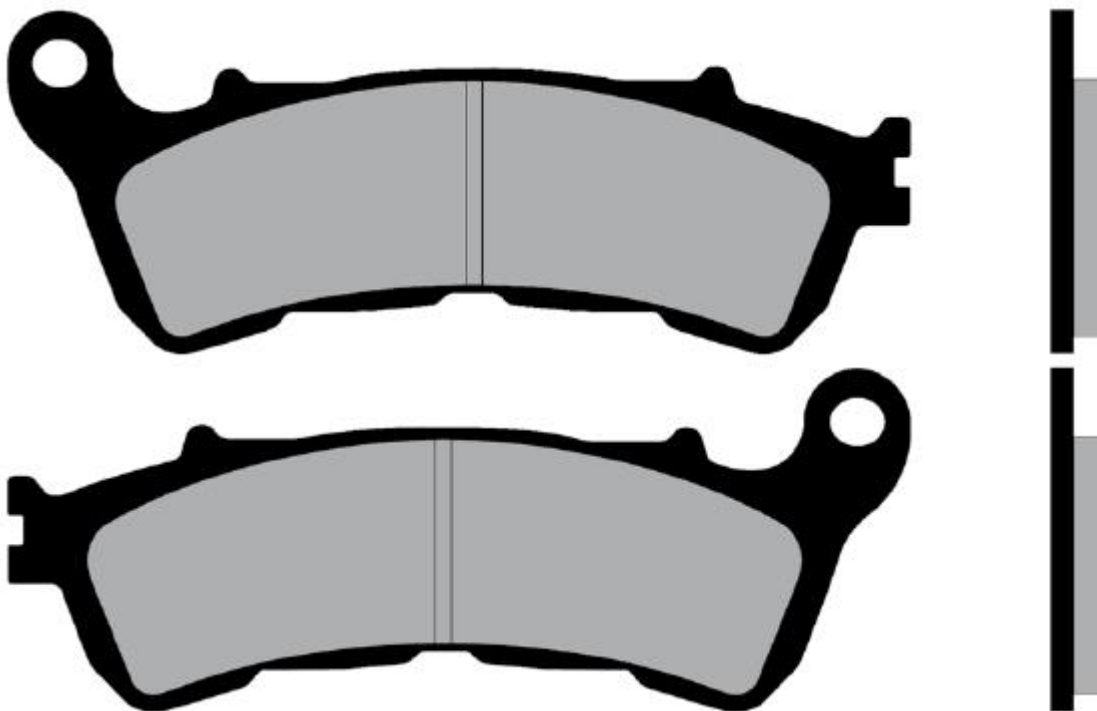

**HONDA**

FES	125	S-Wing	07- 11	•
SH	125	i	09- 12	•
FES	150	S-Wing	07- 11	•
SH	150	i	09- 12	•
CBR	250	R ABS (Nissin cal)	11- 13	•
NSS	250		05-	•
NSS	250	Forza	05- 13	•
PS	250		05-	•
NSS	300	Forza	14-	•
SH	300	i	07-	•
SW-T	400		09- 13	•
SW-T	400	ABS	09-	•
CBF	500	ABS	04- 08	•
CB	600	HometABS	07- 12	•
CBF	600	NABS	08- 11	•
CBF	600	SABS	08- 11	•
CBR	600	F ABS	11-	•
FJS	600	Silverwing	09-	•
SW-T	600		11- 13	•
DN-01	680		08-	•
NC	700	D Integra	12- 13	•
NC	700	SAABS	12- 13	•
NC	700	SDABS	12- 13	•
NC	700	XAABS	12- 13	•
NC	700	XDABS	12- 13	•



NT	700	Deauville ABS	06- 12	•	
NT	700	V Varadero, ABS	10-	•	
XL	700	Transalp ABS	08-	•	
VT	750	C2S ABS	13-	•	
VT	750	CS ABS	13-	•	
	800	Crossrunner	11-	•	
VFR	800	800	06- 13	•	
VFR	800	ABS	06- 13	•	
CB	1000	R ABS	08-	•	
CBF	1000	ABS	06- 11	•	•
CBF	1000	F ABS	15-	•	
CBF	1000	Limited Edition ABS	09- 14	•	•
XL	1000	Varadero	07-	•	
XL	1000	Varadero ABS	04-	•	
CB	1100		13	•	
VFR	1200	XC Crossstourer	12-	•	
VFR	1200	XDC Crossstourer w/DCT	12-	•	
CB	1300	S	11-	•	
CTX	1300		14-	•	
ST	1300	Pan European, ABS	08-	•	
VT	1300	CXAA Fury ABS	10- 12	•	

**SUZUKI**

UH	125	Burgman	07- 16	•	
UX	125	SIXteen	08-	•	
UX	150	SIXteen	08-	•	
UH	200		07-	•	
UH	200	Burgman	07- 13	•	
C	1800	R Intruder	08-	•	

# Brake Pads

3082 ORGANIC  
4082 SINTERED

A 37,4 | L 81,6 | S 9,5

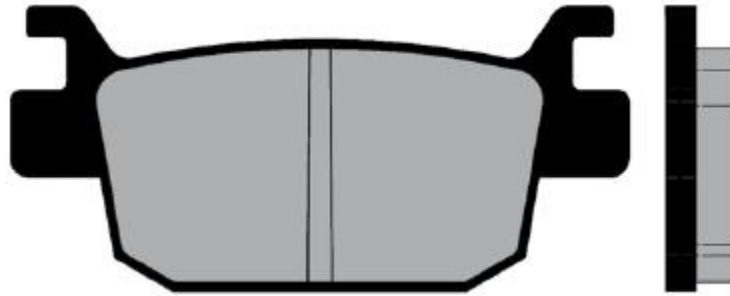

**BENELLI**

BN	302		15-	•
BN	302	Tomado	16-	•

**HONDA**

FES	125	S-Wing	07- 11	•
NSS	125	Forza	15-	•
SH	125		13-	•
SH	125	i	09- 12	•
FES	150	S-Wing	07- 11	•
SH	150		13-	•
SH	150	i	09- 12	•
NSS	250		05-	•
NSS	250	Forza	05- 13	•
NSS	300	Forza	14-	•
SH	300	i	07-	•
SH	300	iSH30	15-	•

# Brake Pads

3083 ORGANIC  
4083 SINTERED

A 45,2 | L 41,2 | S 7,0

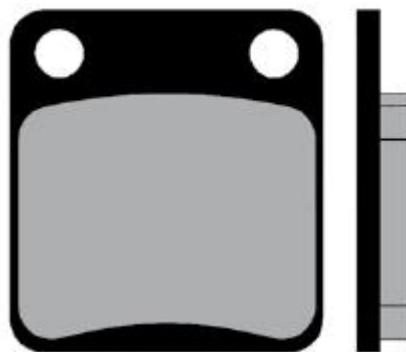







## DAELIM

	50	Delfino	99-	•	
	50	E-Five	03-	•	
	50	History, S-Five	01-	•	•
	50	Message II	02-	•	
	50	Tapo	99-	•	
	50	Vivo	99-	•	
SE	50	Cordi	06-	•	
	100	Altino	99-	•	
	100	Delfino	99-	•	
	125	Altino	02-	•	
	125	DLX, Otello DLX	01-	•	•
	125	History	01-	•	•
	125	Message II	00-	•	
	125	Otello	99-	•	
	125	Otello	08-		•
	125	S2	06-		•
	125	S2 FI	07-		•
NF	125		03-	•	
NS	125	II	00-	•	
VS	125	Evolution	95-	•	
SL	125	U3 FI	07-		•
	250	S2	06-		•

## HONDA

CB	50	all models	80- 81	•	
CRM	50		88- 92	•	

					
MB	50 S		80- 82	•	
MBX	50		80- 82	•	
MRX	50		88-	•	
SP	50		- 91	•	
MBX	80	FWD	83- 86	•	
CB	80		80- 81	•	
CB	125	RS	83-	•	
CG	125		04-	•	
CG	150		04-	•	
ATC	250	R	81	•	
<b>HUSQVARNA</b>					
		all models CRT, IC, IE, WR	92- 94		•
<b>HYOSUNG</b>					
TE	400		05- 06	•	
TE	450		07-	•	
<b>KAWASAKI</b>					
KX	65		00-		•
BN	125	Eliminator	98- 99	•	
KLX	125		10- 14		•
KLX	125	D-Tracker	10- 14		•
Z	125	Pro	17-		•
KLX	150	D-Tracker	16-		•
KLX	150	L	14-		•
KVF	300	Brute Force	13-	•	
KVF	360	Prairie 2x4, 4x4	03-	•	
KVF	400	Prairie	97- 98	•	
KVF	400	Prairie 2x4	99-	•	
KVF	400	Prairie 4x4	99-	•	
<b>MASH</b>					
	125	Cafe Racer	14-		•
	125	Seventy Five	14-		•
	250	Cafe Racer	14-		•
	250	Two Fifty	14-		•
<b>PGO</b>					
	50	Bugrider	06-		•
BR	150	Bugxter	05-		•
<b>PEUGEOT</b>					
	50	Vivacity	08-	•	
<b>SACHS</b>					
	50	MadAss4T	05-		•
	125	MadAss	09-		•
<b>SUZUKI</b>					
RM	65		03- 06		•
DR	125		86- 02	•	
GX	125	R	88-	•	
RH	125	X	87	•	
SP	125		86- 88	•	
SX	125		85-	•	
TS	125		85- 89	•	
DR	200		86- 88	•	
DR	200	S	15-	•	
DR	200	SE	96- 13	•	
DR	200	T	96	•	
SP	200		86- 88	•	
SX	200	R	85-	•	
RH	240	X	87-	•	
TS	240	X	85-	•	
DR	250		85- 89	•	
LTF	250	Ozark	03-	•	





LT-Z	250	Quad Sport	04-	•
RH	250		85-	•
SP	250		85	•
TS	250	X	85- 89	•
LT-A	400	Eiger 2WD/4WD	02- 07	•
LT-F	400	Eiger 2WD/4WD	02-	•
LT-A	500	F Vinson	02-	•

**YAMAHA**

SX	125	R	88-	•
SX	200	R	88-	•
YFS	200	R Blaster	03- 06	•
YFM	250	AN Bruin 2x4	05-	•
YFM	250	Bear Tracker	01-	•
YFM	300	Warrior	89	•
YFM	350	Bruin 2x4, 4x4	04-	•
YFM	350	FWBL, LC Big Bear	99	•
YFM	350	FXG-FXM Wolverine	95-	•
YFM	350	XG,XH Warrior	95- 96	•
YFM	350	XW,XA-MW Warrior	89-	•
YFZ	350	Banshee	90- 06	•
YFM	400	FAM Kodiak	00-	•
YFM	400	FAR Kodiak Automatic	03	•
YFM	400	FWN Big Bear 4WD	00-	•
YFM	400	FWNH Big Bear-Buckmaster 4WD	00-	•
YFM	400	N Big Bear 2WD	00-	•
YFM	450	FA_Kodiak	03-	•
YFM	450	Wolverine	06-	•

# Brake Pads

3084 ORGANIC  
4084 SINTERED

A 36,4 | L 93,9 | S 8,6  
A 36,4 | L 93,9 | S 10,1

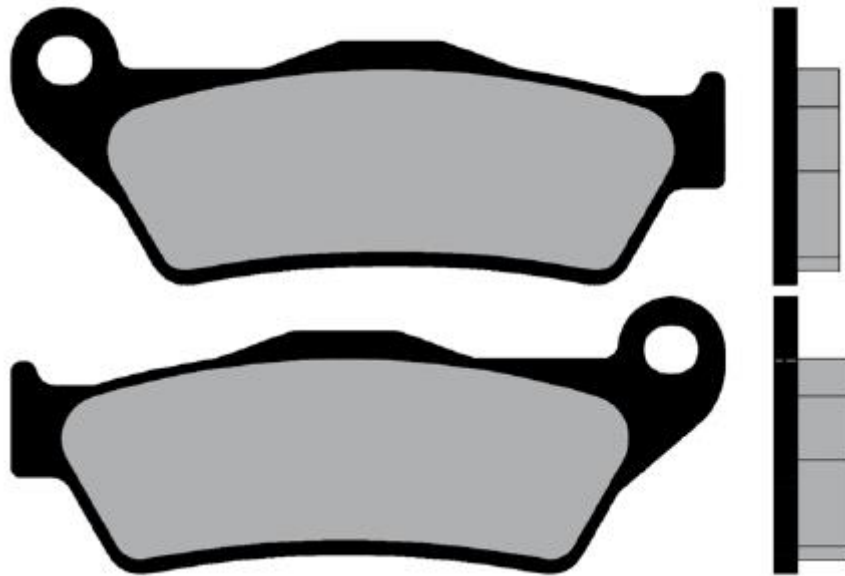

## BMW

R	850	C	99- 01	•
R	850	GS	99- 07	•
R	850	R	96-	•
R	850	R	03- 07	•
R	850	RT With Integral ABS	01- 06	•
S	1000	XR	15-	•
R	1100	GS	99	•
R	1100	R	99-	•
R	1100	RT	95-	•
R	1100	S	99- 00	•
R	1100	S With Integral ABS	01- 05	•
R	1100	S Without Integral ABS	01- 05	•
R	1100	GS	94-	•
R	1150	GS	00- 01	•
R	1150	GS,GS Adventurer	02- 05	•
R	1150	R	01- 06	•
R	1150	R Rockster	03- 05	•
R	1150	RS	01- 04	•
R	1150	RT With Integral ABS	01- 06	•
	1200	HP2 Megamoto	06- 08	•
K	1200	R	05- 08	•
K	1200	R Sport	05- 07	•
K	1200	S	05- 08	•
R	1200	C	98- 02	•
R	1200	C Classic	03- 04	•



R	1200	CIndependent	03- 04	•
R	1200	CMontauk	02- 04	•
R	1200	GS	04- 12	•
R	1200	GS Tripple Black	11-	•
R	1200	R	07- 14	•
R	1200	RI	06- 13	•
R	1200	S	06- 07	•
R	1200	SI	06- 07	•
K	1300	R	09-	•
K	1300	RDynamic	11-	•
K	1300	S	09-	

# Brake Pads

3085 ORGANIC  
4085 SINTERED

A 36,2 | L 71,1 | S 9,2

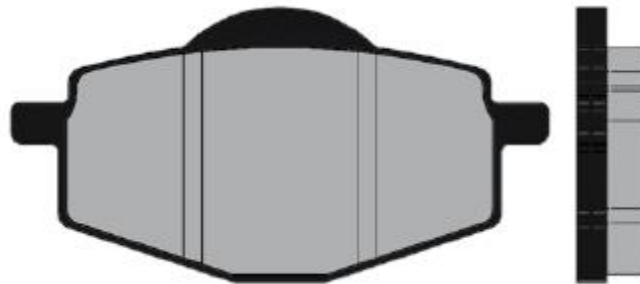

## GARELLI

		Xo Electric	12-	•
	125	Xo	12-	•
	150	Xo	12-	•
	200	Xo	12-	•

## GILERA

	125	Apache	91-	•
RC	125	Top Rally	90-	•
	250	Oregon Quad	07-	•
RC	600	Top Rally	90-	•

## MALAGUTI







	125	Centro ie	08- 11	•
	160	Centro ie	08- 11	•

## MBK

	125	Flame R/F	95- 03	•
	150	Vertex	97-	•

## YAMAHA

	50	Cygnus	96-	•
DT	50	R	89- 95	•
DT	50	R	96- 97	•
TDR	50		90-	•
TZM	50	R	94-	•
TZR	50		90- 92	•
YSR	50		87-	•
DT	80	LC-2	85- 92	•
RD	80	LC	83-	•
TDR	80		89	•
TZR	80		92-	•
YSR	80		86-	•
	105	Crypton	98-	•
DT	125	LC	85- 87	•

					
DT	125	R	96-07	•	•
DT	125	R, Electric	88-03	•	•
SR	125	Flame	96-	•	
XC	125	Cygnus F	00-	•	
XC	125	F	00-	•	
XC	125	TR Cygnus R	96-	•	
IDR	125	R	93-03		•
YBR	125		06-07	•	
YZ	125		88		•
XC	150	Fly One	92-	•	
XC	150	Fly One R	98-	•	
RT	180		95-96	•	
DT	200		85-87	•	
DT	200		89	•	•
IT	200		85-	•	
TT	200		86-	•	
	225	Serow	85-	•	
TT	225	S,T	86-00	•	
TTR	225		01-	•	
XT	225		92-00	•	
XT	225	Serow	86-	•	
IT	250		85-	•	
TY	250	Z (Scottish)	96-	•	
YZ	250	Tri Moto	85-86	•	•
YZ	250		88		•
XT	350		85-96	•	
YFM	350	XT, XU Warrior	87-88	•	
YFZ	350	Banshee	87-89	•	
	400	Artesia	91-		•
XT	400		86-	•	
WR	500	B	91		•
XT	500		86-	•	
XT	500	E (Austria)	90-96		•
DT	600	N	85-	•	
TT	600		85-88	•	
XT	600	E	90-		•
XT	600	K	91-		•
XT	600	Z, Tenere	87-90		•
XTZ	660	Tenere	91-98		•

# Brake Pads

3086 ORGANIC  
4086 SINTERED

A 40,7 | L 62,0 | S 9,0

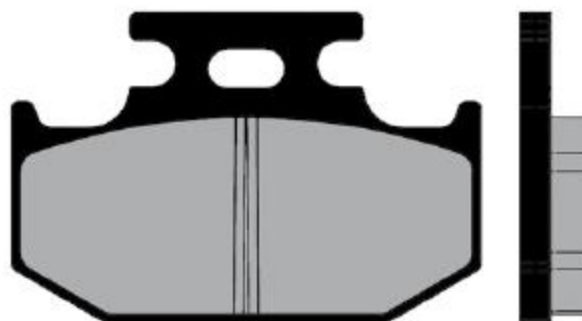

## CANNONDALE

MX	400		00- 03	•
C	440	R	03	•
E	440	A, R	03	•
S	440		03	•
X	440		03	•

## KAWASAKI

KDX	125		90- 94	•
KX	125		89- 94	•
KDX	200		93- 99	•
KDX	200	SR	89- 92	•
KDX	220	R	97-	•
KDX	250	SR	91- 94	•
KLX	250		93- 96	•
KX	250		89- 94	•
KX	500		89- 95	•
KLX	650		93- 96	•
KLX	650	R	93- 95	•

## SUZUKI

RM	125		89- 90	•
RM	125		91- 95	•
TS	125		89- 96	•
TS	200	R	90- 94	•
DR-Z	250		01-	•
	250	Djebel	93-	•
DR	250		90- 95	•
RM	250		89- 90	•
RM	250		91- 95	•
RMX	250		89- 98	•
DR	350		90- 99	•
DR	350	V,W,X	97-	•



DR	650	SET-W	96-	•
<b>YAMAHA</b>				
FZR	50		92-	•
YD	80		89-	•
DT	125	X Supermotard	05-	•
WR	125		91- 97	•
YZ	125		90- 95	•
YZ	125		96- 97	•
DT	200	WR	91- 93	•
WR	200		91- 92	•
TT	250		93- 03	•
TY	250	Z (Scottish)	96-	•
WR	250		90- 97	•
XG	250	Tricker	05-	•
XT	250		08-	•
YZ	250		90	•
YZ	250	WRA,WRB	90- 91	•
YZ	250	B1-J1	91- 97	•
TT	350		95-	•
WR	400	F	98	•
YZ	400		98	•
WR	500	ZD,ZE	92- 93	•
TT	600	R	93- 95	•

# Brake Pads





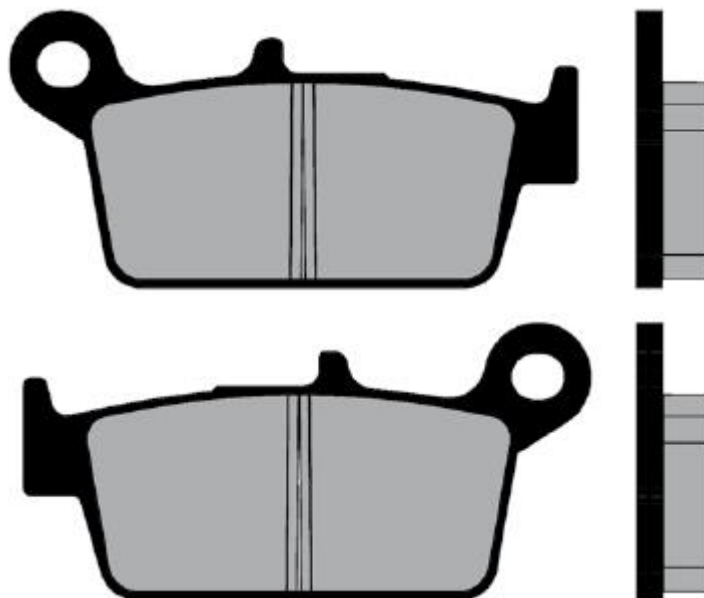

3087 ORGANIC  
4087 SINTERED  
6087 OFF ROAD

A 36,4 | L 75,0 | S 9,7



<b>AJP</b>				
PR5	250	Enduro	09	•
PR5	250	Supermotard	09	•
PR7	650	Adventure	17-	•
<b>BIMOTA</b>				
BBX	508	Enduro	12-	•
<b>BRAKING</b>				
Rear cross (2 piston)				
<b>CPI</b>				
	125	Sahel	02-	•
<b>DAELIM</b>				
	50	Besbi	07-	•
SC	125	Besbi	08- 13	•
<b>ENDRESS</b>				
EMR	50		95-	•
<b>FANTIC</b>				
	50	Regolama Competizione	08-	•
MX	50	Regolama Competizione	08-	•
MX	65	Regolama Competizione	08-	•
	80	Regolama Competizione	08-	•
MX	85	Regolama Competizione	08-	•
	125	Regolama Competizione	08-	•
<b>GAS GAS</b>				
FC	125		00-	•
MC	125		03-	•
SM	125		02-	•



					
EC	200		00-		•
EC	200	Hobby	07- 16		•
EC	250		00- 11		•
EC	250	fse	02-		•
MC	250		00-		•
SM	250		02-		•
EC	300		00- 11		•
	400	Pampera	06-		•
EC	400	fse	02		•
SM	400	fse	02		•
EC	450	fse	03-		•
EC	450	FSR	07- 16		•
SM	450	fse	03- 06		•
SM	450	FSR	07-		•
EC	515	fsr	08- 16		•
<b>HM</b>					
CRE	50		06- 13		•
	125	Supermotard	00- 02		•
CRE	125	Enduro	95- 01		•
CRE	125	Supermotard	03		•
	250	Supermotard	00- 02		•
CRE	250	Enduro	95- 01		•
CRE	250	Supermotard	03		•
<b>HONDA</b>					
CB	50	Replica	99-		•
CRM	50		88- 96		•
NH	50	Lead	94-	•	
SRX	50	Shadow	98-	•	
	75	Yupy	90-	•	
NS-1	75		92-		•
CRM	75	R	90- 94		•
CR	80	R, RB	92- 02		•
CRM	80		89-		•
NSR	80	R	87-		•
CR	85	R, RExpert	03-		•
NH	90	Yupy	90- 94	•	
SRX	90	Shadow	99-	•	
NSF	100		06-		•
CR	125	R	95- 01		•
CR	125	RH, RI, RK	87- 94		•
NS	150		92-	•	
CRF	230	L	08-		•
CRF	230	M	09-		•
SL	230		97- 01		•
CR	250	R	87- 01		•
XLR	250	RSPL	94-		•
XR	250	L	91- 97		•
XR	250	R	90- 95		•
XR	250	S, R	96-		•
XR	300		10-		•
XR	400	R	96-		•
XR	400	Supermotard	00-		•
XR	440	R	00-		•
CR	500	R	87- 01		•
XR	600	R	91- 00		•
XR	650	L	93- 12		•
XR	650	R	00- 11		•
<b>HYOSUNG</b>					
XRX	400		05-		•

**JINCHENG**

JC	125	2B	97-	•
----	-----	----	-----	---

**ITALJET**

	125	Amarcord	08-	•
--	-----	----------	-----	---

**KAWASAKI**

KX	125		95- 08	•
KLX	250		98- 07	•
KLX	250		14-	•
KLX	250	S	09-	•
KLX	250	SF	09-	•
KX	250		95- 08	•
KLX	300	R	97-	•
KLX	400	R	03-	•
KLX	400	SR	03-	•
KX	500		96-	•
KLX	650	RDI	96	•

**KYMCO**

	50	Cobra Cross	01-	•
	50	Cobra Exclusive	01-	•
	50	Cobra Racer	01-	•
	50	Easy	01-	•
	50	Filly LX	01	•
	50	Heroism	95- 96	•
	50	Scout	95-	•
	50	Topboy on/off road	96-	•
	50	Topboy Racer/Cross	01-	•
	50	Yup	01	•
CX	50	Curio Super	94-	•
DD	50	Sniper	94-	•
K12	50		95-	•
KB	50		95-	•
ZX	50	Fever	96-	•
	50	Cobra Cross	99- 00	•
	50	Cobra Racer	99- 00	•
	50	Super-9	00- 01	•
	50	ZX12	06-	•
ZX	50	Super Fever	02-	•
	90	Manboy	96-	•
	100	Topboy on/off road	99-	•
KB	100		99-	•
	125	Super-9	00-	•
	150	Freeway	95-	•
	250	Super-9	00-	•

**MOTOR UNION**

JC	125	2B Deer	98-	•
----	-----	---------	-----	---

**PEUGEOT**

SV	50	Geo	92	•
SV	50	Geo	93-	•
SV	50	L	93-	•
SV	80	Geo	91- 92	•
SV	80	Geo	93-	•
SV	125	C Executive	96-	•
SV	125	Executive	94-	•
SV	125	Geo	91- 92	•
SV	125	Geo	93-	•

**SHERCO**

SE	450	4.5i Enduro	04	•
----	-----	-------------	----	---

**SUZUKI**

DR	125	SM	08-	•
----	-----	----	-----	---



RM	125		96-09	•
RM	250		96-09	•
RMX	250	X-K1	99-	•
DR-Z	400	S/E	00-	•
DR-Z	400	SM	05-10	•
<b>TM</b>				
	85		01-12	•
	125		01-04	•
	125	Enduro	01-04	•
SMR	125		05-	•
	250		01-04	•
	250	Enduro	01-04	•
	250	F	01-04	•
	250	F Enduro	01-04	•
	300		01-04	•
	300	Enduro	01-04	•
	400	F	01	•
	400	F Enduro	01	•
SMF	400	F	02	•
SMR	400	F	03	•
	450	F	02-04	•
	450	F Enduro	02-04	•
SMR	450	F	04-	•
SMX	450	F	03-	•
	530	F	01-04	•
	530	F Enduro	01-04	•
SMR	530	F	03-	•
SMX	600	F	03	•
SMX	660	F	04-	•
<b>YAMAHA</b>				
WR	125		98-02	•
YZ	125		98-02	•
WR	250		98-02	•
WR	250	F	01-02	•
YZ	250		98-02	•
YZ	250	F	01-02	•
WR	400	F	99-00	•
YZ	400	F	99	•
WR	426	F	01-02	•
YZ	426	F	00-02	•

# Brake Pads

3088 ORGANIC

4088 SINTERED

6088 OFF ROAD

A 41,3 | L 78,0 | S 9,0

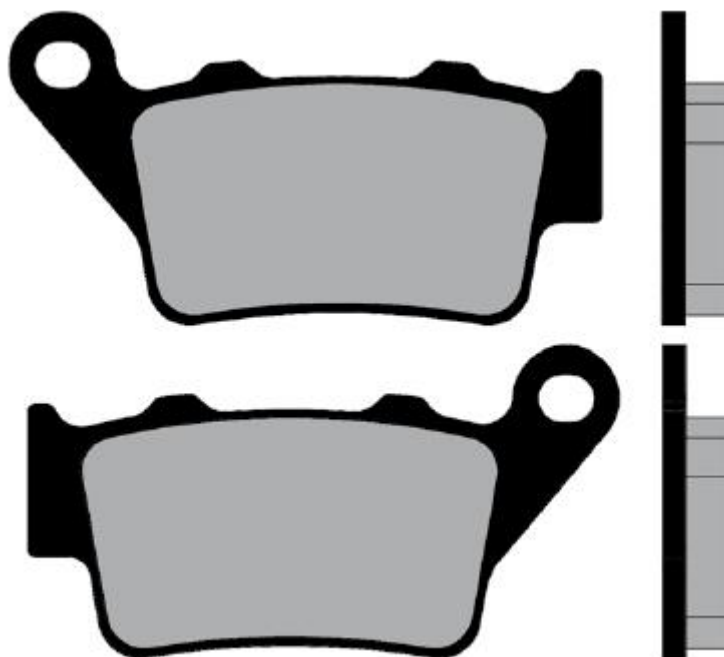

## ALFER







VRE	125	4-stroke	00-	•
VR	250	Cross	99-	•
VR	250	Enduro	99-	•
VR	250	No Limit	99-	•
VR	250	Supermotard	99-	•







## APRILIA

	650	Pegaso Factory	07- 09	•
	650	Pegaso i.e.	01- 04	•
	650	Pegaso i.e. Tuscany Tibet Raid	04-	•
	650	Pegaso Strada	05- 09	•
	650	Pegaso Trail	06- 08	•
	750	Dorsoduro Factory	12-	•
SL	750	ShiverGT, ABS	09-	•
SL	750	Shiver, ABS	07-	•
SMV	750	Dorsoduro	08- 16	•
NA	850	Mana	07	•
	900	Dorsoduro	17-	•
	900	Shiver	17-	•
	1200	Caponord	13-	•
	1200	Caponord Rally	15-	•
	1200	Dorsoduro, ABS	11-	•

## BENELLI







BX	449	Cross	07-	•
BX	449	Supermotard	08-	•

					
BX	505	Enduro	08-		•
<b>BETA</b>					
	125	Jonathan	99-		•
	350	Euro	99-		•
	350	Jonathan	02-		•
<b>BMW</b>					
	125	C1	00-		•
	200	C1	02-		•
G	310	GS	17-		•
G	310	R	16-		•
F	650	ST	94- 00		•
F	650	CS Scarver	02- 06		•
F	650	GS	08- 12		•
F	650	GS ABS	01- 07		•
F	650	GS ABS	08- 12		•
F	650	GS Dakar	01- 07		•
F	650	GS Rallye	01- 07		•
F	650	ST Strada	97- 01		•
G	650	GS	09-		•
G	650	GS Sertao	12- 14		•
G	650	Xchallenge	06- 07		•
G	650	Xcountry	06- 09		•
G	650	Xmoto	06- 07		•
F	700	GS	13-		•
F	800	GS	08-		•
F	800	GT	13-		•
F	800	R	09-		•
F	800	S	06- 10		•
F	800	ST	06- 12		•
F	800	ST Touring	11- 12		•
R	850	RT	96- 01		•
S	1000	R	13-		•
S	1000	RR	09-		•
S	1000	RRHP4	12- 14		•
<b>BORILE</b>					
B	500	CRMT	02-		•
<b>BREMBO RACING CALIPERS</b>					
Motocross Caliper 22.2180.20					
<b>CCM</b>					
GP	450		16-		•
604	600	RS	01		•
604E	600	Sport	99- 01		•
604E	600	Supermoto	99- 01		•
C25	600		96- 98		•
	644	D6	02- 06		•
	644	R30	02- 06		•
<b>CF MOTO</b>					
	400	NK Bfi	17-		•
	650	NK	14- 16		•
	650	NK Bfi	17-		•
	650	TK	14-		•
<b>DUCATI</b>					
	400	Scrambler Sixty Two	16-		•
	797	Monster	17-		•
	800	Scrambler Classic	15-		•
	800	Scrambler Enduro	15-		•
	800	Scrambler Flat Track Pro	16-		•
	800	Scrambler Full Throttle	15-		•
	800	Scrambler Icon	15-		•







					
800		Scrambler Urban Enduro	16-		•
800		Scrambler-X Desert Sled	17-		•
1000		Biposto	07-		•
1000		GT	05- 10		•
1000		GT Touring	09-		•
1000		Paul Smart	05-		•
1000		1000 Sport, Sport S	05- 09		•
<b>FACTORY</b>					
YR	250		99-		•
<b>FANTIC</b>					
	500	Caballero	17-		•
<b>GAS GAS</b>					
EC	125		97- 99		•
EC	200		99		•
EC	250		97- 99		•
MC	250		97- 99		•
EC	300		99		•
<b>HIGHLAND</b>					
	450	MX	06-		•
	950	V2 Motard	00-		•
	950	V2 Outback	99-		•
<b>HONDA</b>					
CBR	250	R (Bybre cal)	11-		•
CB	500		97-		•
CB	500	S	98- 03		•
NX	500	Dominator (Austria)	97-		•
FX	650	Vigor	99- 02		•
NX	650	Dominator	97- 99		•
SLR	650		97- 99		•
<b>HRD</b>					
	50	GS Enduro	00- 02		•
<b>HUSABERG</b>					
FC	400		99- 02		•
FE	400	S,E	99- 03		•
FS	400	e, c	01- 03		•
FC	450		03- 08		•
FE	450	e	04- 08		•
FS	450	c	06- 08		•
FS	450	e, c	03- 05		•
FX	450	e	03- 08		•
FC	470	e	01- 02		•
FX	470	e	01- 02		•
FC	501		99- 01		•
FE	501	S,E	99- 04		•
FC	550		01- 05		•
FE	550	e	04- 08		•
FC	600		99- 01		•
FE	600	S,E	99- 02		•
FE	650	e	01- 08		•
FS	650	e, c	01- 08		•
FX	650	e	01- 05		•
<b>HUSQVARNA</b>					
CR	125		96- 04		•
SM	125	S	09- 13		•
SM	125	S4T	11- 13		•
SM	125	Supermotard, S	99- 13		•
TE	125	4T	11- 13		•
WR	125		96- 13		•
WRE	125		96- 13		•



CR	250		96- 04	•
TC	250		02- 03	•
TE	250		02- 13	•
WR	250		96- 13	•
TE	350		96- 13	•
WR	360		98- 13	•
SM	400	R	02	•
TE	400		01- 13	•
	401	Svartpilen	17-	•
	401	Vitpilen	17-	•
TE	410		96- 13	•
SM	450	R	03- 04	•
SM	450	R	05	•
TC	450		02- 03	•
TE	450		02- 10	•
SM	510	R	05	•
TC	510		02- 03	•
TE	510		02- 10	•
TE	510	Centennial	04- 05	•
	570	Nox	01- 03	•
SM	570	R	01-	•
TC	570		01- 13	•
TE	570		01- 13	•
LT	610		00-	•
SM	610	Super Motard, S	98-	•
TC	610		96- 13	•
TE	610	Rallye	96- 13	•
SMR	630		04- 08	•
TR	650	Strada	13-	•
TR	650	Terra	13-	•
FE	701	Enduro	17-	•
SM	701	Supermoto	15-	•
	900	Nuda	12-	•
	900	Nuda R, ABS	12-	•
<b>HYOSUNG</b>				
RX	450	SM	08-	•
<b>INDIAN</b>				
	1000	Scout Sixty	17-	•
	1200	Scout	17-	•
<b>KRAM-IT</b>				
	250	SMR	00-	•
GS	250		97-	•
MX	250		97-	•
SM	250		97-	•
<b>KTM</b>				
		most models	94-	•
	125	Duke	11-	•
	125	Sting	99-	•
	125	SuperMoto	00-	•
EXC	125	Enduro	99- 03	•
EXE	125		00-	•
LC2	125		99-	•
RC	125		14-	•
SX	125		96- 03	•
	200	Duke	12-	•
EXC	200	Enduro	99- 03	•
RC	200		14-	•
EXC	250	Enduro	99- 03	•
EXC	250	Enduro 4T	99- 03	•

					
SX	250		96-02		•
EXC	300	Enduro	99-03		•
MX	360		96-97		•
SX	360		96-97		•
XC	360		96-97		•
EXC	380	Enduro	99		•
MX	380		98-		•
SX	380		98-02		•
XC	380		98-		•
	390	Duke	13-		•
RC	390		14-		•
EXC	400	Racing	00-03		•
LC4E	400	Enduro	99-02		•
SC	400		99-		•
SX	400	Racing	00-02		•
SXC	400	Tiainen Replica	99-00		•
	450	Rally	11-		•
EXC	520	Racing	00-02		•
SX-F	520	Racing	00-02		•
EXC	525	Racing	03		•
SX-F	525	Racing	03		•
SXC	540	Tiainen Replica	99-00		•
LC4	620	Competition	99-		•
LC4	620	Competition SuperMoto	00-		•
LC4	620	RXC	95		•
LC4	620	Supercompetition	01-		•
SC	620		99-		•
SX	620		95-99		•
LC4	625	SC Supermoto	02-04		•
SMC	625		05-		•
SXC	625		03-04		•
	640	Duke	03-06		•
LC4	640	Adventure	99-07		•
LC4	640	Supermoto	03-		•
LC4E	640	Enduro	99-		•
LC4E	640	Supermoto	99-02		•
LC4	660	Rallye	01-03		•
LC4	660	SM Factory Replica	02-		•
SMC	660	Supermoto	03-07		•
	690	Duke	08-11		•
	690	Duke ABS	12-		•
	690	Duke R	10-11		•
	690	Duke R	14-		•
	690	Enduro	08-		•
	690	Enduro R	09-		•
	690	SM	07-		•
	690	SMC	08-		•
	690	Supermoto R	08-		•
LC8	950	Adventure	02-07		•
	990	Super Duke	04-13		•
	990	Super Duke R	04-14		•
<b>MAICO</b>					
	250	Motocross	99-		•
	500	Motocross	99-		•
	500	Supermotard	99-		•
<b>PRAGA</b>					
ED	250		99-		•
CD	610		99-		•
<b>ROYAL ENFIELD</b>					



					
	535	Continental GT	14-		•
<b>SWM</b>					
	650	Superdual	15-		•
<b>TM</b>					
	80	Cross	96- 00		•
	125		96- 00		•
	250	E	95- 00		•
	250	F Enduro	00		•
	300		98- 00		•
	320		96- 97		•
	400	F	00		•
<b>TRIUMPH</b>					
	675	Daytona R Triple (Rad.cal)	13-		•
	675	Daytona Triple (Rad.cal)	13-		•
	675	Street Triple	13-		•
	675	Street Triple R	13-		•
	675	Street Triple RX	15-		•
<b>VERTEMATI</b>					
C	500	Cross	02- 04		•
E	501	Enduro	02- 04		•
S	501	Supemotard	02- 04		•
<b>VICTORY</b>					
	1200	Octane	17-		•
<b>VOR</b>					
	400	Cross	00- 01		•
	400	Enduro	00- 01		•
EN	400		02-		•
MX	400		02		•
SM	400		02		•
EN	450		02-		•
MX	450		02-		•
SM	450		02-		•
	500	492 Enduro	99		•
	500	492 Super Motard	00- 01		•
	500	495 Cross	99		•
EN	530		02-		•
MX	530		02-		•
SM	530		02-		•
<b>YAMAHA</b>					
WR	125	R,XY	09-		•
TT	600	E,S	96- 01		•
TT	600	R	98- 07		•
MT-03	660		06- 13		•
XT	660	R	04- 11		•
XT	660	X	04- 13		•
XT	660	Z Tenere	08- 14		•
XT	660	Z Tenere ABS	11- 14		•
<b>ZERO</b>					
DS	ZF11.4		14		•
DS	ZF12.5		15		•
DS	ZF13.0		16-		•
DS	ZF8.5		14		•
DS	ZF9.4		15		•
DS	ZF9.8		16-		•
DSR	ZF13.0		16-		•
FX	ZF2.8		14-		•
FX	ZF3.3		16-		•
FX	ZF5.7		14-		•
FX	ZF6.5		16-		•



FXS	ZF3.3	16-	•
FXS	ZF6.5	16-	•
S	ZF11.4	14	•
S	ZF12.5	15	•
S	ZF13.0	16-	•
S	ZF8.5	14	•
S	ZF9.4	15	•
S	ZF9.8	16-	•
SR	ZF11.4	14	•
SR	ZF12.5	15	•
SR	ZF13.0	16-	•

# Brake Pads





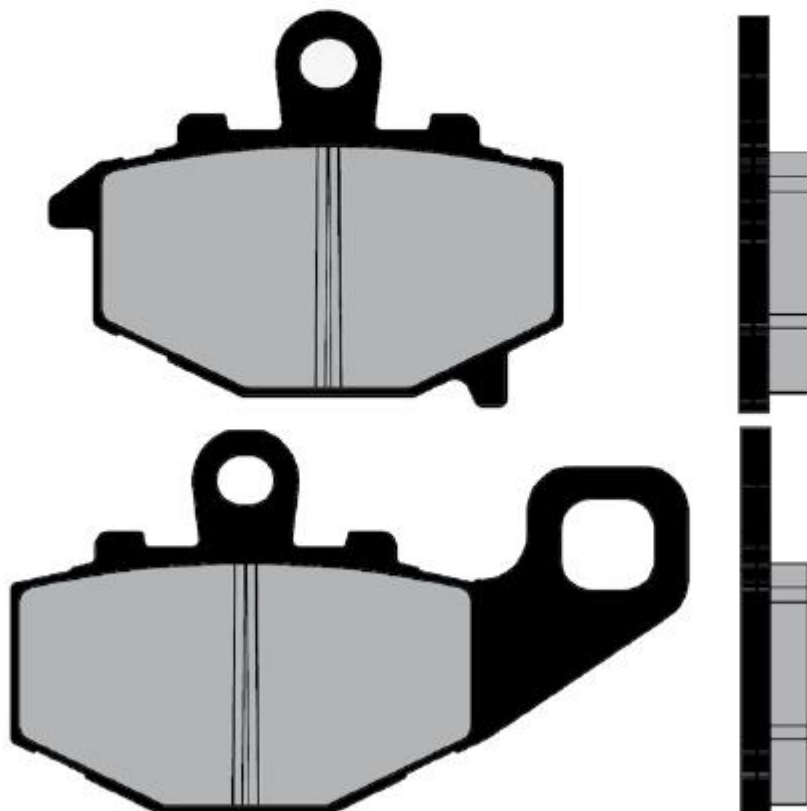

3089 ORGANIC  
4089 SINTERED

A 51,1 | L 68,0 | S 9,9  
A 51,1 | L 89,5 | S 8,9



## KAWASAKI

	400	Ninja R Left/Rear	11-	•
ZZR	500	Austria	93-	•
ZR	550	Zephyr	93- 99	•
ZR	550	Zephyr (D) from VIN B024010-	93- 01	•
ZX-6R	600	(Ninja ZX6)	93- 97	•
ZX-6R	600	(Ninja ZX6R)	95- 97	•
ZX-6R	600	Ninja	98- 01	•
ZX-6R	600	Ninja (Rad.cal)	07-	•
ZX-6RR	600	Ninja (Rad.cal)	03- 06	•
ZZR	600	600	93- 05	•
ZX-6R	636	Ninja	02	•
ZX-6R	636	Ninja (Rad.cal)	03- 06	•
ER-6f	650	Left/Rear	06-	•
ER-6n	650	Left/Rear	06- 16	•
KLE	650	Versys Left/Rear	07- 14	•
Z	750	Left/Rear	04- 06	•
Z	750	S Left/Rear	05- 06	•
ZX-9R	900	Ninja	94- 03	•
Z	1000	(Rad.cal)	14-	•
Z	1000	(Rad.cal) ABS	15- 16	•
Z	1000		03- 06	•
Z	1000	R	17-	•

					
Z	1000	SE (Rad.cal)	14-		•
Z	1000	SX (Rad.cal)	11- 16		•
Z	1000	SX (Rad.cal)	17-		•
ZX-10R	1000	Ninja (Rad.cal)	04- 10		•
GPZ	1100	(ZX 1100) Left/Rear	95- 99		•
GPZ	1100	ABS, Horizont Left/Rear	97-		•

# Brake Pads

3090 ORGANIC

4090 SINTERED

5090 CERAMIC

A 40,1 | L 108,5 | S 7,7

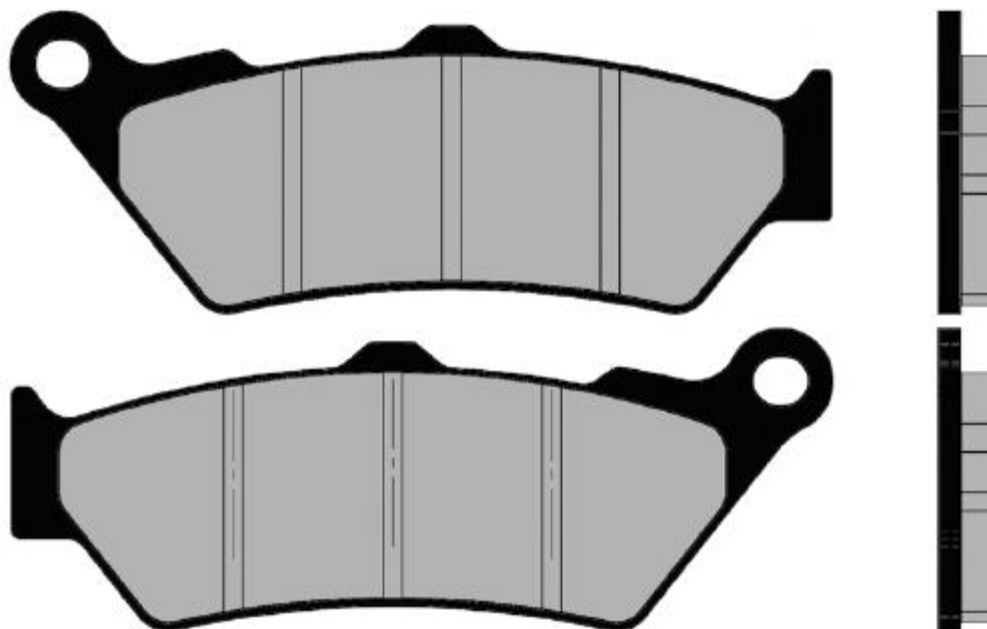

## APRILIA







	650	Moto	95-	•
	650	Pegaso	95- 00	•
	650	Pegaso i.e.	01- 04	•
	650	Pegaso i.e. Tuscany Tibet Raid	04-	•
	650	Pegaso Trail	06- 08	•
	650	Starck	96-	•
EIV	1000	Caponord	01- 08	•
EIV	1000	Caponord Rally Raid	04- 08	•

## BIMOTA

	DBX	1100	13-	•
--	-----	------	-----	---

## BMW

		125	C1	00-	•
		200	C1	02-	•
F		650	ST	94- 00	•
F		650	CS Scarver	02- 06	•
F		650	CS	08- 12	•
F		650	CSABS	01- 07	•
F		650	CSABS	08- 12	•
F		650	CS Dakar	01- 07	•
F		650	CS Rallye	01- 07	•
F		650	ST Strada	97- 01	•
G		650	CS	09-	•
G		650	CS Sertao	12- 14	•
G		650	Xchallenge	06- 07	•
G		650	Xcountry	06- 09	•

					
F	700	GS	13-	•	
F	800	GS	08-	•	
	1200	HP2Enduro	04- 06	•	
R	1200	GS	13-		•
R	1200	GSAdventure	14-		•
R	1200	R	15-		•
R	1200	RS	15-		•
R	1200	RT	14-		•
K	1600	B	17-		•
K	1600	GT	11-		•
K	1600	GTL	11-		•
<b>CF MOTO</b>					
	400	NK Efi	17-	•	
	650	NK	14- 16	•	
	650	NK Efi	17-	•	
	650	TK	14-	•	
<b>DUCATI</b>					
	400	Scrambler Sixty Two	16-	•	
	1000	Biposto	07-	•	
	1000	GT	05- 10	•	
	1000	GT Touring	09-	•	
	1000	Paul Smart	05-	•	
	1000	Sport, Sport S	05- 09	•	
	1200	Diavel	11-		•
	1200	Diavel Strada	11-		•
	1200	Multistrada Enduro	16-		•
	1200l	Xdiavel	16-		•
	1200	Xdiavel S	16-		•
<b>HARLEY DAVIDSON</b>					
XG	500	Street	16-	•	
XG	750	Street	16-	•	
<b>HONDA</b>					
CBR	250	R (Bybre cal)	11-	•	
CB	500		97-	•	
CB	500	S	98- 03	•	
FX	650	Vigor	99- 02	•	
NT	650	V Deauville	98-	•	
NX	650	Dominator	97- 99	•	
SLR	650		97- 99	•	
<b>HUSQVARNA</b>					
TR	650	Strada	13-	•	
TR	650	Terra	13-	•	
FE	701	Enduro	17-	•	
<b>INDIAN</b>					
	1000	Scout Sixty	17-	•	
	1200	Scout	17-	•	
<b>KTM</b>					
	450	Rally	11-	•	
LC4	640	Adventure	05- 07	•	
	690	Enduro	08-	•	
	690	Enduro R	09-	•	
	950	R Superenduro	06- 08	•	
LC8	950	Adventure	02- 07	•	
	990	Adventure R	10-	•	
	990	Adventure, Adventure S, ABS	06- 11	•	
<b>MALAGUTI</b>					
	125	Madison 3	08-	•	
	250	Madison 3 ie	08-	•	
<b>MOTO-GUZZI</b>					



	940	Custom	07-	•
	1100	California EV	06-	•
	1100	California EV Touring	06-	•
IS	1100	California Jackal	00	•
IS	1100	California Jackal	01-	•
IS	1100	California Jackal Basic	00	•
	1100	California Jackal Basic	01-	•
	1100	California Special	99- 00	•
	1100	California Special	01-	•
	1100	California Special Sport Alloy	02-	•
	1100	California Stone Metal	02-	•
	1100	California Stone, Stone Touring	02-	•
	1100	California Titanium	03-	•
	1100	California Vintage	06-	•
	1100	Griso	05-	•
ES	1100	Quota	99-	•
	1400	Audace	16-	•
	1400	California Custom	13-	•
	1400	California Touring	13-	•
	1400	California Touring SE	16-	•
	1400	Eldorado	16-	•
<b>MOTO-MORINI</b>				
	1200	Granpasso	08-	•
	1200	GT	10-	•
	1200	Scrambler	09-	•
<b>ROYAL ENFIELD</b>				
	535	Continental GT	14-	•
<b>TRIUMPH</b>				
	1600	Thunderbird	09-	•
	1700	Thunderbird Commander	14-	•
	1700	Thunderbird LT	14-	•
	1700	Thunderbird Storm	11-	•
	2300	Rocket III	04-	•
	2300	Rocket III Classic	07-	•
	2300	Rocket III Roadster	10-	•
	2300	Rocket III Touring	13-	•
	2300	Rocket X	15-	•
<b>VICTORY</b>				
	1200	Octane	17-	•
	1500	Kingpin	04- 05	•
	1500	Touring Cruiser	03- 06	•
	1500	V92C Cruiser	98- 02	•
	1500	V92C Deluxe	01- 02	•
	1500	V92SC Sport Cruiser	00- 02	•
	1500	Vegas	03- 05	•
	1500	Vegas 8-Ball	05	•
	1634	Hammer	05- 07	•
	1634	Hammer S	06- 08	•
	1634	Kingpin	06- 07	•
	1634	Kingpin Tour	06- 07	•
	1634	Vegas	06- 07	•
	1634	Vegas 8-Ball	06- 07	•
	1634	Vegas Jackpot	06- 07	•
<b>YAMAHA</b>				
DT	125	X Supermotard	05-	•
XT	660	R	04- 11	•
<b>ZERO</b>				
DS		ZF12.5	15	•
DS		ZF13.0	16-	•



DS	ZF9.4	15	•
DS	ZF9.8	16-	•
DSR	ZF13.0	16-	•
FX	ZF3.3	16-	•
FX	ZF6.5	16-	•
FXS	ZF3.3	16-	•
FXS	ZF6.5	16-	•
S	ZF12.5	15	•
S	ZF13.0	16-	•
S	ZF9.4	15	•
S	ZF9.8	16-	•
SR	ZF12.5	15	•
SR	ZF13.0	16-	•



# Brake Pads

3091 ORGANIC

4091 SINTERED

5091 CERAMIC

A 44,5 | L 109,2 | S 8,3

A 37,4 | L 133,5 | S 8,3

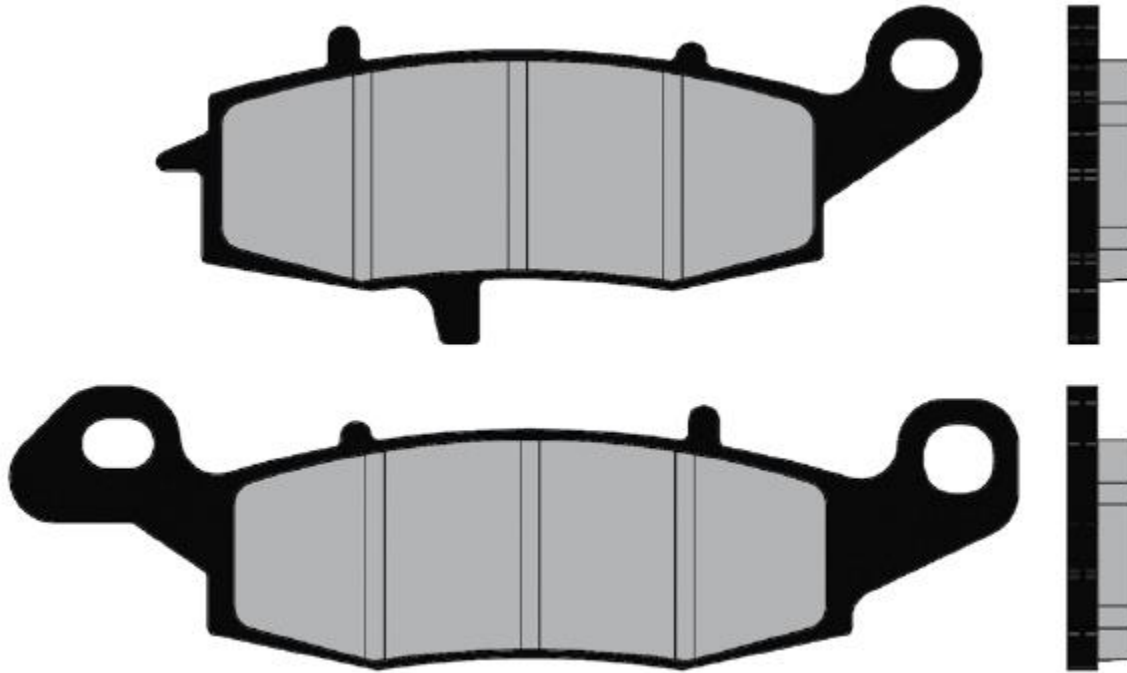

## KAWASAKI

	400	Ninja R Right	11-	•
ER-6f	650	Right	06-	•
ER-6n	650	Right	06- 16	•
KLE	650	Versys Right	07- 14	•
W	650		99-	•
Z	750	Right	04- 06	•
Z	750	S Right	05- 06	•
ZR	750	Zephyr Right	96-	•
ZR-7	750	Left/Rear	99-	•
ZR-7	750	Right	99-	•
ZR-7S	750	Left/Rear	01-	•
ZR-7S	750	Right	01-	•
VN	800	Drifter	99- 02	•
W	800		11-	•
KLV	1000	Right	04- 07	•
	1100	Zephyr Right	97-	•
GPZ	1100	(ZX 1100) Right	95- 99	•
GPZ	1100	ABS, Horizont Right	97-	•
VN	1500	Classic Tourer Fi Right	00-	•
VN	1500	Classic Tourer Right	98-	•
VN	1500	Drifter	99- 02	•
VN	1600	Classic Right	03-	•
VN	1700	Classic Right	09-	•
VN	1700	Classic Tourer Right	09-	•
RV	125	VanVan	03-	•



RV	200	VanVan	16-	•
GS	500		96-	•
GS	500	F	04-	•
GSF	600	Bandit / S Bandit Right	00- 04	•
GSX	600	FW Right	98-	•
DL	650	V-Strom Right	04- 13	•
DL	650	V-Strom Right	17-	•
DL	650	V-Strom XT Right	15- 16	•
DL	650	V-Strom XT Right	17-	•
GSF	650	Bandit / S Bandit Right	05	•
GSF	650	Bandit / S Bandit Right ABS	06	•
SFV	650	Gladius Right	09-	•
SV	650	S Right	99- 12	•
SV	650	Right	16-	•
XF	650	Freewind	97- 02	•
GSR	750	Right	11-	•
GSX	750	FW Right	98- 02	•
GSX	750	Right	98- 08	•
GSX-S	750	Right	15- 16	•
GSX-S	750	Z Right	15- 16	•
<b>SUZUKI</b>				
C	800	Intruder	05-	•
M	800	Intruder	05-	•
VL	800	Intruder LC Volusia	01- 04	•
VZ	800	Marauder	97- 04	•
DL	1000	V-Strom Right	02- 13	•
GSX	1100	G Right	96-	•
C	1500	Intruder Right	05- 10	•
M	1500	Intruder Right	09-	•
VL	1500	Intruder LC Right	02	•
C	1800	R Intruder	08-	•
M	1800	R Intruder	06-	•
M	1800	R2 Intruder	08-	•
M	1800	RBZ Intruder	16-	•

# Brake Pads

3092 ORGANIC

4092 SINTERED

5092 CERAMIC

A 44,5 | L 109,2 | S 8,3

A 37,4 | L 133,5 | S 8,3

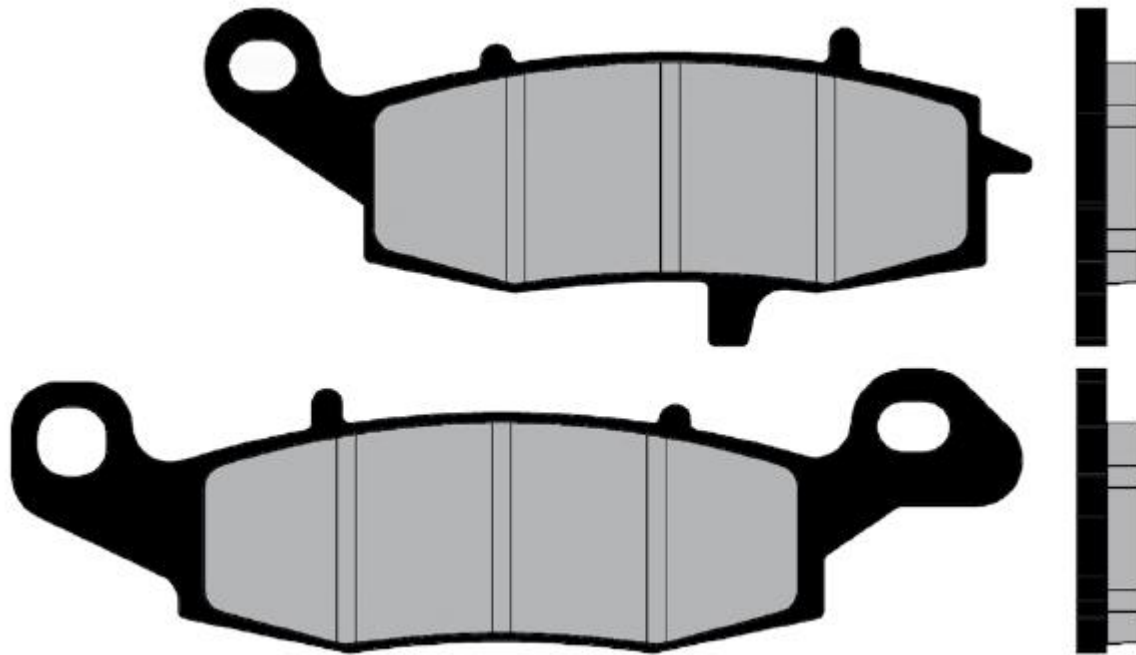

## KAWASAKI

	400	Ninja R Left/Rear	11-	•
ER-5	500		01-	•
ER-6f	650	Left/Rear	06-	•
ER-6n	650	Left/Rear	06- 16	•
KLE	650	Versys Left/Rear	07- 14	•
KLR	650	650	95- 04	•
Z	750	Left/Rear	04- 06	•
Z	750	S Left/Rear	05- 06	•
ZR	750	Zephyr Left/Rear	96-	•
ZR-7	750	Left/Rear	99-	•
ZR-7S	750	Left/Rear	01-	•
VN	800	Classic	98-	•
VN	800	Drifter	99- 02	•
VN	900	Classic	06-	•
VN	900	Classic SE	11-	•
VN	900	Custom	07-	•
KLV	1000	Left/Rear	04- 07	•
	1100	Zephyr Left/Rear	97-	•
GPZ	1100	(ZX 1100) Left/Rear	95- 99	•
GPZ	1100	ABS, Horizont Left/Rear	97-	•
VN	1500	Classic	97-	•
VN	1500	Classic Fi	00-	•
VN	1500	Classic Tourer Fi Left/Rear	00-	•
VN	1500	Classic Tourer Left/Rear	98-	•
VN	1500	Drifter	99- 02	•



VN	1600	Classic Left/Rear	03-	•
VN	1700	Classic Left/Rear	09-	•
VN	1700	Classic Tourer Left/Rear	09-	•

**SUZUKI**

GSF	250	VS, S Bandit	95-	•
TU	250	X	09-	•
GSF	600	Bandit / S Bandit Left/Rear	00- 04	•
GSX	600	FW Left	98-	•
DL	650	V-Strom Left/Rear	04- 13	•
DL	650	V-Strom Left/Rear	17-	•
DL	650	V-Strom XT Left/Rear	15- 16	•
DL	650	V-Strom XT Left/Rear	17-	•
GSF	650	Bandit / S Bandit Left/Rear	05	•
GSF	650	Bandit / S Bandit Left/Rear ABS	06	•
SFV	650	Gladius Left/Rear	09-	•
SV	650	S Left/Rear	99- 12	•
SV	650	Left/Rear	16-	•
GSR	750	Left/Rear	11-	•
GSX	750	FW Left/Rear	98- 02	•
GSX	750	Left/Rear	98- 08	•
GSX-S	750	Left/Rear	15- 16	•
GSX-S	750	Z Left/Rear	15- 16	•
DR	800	ST Big	96-	•
DL	1000	V-Strom Left/Rear	02- 13	•
GSX	1100	G Left/Rear	96-	•
C	1500	Intruder Left/Rear	05- 10	•
M	1500	Intruder Left/Rear	09-	•
VL	1500	Intruder LC Left/Rear	02	•

# Brake Pads

3093 ORGANIC

4093 SINTERED

5093 CERAMIC

A 55,5 | L 74,9 | S 8,5

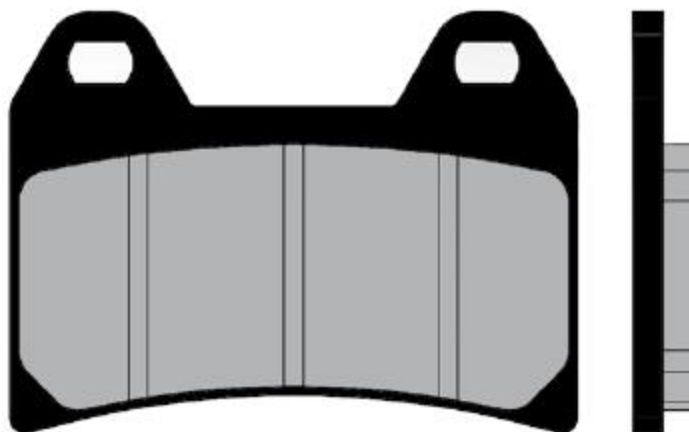







## APRILIA







RS	250		97- 02	•
RS	250	Pista	04-	•
	650	Pegaso Strada	05- 09	•
	750	Dorsoduro Factory	12-	•
SMV	750	Dorsoduro	08	•
	1000	Blue Marlin	02	•
RST	1000	Futura	01- 03	•
RSV	1000	Falco SL, R	00- 04	•
RSV	1000	Mille	97- 01	•
RSV	1000	Mille R	00	•
RSV	1000	Mille SP	00	•
RSV	1000	Tuono Fighter	03- 05	•
RSV	1000	Tuono R (Rad.cal), ABS	04-	•
RSV	1000	Tuono V4R	11- 13	•
	1200	Dorsoduro, ABS	11-	•

## BENELLI

666	125	Born in Hell	98-	•
BN	302		14	•
	500	Leoncino	16-	•
TRK	502		16-	•
BN	600		12- 13	•
	756	Cue	10-	•
	899	Trek	07-	•
TnT	899		07-	•
	900	Tomado 3	00- 06	•
TnT	1100		04	•
TnT	1130		05-	•
TnT	1130	Trek	06-	•
TnT	1130	Trek Amazonas	07-	•

## BIMOTA

					
DB4	900		99-00	•	
SB8	1000		98-00	•	
SB8K	1000		06-	•	
<b>BMW</b>					
G	650	Xmoto	06-07	•	
F	800	GT	13-	•	
F	800	R	09-14	•	
F	800	S	06-10	•	
F	800	ST	06-12	•	
F	800	ST Touring	11-12	•	
R	1200	Nine-T Pure	17-	•	
R	1200	Nine-T Racer	17-	•	
R	1200	Nine-T Scrambler	16-	•	
R	1200	Nine-T UrbanGS	17-	•	
<b>BRAKING</b>					
		Street, Supermotard			
<b>BRAMMO</b>					
		Empulse	14-16	•	
<b>BREMO RACING CALIPERS</b>					
		100 mm Motard Radial XA78910, P4 30/34			
		100 mm Radial 220A16810, P4 30/34			
		100 mm Radial 220A80310, P4 30/34			
		108 mm Motard Radial XA69510, P4 30/34			
		108 mm Radial 220A01610, P4 30/34			
		108 mm Radial 220A80210, Goldline two pin 20.6800, road Radial 220A16820, P4 30/34			
<b>CAGIVA</b>					
	650	Raptor	01-	•	
	650	V-Raptor	01-	•	
	1000	Raptor	00-	•	
	1000	V-Raptor	00-	•	
	1000	Xtra Raptor	02-	•	
<b>DUCATI</b>					
	400	Monster (Japan)	01-06	•	
	600	Monster	00-01	•	
	620	Monster Dark i.e.	02-06	•	
	620	Monster i.e., s i.e.	02-06	•	
	620	Multistrada Dark	05-06	•	
	620	Sport	03-06	•	
	696	Monster (Rad.cal)	08-12	•	
	748	S	99-02	•	
	748	R	00	•	
	748	SPS	98-99	•	
	750	Monster	00-01	•	
	750	Monster i.e.	02	•	
	750	Sport	00-02	•	
	750	Super Sport	00-02	•	
	795	Monster	12-	•	
	796	Hypermotard ABS	10-12	•	
	796	Monster (Rad.cal)	11-14	•	
	796	Monster ABS (Rad.cal)	11-14	•	
	800	Monster Dark i.e., s i.e.	03-07	•	
	800	Monster i.e., s i.e.	03-07	•	
	800	Sport	03-06	•	
	800	Supersport	03-06	•	
	848	(Rad.cal)	08-10	•	
	848	Streetfighter	12-	•	
	900	Monster	00-01	•	
	900	Monster i.e.	02	•	
	900	Super Sport	98-02	•	

					
MH	900		00-	•	
	916	Monster S4	01- 03	•	
	916	Sport Touring 4	99- 01	•	
	916	SFS	97- 98	•	
	944	Sport Touring	98-	•	
	944	ST2	97-	•	
	992	ST3	04-	•	
	992	ST3s ABS	06-	•	
	996	SFS	99- 01	•	
	996	Monster S4R	04-	•	
	996	ST4s	02- 06	•	
	996	ST4s ABS	03- 06	•	
	998	S	02	•	
	1000	Monster Dark i.e., s.i.e.	03- 06	•	
	1000	Monster i.e., s.i.e.	03- 06	•	
	1000	Monster S2R	06- 07	•	
	1000	Multistrada	07-	•	
	1000	Multistrada DS	03- 06	•	
	1000	1000 Multistrada S DS	05-	•	
	1000	Supersport DS	03- 06	•	
	1100	Hypermotard EVO	10-	•	
	1100	Monster (Rad.cal)	09-	•	
	1100	Monster ABS (Rad.cal)	09-	•	
	1100	Monster EVO (Rad.cal)	11-	•	
	1100	Monster EVO ABS (Rad.cal)	11-	•	
	1100	Monster S ABS (Rad.cal)	09-	•	
	1100	Multistrada	07- 09	•	
	1100	Multistrada S	07- 09	•	
	1200	Multistrada	10- 14	•	
	1200	Multistrada SGT	12- 14	•	
	1200	Multistrada S Pikes Peak	11- 14	•	
	1200	Multistrada S Sport	10- 14	•	
	1200	Multistrada S Touring	10- 14	•	
<b>HONDA</b>					
CB	400		97-	•	
<b>HOREX</b>					
VR6	1200		11- 16	•	
<b>HUSQVARNA</b>					
	570	Nox	01- 03	•	
LT	610		00-	•	
SM	610	Super Motard, S	98-	•	
SMR	630		04- 08	•	
	900	Nuda	12-	•	
<b>KTM</b>					
SMC	625		05-	•	
	640	Duke	03- 06	•	
LC4	640	Supermoto	04-	•	
SMC	660	Supermoto	04- 07	•	
	690	Duke ABS	12-	•	
	1050	Adventure	15-	•	
	1090	Super Adventure	17-	•	
	1090	Super Adventure R	17-	•	
	1190	Adventure	13-	•	
	1290	Super Adventure	15- 16	•	
	1290	Super Adventure R	17-	•	
	1290	Super Adventure S	17-	•	
	1290	Super Adventure T	17-	•	
<b>MOTO-GUZZI</b>					
	750	Breva	03-	•	









	750	Nevada Classic ie	06-	•
	750	Nevada, Nevada Club	03-	•
V7	750	Cafe Classic	10-	•
V7	750	Classic	09- 12	•
V7	750	Clubman Racer	10-	•
V7	750	Racer	11- 14	•
V7	750	Stone	12- 14	•
V7 II	750	Racer	15-	•
V7 II	750	Scrambler	16-	•
V7 II	750	Special	15-	•
V7 II	750	Stone	15-	•
V7 II	750	Stornello	16-	•
V7 II	750	Stornello Ltd. Edition	17-	•
V7 III	750	Anniversario	17-	•
V7 III	750	Racer	17-	•
V7 III	750	Special	17-	•
V7 III	750	Stone	17-	•
V9	850	Bobber	16-	•
V9	850	Roamer	16-	•
V9	850	X-Track	17-	•
	940	Custom	07-	•
	1100	California EV	06-	•
	1100	California EV Touring	06-	•
	1100	California Jackal	01-	•
	1100	California Jackal Basic	01-	•
	1100	California Special	01-	•
	1100	California Special Sport Alloy	02-	•
	1100	California Stone Metal	02-	•
	1100	California Stone, Stone Touring	02-	•
	1100	California Titanium	03-	•
	1100	California Vintage	06-	•
	1100	Griso	05-	•
EV	1100	California 80 Touring	01-	•
V	1100	Breva	04	•
V	1100	Breva, ABS	05- 07	•
V11	1100	Scura, Sport Scura	02-	•
V11	1100	Lemans, Lemans Tenni, Lemans Rosso Corsa	01-	•
V11	1100	Sport Rosso Mandell	01-	•
V11	1100	Sport, Sport Naked	01-	•
	1200	Griso 8V	07-	•
	1200	Norge	06-	•
	1200	Norge GTSV	10-	•
	1200	Sport	07- 08	•
	1200	Sport 4V	09- 11	•
	1200	Sport 8V	12-	•
	1200	Sport 8V SE	12-	•
	1200	Stelvio	08- 11	•
	1200	Stelvio 8V SE	12-	•
	1200	Stelvio NIX	09- 11	•
V	1200	Breva	08-	•
	1400	Audace	16-	•
	1400	California Custom	13-	•
	1400	California Touring	13-	•
	1400	California Touring SE	16-	•
	1400	Eldorado Flying Fortress	16-	•

**MOTO-MORINI**

	1200	9 1/2	06- 09	•
	1200	Corsaro	06- 13	•



					
	1200	Sport	08-	•	
<b>MV AGUSTA</b>					
	675	Brutale	12-	•	
	675	F3	11- 14	•	
	800	Brutale	13-	•	
	800	Brutale Dragster	15-	•	
	800	Brutale Dragster RC	17-	•	
	800	Brutale Dragster RR	15-	•	
	800	Brutale RR	15-	•	
	920	Brutale	12- 14	•	
	989	Brutale R	09	•	
	990	Brutale R	10- 11	•	
	1090	Brutale R	12-	•	
<b>MZ</b>					
	1000	(MUZ)S	01- 02	•	
<b>NORTON</b>					
	961	CommandoSE	10- 11	•	
	961	CommandoSF Sport	11-	•	
<b>SUZUKI</b>					
GSX	1200		99- 01	•	
<b>VICTORY</b>					
		EmpulseTT	16-	•	
	1500	Kingpin	04- 05	•	
	1500	Touring Cruiser	03- 06	•	
	1500	V92C Cruiser	98- 02	•	
	1500	V92C Deluxe	01- 02	•	
	1500	V92SC Sport Cruiser	00- 02	•	
	1500	Vegas	03- 05	•	
	1500	Vegas 8-Ball	05	•	
	1634	Hammer	05- 07	•	
	1634	HammerS	06- 08	•	
	1634	Kingpin	06- 07	•	
	1634	Kingpin Tour	06- 07	•	
	1634	Vegas	06- 07	•	
	1634	Vegas 8-Ball	06- 07	•	
	1634	Vegas Jackpot	06- 07	•	
<b>VOXAN</b>					
VBI	1000	EVO	04-	•	
<b>YAMAHA</b>					
XJR	400	R	95-	•	
XT	660	X	04- 13	•	
TRX	850	(Italy)	95-	•	
XJR	1200	(Italy)	95- 98	•	

# Brake Pads

3094 ORGANIC

4094 SINTERED

5094 CERAMIC

A 51,2 | L 69,1 | S 8,7

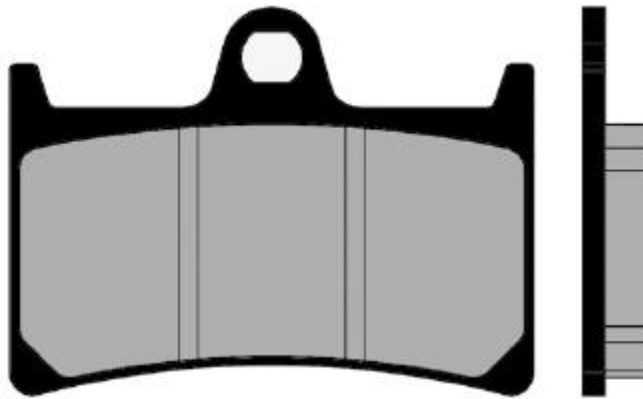

## YAMAHA

TZR	125		94	•
TZR	125	R	94-	•
TZR	250		89- 92	•
FZR	400	R	91-	•
XP	500	TMAX	08- 11	•
XP	500	TMAXTechMax	11	•
XP	530	TMAX	12-	•
XP	530	TMAX DX	17-	•
XP	530	TMAXIronMax	15-	•
XP	530	TMAX SX	17-	•
FZ6	600	Fazer S2	07-	•
FZ6	600	Fazer S2 ABS	07-	•
FZ6	600	S2	07-	•
FZ6	600	S2 ABS	07-	•
FZS	600	Fazer	98- 03	•
FZS	600	S Fazer	01- 03	•
YZF	600	R Thunder Cat	96- 03	•
YZF	600	R6	99- 04	•
YZF	600	R6 (Rad.cal)	05- 16	•
YZF	600	R6 (Rad.cal)	17-	•
MT-07	700		14-	•
MT-07	700	Moto Cage	15-	•
MT-07	700	Tracer	16-	•
XSR	700		16-	•
YZF	750	R7OW02	99- 02	•
	800	Fazer 8	10-	•
FZ8	800		10- 14	•
MT-09	900	(Rad.cal)	14-	•
MT-09	900	Sport Tracker (Rad.cal)	15-	•
MT-09	900	Street Rally (Rad.cal)	14-	•



MT-09	900	Tracer (Rad.cal)	15-	•
TDM	900		02- 14	•
XSR	900		16-	•
FZ1	1000	Fazer	06-	•
FZ5	1000	Fazer	01- 05	•
MT-10	1000		16-	•
MT-10	1000	SP	17-	•
YZF	1000	R Thunder Ace	96- 99	•
YZF	1000	R1	98- 03	•
YZF	1000	R1 (Rad.cal)	04- 06	•
YZF	1000	R1 (Rad.cal)	15-	•
YZF	1000	R1 SP (Rad.cal)	06	•
YZF	1000	R1M (Rad.cal)	15-	•
YZF	1000	R1S (Rad.cal)	16-	•
BT	1100	Bulldog	02- 06	•
XTZ	1200	Super Tenere	10-	•
XTZ	1200	Super Tenere ZE	14-	•
FJR	1300		01- 03	•
FJR	1300	ABS	03- 05	•
XJR	1300		99-	•
XJR	1300	Racer	15-	•
XJR	1300	SP	01	•
MT-01	1700	(Rad.cal)	05- 06	•
XV	1700	PC Road Star Warrior	03- 07	•
XV	1700	Road Star Warrior	02	•
XV	1900	A Midnight Star	06- 10	•





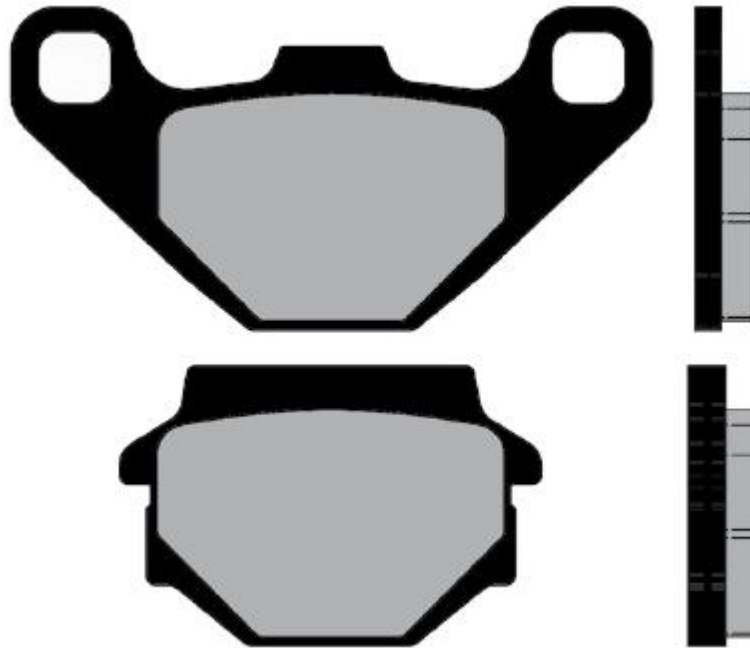

# 3095 ORGANIC







## Brake Pads

A 42,6 | L 85,0 | S 7,5  
A 37,0 | L 55,8 | S 9,7



<b>APRILIA</b>			
RX	125		90- •
RX	125		92 •
	125	Pegaso	92- 99 •
	125	Tuareg Rally	92 •
MX	125		04- 07 •
MX	125	Supermoto	07- •
SX	125		08- 13 •
	350	Tuareg Wind	90- •
	600	Pegaso	90- 92 •
	650	Pegaso	92- 94 •
<b>BATAVUS</b>			
		Grand Prix	80- •
<b>BOMBARDIER</b>			
	200	Rally 2x4	05- 06 •
<b>CAGIVA</b>			
WMX	50		89- •
<b>DERBI</b>			
DXR	200	Quad (Front disc)	04- •
DXR	200	Quad (Front disc)	04- •
DXR	250	Quad (Front disc)	04- •
DXR	250	Quad (Front disc)	04- •
<b>GAS GAS</b>			
	125	Enducross	93- •
<b>HUSABERG</b>			
		all models	89- 98 •

					
	350		91- 92		•
	500		91- 98		•
	501	Enduro			•
	600	Enduro			•
<b>HUSQVARNA</b>					
WRK	125		90		•
WRK	240		90		•
TE	350	Enduro	90		•
	510		90-		•
<b>KAWASAKI</b>					
KH	100	EX	88-	•	
KH	100	GH	83-	•	
AR	125		82- 94	•	
KE	125		86-	•	
KH	125		82- 98	•	
KX	125		83- 85	•	
KX	125		86	•	
KMX	125		86- 02		•
KX	125		87- 88	•	
KDX	200	C	86- 88	•	
KDX	200	SR	89- 92	•	
KMX	200		88- 90		•
Z	200		83-	•	
GPZ	250	Belt Drive	83- 84	•	
KL	250	(KLR 250)	85- 97	•	
KR	250		85	•	
KX	250		83- 85	•	
	250	Estrella	92-		•
KL	250	Super Sherpa	00-		•
KX	250		86		•
KX	250		87- 88		•
KXT	250	Tecate	85- 86		•
ZR	250	Balius	91- 95		•
ZZR	250		90- 01		•
Z	250	T, Scorpion	89-	•	
KLF	300	Bayou	88-	•	
GPZ	305		81- 96	•	
KLR	350		85-	•	
FX	400	R	86- 88	•	
GPZ	400		85- 87	•	
LX	400	Eliminator, SE	90	•	
EX-4	400		95-		•
KLE	400		91-	•	
ZR	400	Xanthus (ZR400D1)	92- 95		•
Z	400	F	84-	•	
ZR	400	F	83- 84	•	
ZX	400		85	•	
GPZ	500	S	88	•	
GPZ	500	S	89- 92	•	
KX	500		83- 85	•	
KX	500		86	•	
ZR	500	(Z 500 F)	83-	•	
EX	500		94- 96		•
EX	500	Ninja	94- 97		•
GPZ	500		95- 96		•
GPZ	500		97-		•
GPZ	500	S (Austria)	94-		•
KL	500	Tengai (Austria)	89- 91		•
KLE	500		91-		•

					
KLR	500	(Austria)	87- 88		•
KX	500		86		•
KX	500		87- 88		•
KX	550	A	83-	•	
Z	550	F	83-	•	
Z	550	GT	83-	•	
ZR	550	A1,GP	83- 84	•	
KL	600		84- 86	•	
KLR	600		84- 86	•	
KLR	600	E	85- 94	•	
KLR	650		87- 07		•
KLR	650		95- 04		•
KLR	650	Tengai	89- 92		•
<b>KTM</b>					
		GS,EXC, Enduro Models	91		•
GS	125		89- 90	•	
MX	125	600 ccm.	91	•	•
MX	125		89- 90	•	
GS	125		92- 97		•
GS	250		89- 90		•
MX	250		89- 90	•	
GS	250		89- 90	•	•
EXC	300		93- 96		•
MX	300		90	•	•
MX	300		92-		•
LC4	350		92-	•	•
LC4	400		93- 02		•
MX	500		89- 91	•	
LC4	600	Six Days	92-		•
<b>KYMCO</b>					
	125	Agility City	11-		•
<b>LAVERDA</b>					
	700	El Cid	90	•	•
<b>MAICO</b>					
		all models	91		•
<b>MALAGUTI</b>					
F-10	50		92- 93	•	
<b>PEUGEOT</b>					
SV	50	Roland Garros	93-	•	
SV	50	Sport	93-	•	
	125	Django Allure	14-		•
	125	Django Evasion	14-		•
	125	Django Sport	14-		•
	150	Django Allure	14-		•
	150	Django Evasion	14-		•
	150	Django Sport	14-		•
<b>POLARIS</b>					
	200	Phoenix	05-		•
<b>SUZUKI</b>					
	50	Wolf	89-	•	
GSXR	50		87-	•	
OR	50	E	80-	•	
RG	50	GAG	87-	•	
RG	50	Gamma	90-	•	
TV	50	Wolf	89-	•	
ZR	50		81- 87	•	
RB	50		87	•	
GT	80	L/C	81-	•	
RG	80	Gamma	- 87	•	



TR5	118		82- 83	•
GN	125		91- 04	•
GS	125	ESZ	82-	•
GT	125		80-	•
TR	125		83-	•
TU	125	XT	99-	•
X4	125	X3E		•
ET	240		86-	•
NZ	250		86-	•
GSX	400	EFX	82	•
GSX	400	FD	83	•
GSX	400	FX, FZ	81- 82	•
GSX	400	S, Katana	83-	•
GS	450		86	•
<b>SYM</b>				
	125	Husky	96- 98	•
<b>YAMAHA</b>				
YFM	90	RY Raptor	09-	•

# Brake Pads

3096 ORGANIC  
4096 SINTERED

A 40,1 | L 115,7 | S 8,4

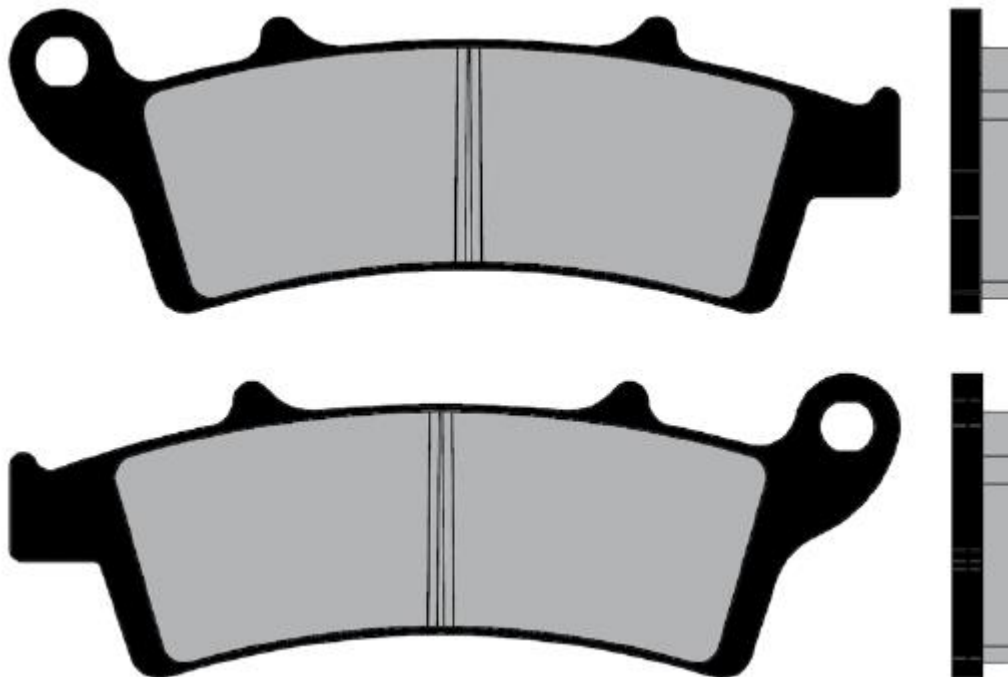

## APRILIA

125	Atlantic	03-	•
125	Scarabeo, Scarabeo GT	04-	•
150	Scarabeo, Scarabeo GT	04-	•
200	Atlantic	03-	•
200	Scarabeo	07-	•
200	Scarabeo Class	10-	•
200	Scarabeo ie	12-	•
250	Atlantic ie	07-	•
250	Scarabeo, Scarabeo ie	06-	•
300	Scarabeo Special	10-	•
500	Atlantic Sprint	06-	•

## KYMCO

125	K-XCTi	14-	•
125	NewDowntown	16-	•
125	PeopleGfi	12-	•
125	X-Town	16-	•
200	PeopleGfi	12-	•
300	K-XCTi	12-	•
300	PeopleGfi	12-	•
300	X-Town	16-	•
350	NewDowntown	16-	•

## MALAGUTI

250	Madison	99-	•
400	Madison	02-	•

## PIAGGIO

350	Beverly Sport Touring i.e.	12-	•
-----	----------------------------	-----	---



# 3097 ORGANIC

Brake Pads

A 41,2 | L 96,8 | S 9,0  
A 41,2 | L 77,0 | S 9,0

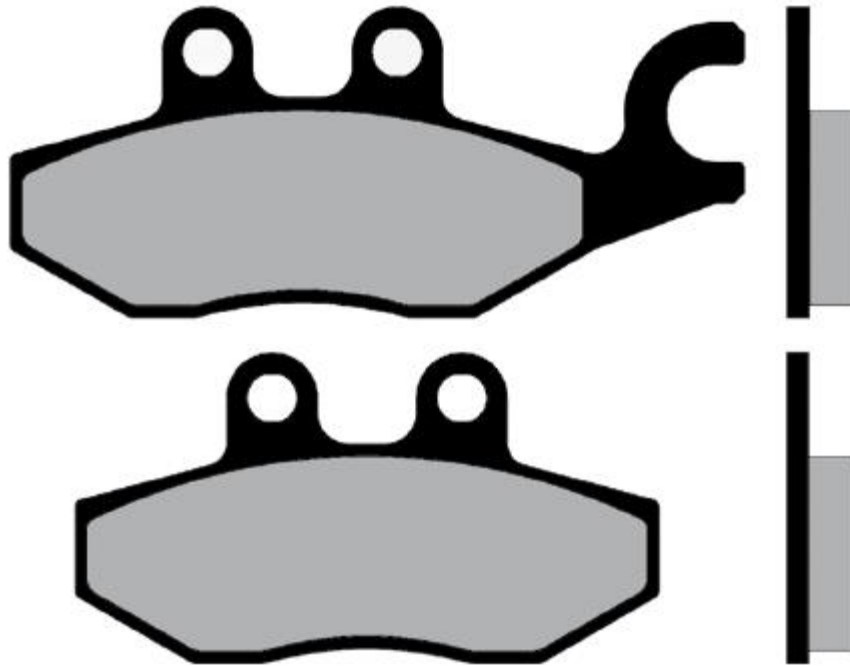

## PIAGGIO

125	Medley	16-	•
125	Medley S	17-	•
125	MP3 Efi	08- 11	•
125	MP3 Hybrid	09- 12	•
125	MP3 Yourban	11- 12	•
125	X10 Executive Left/Rear	13-	•
125	X10 Executive Right	13-	•
125	X7	08-	•
125	X9 Evolution Right	06-	•
125	X9 Right	04-	•
125	Xevo	08-	•
150	Medley	16-	•
250	MP3 Efi	08- 09	•
250	MP3LT iE	09	•
250	X7	08-	•
250	X9 Right	05-	•
250	Xevo	08-	•
300	Beverly i.e.	11-	•
300	MP3 Hybrid	11-	•
300	MP3 Hybrid iE	11-	•
300	MP3 iE	10-	•
300	MP3LT	13-	•
300	MP3 LT Business	13-	•
300	MP3LT iE ABS	14-	•
300	MP3LT Sport ABS	14-	•



	300	MP3LTouring	11- 12		•
	300	MP3 Touring	11- 12		•
	300	MP3 Yourban iE	11-		•
	300	X7 Evo i.e.	11-		•
	350	Beverly S	14-		•
	350	Beverly Sport Touring ie	12-		•
	350	Beverly Sport Touring ie ABS	12-		•
	350	X10 Executive Left/Rear	13-		•
	350	X10 Executive Right	13-	•	
BV	350		12-		•
	400	X8 Right	07-	•	
	400	Xevo Right	08-	•	
	500	X10 Executive Left/Rear	13-		•
	500	X10 Executive Right	13-	•	

# Brake Pads

3098 ORGANIC  
4098 SINTERED

A 55,5 | L 68,5 | S 8,8

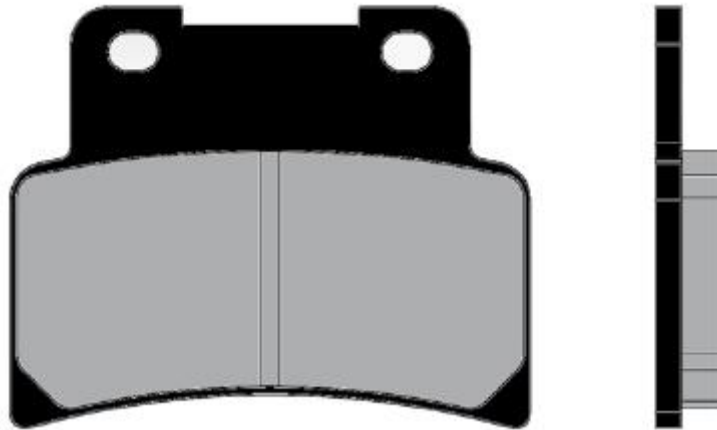

## APRILIA

RS	125		06-	•
SL	750	ShiverGT, ABS	09-	•
SL	750	Shiver, ABS	07-	•
SMV	750	Dorsoduro	09- 16	•
NA	850	Mana	07	•
NA	850	ManaGT, ABS	09- 13	•
NA	850	Mana, ABS	08- 11	•
	900	Dorsoduro	17-	•
	900	Shiver	17-	•

## KYMCO

	400	Xciting i	12-	•
--	-----	-----------	-----	---

## SYM

	400	Maxsym	11	•
--	-----	--------	----	---

## YAMAHA

MT	125		14-	•
YZF	125	R	14-	•

# Brake Pads

3099 ORGANIC

4099 SINTERED

A 42,9 | L 85,3 | S 8,2

A 41,0 | L 71,6 | S 8,2

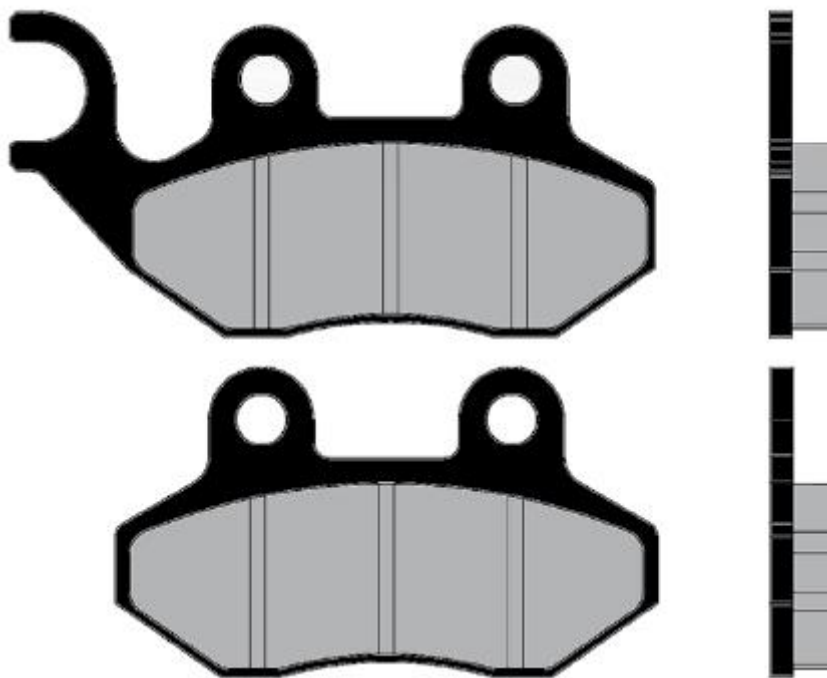

## CAGIVA

	50	City	95-	•
--	----	------	-----	---

## GARELLI







KRS	50		02-	•
PMX	50	Sport	00-	•
	125	Freeland	02-	•
	125	T-Rex	00-	•
	150	Freeland	02-	•

## PEUGEOT

	50	Tweet	10- 13	•
	50	Tweet Evo	14-	•
	50	Tweet Evo RS	14-	•
	50	Tweet RS	10- 13	•
	125	Tweet	10- 13	•
	125	Tweet Evo	14-	•
	125	Tweet Evo RS	14-	•
	125	Tweet RS	10- 13	•
LXR	125		10-	•
	150	Tweet	10- 13	•
	150	Tweet RS	10- 13	•
LXR	200		10-	•

## PGO

		i-Dep	09-	•
	50	Dr. Big	01-	•
	50	G-Max	06-	•
	50	Libra	10-	•

					
	50	Ligero	06-	•	
	50	T-Rex	99-	•	
PMS	50		99-	•	
PMX	50	Naked	06-	•	
PMX	50	Sport	01-	•	
	100	My Bubu	02-	•	
	110	T-Rex	99-	•	
	125	Charge A, B	02-	•	
	125	Ligero	06-	•	
	125	My Bubu, Young Bubu	02-	•	
	125	T-Rex (2 stroke)	99-	•	
	125	T-Rex (4 stroke)	99-	•	
	150	TR3	02-	•	
	150	T-Rex	01-	•	
<b>SYM</b>					
	50	Allo	11-	•	
	50	Crox	14-	•	
	50	Fiddle	09-	•	
	50	Fiddle III	16-	•	
	50	Jet 4 Naked	11-	•	
	50	Jet 4 R	11-	•	
	50	Jet BasiX	07-	•	
	50	Jet Euro X	05-	•	
	50	Jet Sport X	06-	•	
	50	Jet Sport X SR	06-	•	
	50	Jet, Alpha	95-	•	
	50	Jungle	96-	•	
	50	Mask	00-	•	
	50	Mask LC	00-	•	
	50	Orbit II	12-	•	
	50	Red Devil	97-	•	
	50	Super Fancy	95- 97	•	
	50	Symphony	09-	•	
	50	Symphony SR	11-	•	
	50	Symphony SI	15-	•	
	50	Symply	08-	•	
	50	XPro	14-	•	
	100	Jet	00-	•	
	100	Jet Euro X	05-	•	
	100	Jet Sport X	05-	•	
	100	Party	97-	•	
	100	Super Fancy	95-	•	
	110	Star	03-	•	
	125	Allo	11-	•	
	125	Attila	95-	•	
	125	Citycom	09-	•	
	125	Crox	14-	•	
	125	Fiddle	09-	•	
	125	Fiddle III	16-	•	
	125	Jet 14	17-	•	
	125	Jet 4	11-	•	
	125	Megalo	02-	•	
	125	New Duke	02- 07	•	
	125	Super Duke	95- 01	•	
	125	Symphony	09-	•	
	125	Symphony EX	17-	•	
	125	Symphony S	11-	•	
	125	Symphony SR	11-	•	
	125	Symphony SI	15-	•	



	125	Symply	08-	•	
	125	XPro	14-	•	
HD	125	EvoDT	10-	•	
HD2	125	Evo	14-	•	
H01	150		95-	•	
	150	Attila	00-	•	
	150	Crox	14-	•	
	150	Jet 4	11-	•	
	150	Super Duke	96- 01	•	
	150	Symphony S	11-	•	
	150	Symphony SR	11-	•	
	200	Fiddle II	11-	•	
	200	Fiddle III	16-	•	
	200	Joyride Evo	09-	•	
HD	200	Evo	07-	•	
HD2	200	Evo	14-	•	
	300	Citycom	09-	•	•
	300	Citycom S	15-	•	•
<b>ZERO</b>					
DS		ZF6.0	10- 12	•	
DS		ZF9.0	10- 12	•	
MX			10- 12	•	
S		ZF6.0	10- 12	•	
X			10- 12	•	
XU			11- 12	•	

# 3100 ORGANIC

## Brake Pads

A 36,1 | L 94,0 | S 10,3

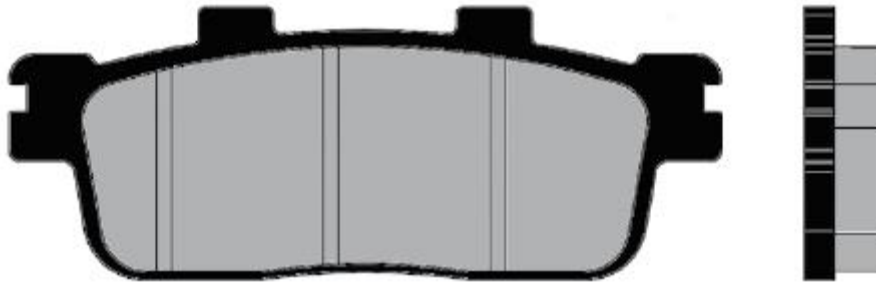

### DAELIM

ST	250	Sector Quad	05- 06	•
----	-----	-------------	--------	---

### E-TON







RXL	150	Viper	07-	•
VXL	250	ST Vector	06-	•
VIX	300	ST Vortex	07-	•
VXL	300	ST Vector	07-	•

### PEUGEOT

LXR	125		10-	•
LXR	200		10-	•

### SYM

	125	Joymax Sport	16-	•
	125	Joyride	07- 09	•
	125	Joyride Evo	10-	•
	125	Joyride S	16-	•
HD	125	Evo DT	10-	•
HD2	125	Evo	14-	•
SB	125	WolfNi	11-	•
	200	Joyride S	16-	•
HD	200	Evo	07-	•
HD2	200	Evo	14-	•
	200	Quaflander	12-	•
	200	Trackrunner	05- 08	•
	250	GTS	07-	•
	250	Joymax	07-	•
	250	Joymax Sport	16-	•
RV	250	Efi	10-	•
	250	Quaflander	06- 07	•
	300	City Max	06- 07	•
	300	Cruisym	17-	•
	300	Joymax Evo	10-	•
	300	Joymax Sport	16-	•
	300	Joyride Evo i	10-	•
GIS	300		09-	•

					
GIS	300	Evo i	11-		•
<b>TGB</b>					
	125	X-Large	11-		•
	125	X-Motion	08-		•
	250	X-Motion	08-		•
	300	X-Motion	10-		•



# Brake Pads

3101 ORGANIC  
4101 SINTERED  
6101 OFF ROAD

A 36,0 | L 66,9 | S 9,3

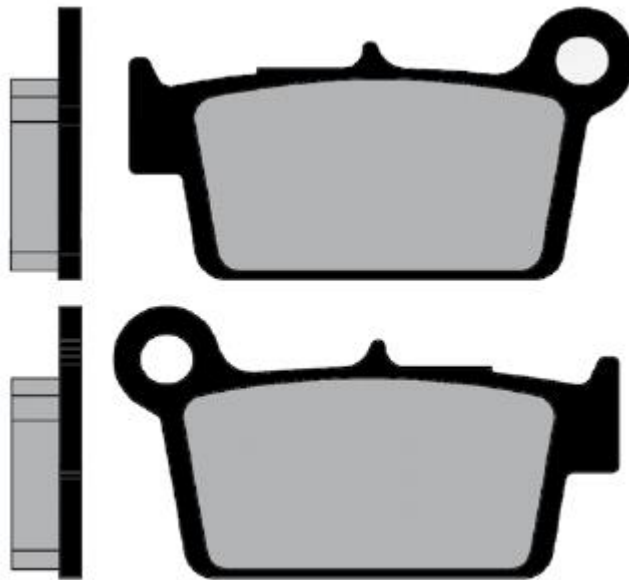







## APRILIA

MXV	450		09-	•
RXV	450		06-	•
SXV	450		06-	•
SXV	450	Van den Bosch Rep.	08-	•
RXV	550		06-	•
SXV	550		06-	•
SXV	550	Van den Bosch Rep.	08-	•

## BETA

RR	250		05-	•
	300	Crosstrainer	15-	•
RR	300		13-	•
RR	350	Efi	15-	•
RR	350	Efi Racing	15-	•
RR	350	Enduro	12- 14	•
RR	390		15-	•
RR	400	Enduro	05-	•
RR	430		15-	•
RR	430	Racing	15-	•
RR	450	CrossCountry	12-	•
RR	450	Enduro	05-	•
RR	480		15-	•
RR	480	Racing	15-	•
RR	498	Enduro	12-	•
RR	525	Enduro	05-	•

## BIMOTA

					
BBX	300	Enduro	12-		•
<b>CCM</b>					
	450	MX	08- 10		•
<b>GAS GAS</b>					
EC	200		17-		•
EC	250		12- 16		•
EC	250		17-		•
XC	250		17-		•
EC	300		12- 16		•
EC	300		17-		•
<b>HM</b>					
CRE	50	Six Comp.	07- 12		•
CRM	50	Derapage Comp.	07- 12		•
CRE	125	Six Comp.	10- 11		•
CRM	125	Derapage Comp. 2T	11- 12		•
CRM	125	Derapage Comp. 4T	11- 12		•
<b>KAWASAKI</b>					
KX-F	250		04- 10		•
KX-F	250	DFI	11-		•
KLX	450	R	07-		•
KX-F	450		06- 08		•
KX-F	450	DFI	09-		•
<b>SHERCO</b>					
SE	250	2.5i Enduro	06- 11		•
SX	250	2.5i-F	09- 11		•
SE	300	3.0i-F	10- 11		•
SE	450	4.5i Enduro	05- 11		•
SM	450	4.5i Supemotard	06-		•
SE	510	5.1i Enduro	06- 11		•
<b>SUZUKI</b>					
RM-Z	250		04- 06		•
RM-Z	250		07- 09		•
RM-Z	250	Efi	10-		•
RMX	450	Z Efi	10		•
RMX	450	Z Efi	17-		•
RM-Z	450		05- 07		•
RM-Z	450	Efi	08-		•
<b>TM</b>					
	125		05-		•
	125	Enduro	05-		•
	250		05-		•
	250	Enduro	05-		•
	250	F	05-		•
	250	F Enduro	05-		•
	300		05-		•
	300	Enduro	05-		•
	450	F	05-		•
	450	F Enduro	05-		•
FT	450	Fi	17-		•
	530	F	05-		•
	530	F Enduro	05-		•
<b>YAMAHA</b>					
YZ	125		03-		•
WR	250	F	03- 13		•
WR	250	F Efi	15-		•
WR	250	R	08-		•
WR	250	X	08-		•
YZ	250		03-		•
YZ	250	F	03- 13		•



YZ	250	F Efi	14- 15	•
YZ	250	F Efi	16-	•
YZ	250	FX Efi	15-	•
WR	450	F	03- 15	•
WR	450	F Efi	16-	•
YZ	450	F	03- 09	•
YZ	450	F Efi	10- 15	•
YZ	450	F Efi	16-	•
YZ	450	FX Efi	16-	•

**ZERO**

DS		ZF11.4	13	•
DS		ZF8.5	13	•
FX		ZF2.8	13	•
FX		ZF5.7	13	•
MX		ZF2.8	13	•
MX		ZF5.7	13	•
S		ZF11.4	13	•
S		ZF8.5	13	•
XU		ZF2.8	13	•
XU		ZF5.7	13	•

# Brake Pads

3102 ORGANIC  
4102 SINTERED

A 36,1 | L 94,0 | S 10,3

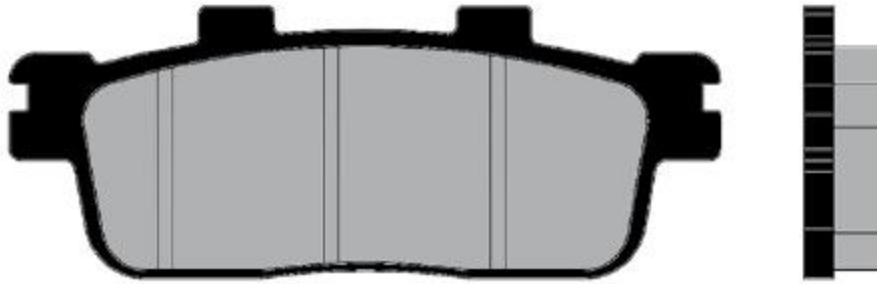

## KYMCO

	125	G-Dink	12-	•
	125	K-XCTi	14-	•
S	125	People	05-	•
S	200	People	05-	•
	250	Xciting	06-	•
S	250	People Left/Rear	06-	•
	300	G-Dink	12-	•
	300	K-XCTi	12-	•
	300	People Si Left/Rear	08-	•
	300	Xciting Ri	08-	•

## YAMAHA

YP	400	400 RX-Max	13-	•
YP	400	400 RA X-Max	14-	•

# Brake Pads

3103 ORGANIC  
4103 SINTERED

A 33,3 | L 90,0 | S 9,8

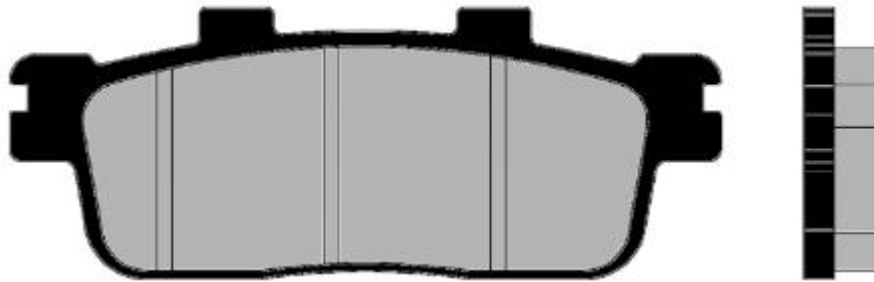

**KAWASAKI**

J	125		16-	•
J	300		14-	•

**KYMCO**

	125	Downtown	10-	•
	125	New Downtown	16-	•
	125	People GFi	12-	•
	125	Super Dink	10-	•
	125	X-Town	16-	•
	200	Downtown	10-	•
	200	People GFi	12-	•
	300	Downtown	10-	•
	300	People GFi	12-	•
	300	X-Town	16-	•
	350	New Downtown	16-	•

# Brake Pads

3104 ORGANIC  
4104 SINTERED

A 46,2 | L 88,0 | S 8,3

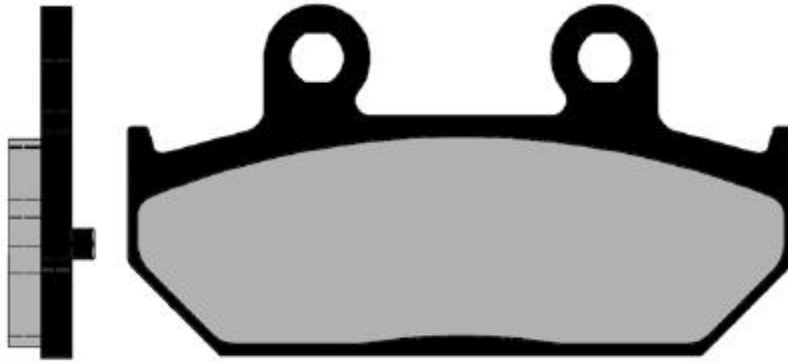

## SUZUKI

AN	400	Burgman Left/Rear	07- 16	•
AN	400	Burgman Left/Rear	17-	•
AN	650	A Burgman Executive	04- 12	•
AN	650	Burgman	02-	•
AN	650	Z Burgman Executive	13-	•



# Brake Pads

3106 ORGANIC  
4106 SINTERED

A 45,2 | L 46,1 | S 7,7

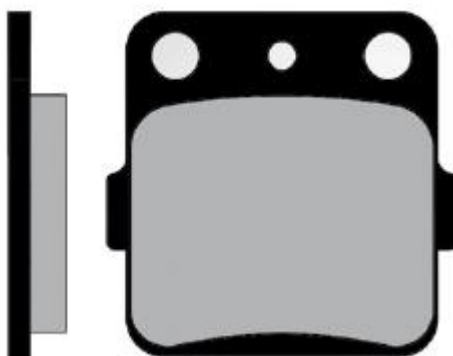

## HONDA

CR	80	R	86- 91	•	
CR	80	R, RB	92- 02	•	
CRM	80		89-	•	
CR	85	R, RExpert	03-	•	
CRF	150	R	07-	•	
ATC	200	X	83- 85	•	•
TRX	250	EXSportrax	01- 08	•	
ATC	250	R	82- 84	•	
ATC	250	X	85		•
TRX	250	X	08-	•	
TRX	300	EXSportrax	01- 08	•	•
TRX	300	X	09-	•	•
ATC	350	X	85-		•
TRX	400	EXSportrax	01- 08	•	•
TRX	400	FourtraxEX	99- 00	•	•
TRX	400	X	09- 12	•	•
TRX	420	FA / FPA	09-	•	
TRX	420	FPE / FPM4x4	09-	•	
TRX	450	EXSportrax	01-	•	•

## KAWASAKI

KX	80		88- 00		•
KX	85		01-		•
KX	85	II	01- 13		•
KX	100		88- 92		•
KX	100		95-		•
KLX	140	L	08-		•
KSF	250	Mojave	87-		•
KXF	250	Tecate	87- 88		•
KXT	250	Tecate	87-		•
KEF	300	Lakota	95-		•





KFX	400		02-	•	
KFX	450	Left/Rear	07-		•
<b>SUZUKI</b>					
RM	100		03-		•
RM	125		88		•
LT	230		85- 88		•
LT	230		86- 93		•
LT	250		85- 87		•
LT	250		89- 90		•
RM	250		87- 88		•
LT-Z	400	Quad Sport	02-	•	
RM	500		87-		•
DR-Z	800		88- 90		•
<b>TM</b>					
	80	Junior	96- 00		•
<b>YAMAHA</b>					
YZ	80		93- 01		•
YZ	85	LW	02-		•
YZ	125		89		•
YFS	200	R Blaster	03- 06		•
YFM	250	Raptor Left/Rear	09-		•
YZ	250		89		•
YFM	300	Warrior	89		•
YFM	350	FXG,FXM Wolverine	95-		•
YFM	350	R Raptor	04-	•	•
YFM	350	XG,XH Warrior	95- 96		•
YFM	350	XI,XU Warrior	87- 88		•
YFZ	350	Banshee	87- 06		•
YZ	360		89		•
YFZ	450	S Left/Rear	04- 05		•
YFM	600	4x4 Grizzly	98- 01	•	
YFM	660	FWAP 4x4 Grizzly	02-	•	
YFM	660	RN Raptor	01-	•	•

# Brake Pads

3107 ORGANIC

4107 SINTERED

5107 CERAMIC

A 40,5 | L 34,9 | S 7,5

serie da 4 pz

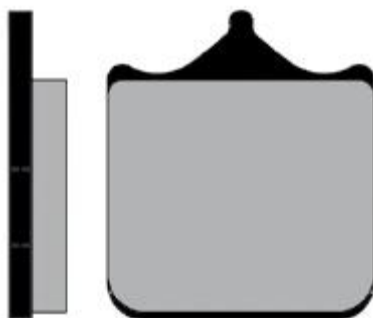

## APRILIA







RSV	1000	Factory Pista (Rad.cal)	04-	•
RSV	1000	Mille	02- 03	•
RSV	1000	Mille Nera (Rad.cal)	04-	•
RSV	1000	Mille R	01- 02	•
RSV	1000	Mille R	04	•
RSV	1000	Mille R (Rad.cal)	03	•
RSV	1000	Mille R (Rad.cal)	05-	•
RSV	1000	Mille R Factory (Rad.cal)	04-	•
RSV	1000	Tuono R	03	•
RSV	1000	Tuono R Factory, ABS	06-	•

## BENELLI

BX	449	Supemotard	08-	•
BN	600		14-	•
BN	600	GT	14-	•
	756	Cue	07- 09	•
TnT	899	Century Racer	11-	•
	900	Tomado TRE	03- 06	•
	900	Tomado TRE RS (Rad.cal)	04- 06	•
TnT	1130	Cafe Racer	05-	•
TnT	1130	Century Racer	11-	•
TnT	1130	Officine	07-	•
TnT	1130	Sport	05-	•
TnT	1130	Titanium	05-	•

## BIMOTA

DB5	1000	Mille (Rad.cal)	05- 11	•
DB5	1000	S (Rad.cal)	07- 11	•
DB6	1000	Delirio (Rad.cal)	07-	•
SB8K	1000	Santamonica	07-	•
DB10	1078	Bimotard	12-	•
DB5	1078	RE	12-	•

					
DB7	1098	(Rad.cal)	08	•	
3D	1100	Tesi (Rad.cal)	07-	•	
DB6R	1100	Delirio (Rad.cal)	08-	•	
DB12	1200		12-	•	
DB9	1200	Brivido	12-	•	
<b>BMW</b>					
G	450	SMR	09- 10	•	
<b>BREMO RACING CALIPERS</b>					
<b>CAGIVA</b>					
	1000	X3 Raptor	03-	•	
	1000	X-Raptor	04-	•	
<b>DERBI</b>					
	659	Mulhacen	06- 07	•	
	659	Mulhacen Cafe	08-	•	
<b>DUCATI</b>					
	748	R	01- 02	•	
	749	S	03- 07	•	
	749	R (Rad.cal)	04- 07	•	
	996	R	01	•	
	998	Monster S4RS	06	•	
	998	R	02	•	
	999	S	03- 07	•	
	999	Monster S4R	07-	•	
	999	Monster S4RS	07-	•	
	999	R (Rad.cal)	03- 07	•	
	1000	Hypermotard	06	•	
<b>GILERA</b>					
	600	Supersport	02-	•	
<b>HUSQVARNA</b>					
SMR	449		11-	•	
SM	450	R	05	•	
SM	450	R	06-	•	
SM	450	RR	06-	•	
SM	510	Centennial	06-	•	
SM	510	R	05-	•	
SMR	511		11-	•	
SM	610	ie	07-	•	
SM	630		10-	•	
SIR	650	CRC	07-	•	
SM	701	Supermoto	15-	•	
<b>HYOSUNG</b>					
RX	450	SM	08-	•	
<b>KTM</b>					
	690	Duke	08- 11	•	
	690	Duke R	10- 11	•	
	690	SM	07-	•	
	690	SMC	08-	•	
	690	Supermoto R	08-	•	
	950	SM	05-	•	
	950	SMR	07-	•	
	990	Super Duke	04- 13	•	
	990	Super Duke R	09- 13	•	
	990	Supermoto	07- 11	•	
	990	Supermoto T	09-	•	
<b>LAVERDA</b>					
SFC	1000	(Rad.cal)	04-	•	
<b>MONDIAL</b>					
	1000	EVO (Rad.cal)	04-	•	
	1000	Piega	03-	•	



	1000	RZNuda	04-	•
	1000	Starfighter (Rad.cal)	04-	•
<b>MOTO-GUZZI</b>				
	1200	MGS-01 Corsa (Rad.cal)	05-	•
<b>MOTO-MORINI</b>				
	1200	Granferro	10-	•
<b>MV AGUSTA</b>				
	1000	F4 R	06- 07	•
<b>NORTON</b>				
	961	Commando Cafe Racer	11-	•
	961	CommandoSE	12-	•
	961	CommandoSF	13-	•
<b>SHERCO</b>				
SM	450	4.5i Supermotard	06-	•
<b>SWM</b>				
SM	450	R	15-	•
	650	Superdual	15-	•
<b>TM</b>				
SMX	450	F	04-	•
SMX	660	F	04-	•
<b>TRIUMPH</b>				
	1050	Speed 94	15-	•
	1050	Speed Triple (Rad.cal)	08- 15	•

# Brake Pads

**3108 ORGANIC**  
**4108 SINTERED**

A 40,7 | L 82,1 | S 9,5  
 A 40,7 | L 62,0 | S 9,5

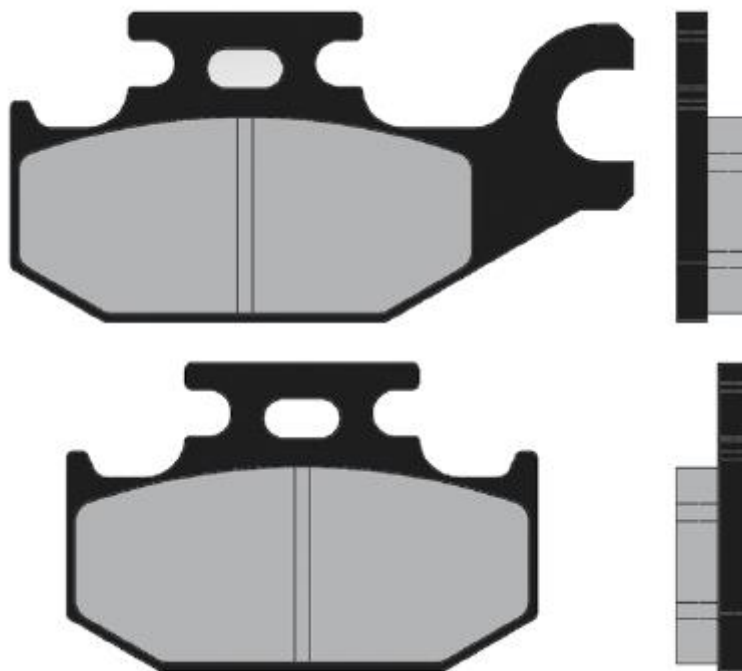

## BENELLI

	250	Caffenero Left/Rear	08-	•
--	-----	---------------------	-----	---

## SUZUKI

UH	125	Burgman	15- 16	•
UX	125	SIXteen	08-	•
UX	150	SIXteen	08-	•
UH	200	Burgman	07-	•

## BOMBARDIER

DS	250	Left/Rear	06	•	•
	330	Outlander Left/Rear	03- 06	•	•
	400	Outlander Left/Rear	03- 06	•	•
	400	Outlander Max Left/Rear	03- 06	•	•
	500	Quest Left/Rear	02- 06	•	•
	500	Traxter 4x4 Left/Rear	01- 06	•	
	500	Traxter Max Left/Rear	03- 05	•	
	650	Quest Left/Rear	02- 06	•	•
	650	Quest Max Left/Rear	03- 06	•	
	650	Traxter Max Left/Rear	03- 05	•	
DS	650	Left/Rear	01- 06	•	•
	800	Outlander Left/Rear	06	•	•
	800	Outlander XT Left/Rear	06	•	•

## CAN-AM

	400	Outlander Efi Left/Rear	09-	•
	400	Outlander MAXSID Left/Rear	07-	•
	400	Outlander MAXXT Left/Rear	07-	•
	400	Outlander SID Left/Rear	07-	•



400	Outlander XT Left/Rear	07-	•	
500	Outlander MAXSID Left/Rear	07- 12	•	
500	Outlander MAXXT Left/Rear	07- 12	•	
500	Outlander SID Left/Rear	07- 12	•	
500	Outlander XT Left/Rear	07- 12	•	
500	Renegade Left/Rear	08- 11	•	
650	Outlander MAXSID Left/Rear	07- 12	•	
650	Outlander MAXXT Left/Rear	07- 12	•	
650	Outlander SID Left/Rear	07- 12	•	
650	Outlander XT Left/Rear	07- 12	•	
800	Outlander MAXLTD Left/Rear	07- 11	•	
800	Outlander MAXSID Left/Rear	07- 11	•	
800	Outlander MAXXT Left/Rear	07- 11	•	
800	Outlander SID Left/Rear	07- 11	•	
800	Outlander XT Left/Rear	07- 11	•	
800	Renegade Efi Left/Rear	07- 11	•	
800	Renegade Left/Rear	08- 11	•	
800	Renegade X Left/Rear	08- 11	•	
1000	Commander MAX Left	14-		•
1000	Maverick Left	13-		•

**CANNONDALE**

440	Blaze Left/Rear	03	•	•
440	Cannibal Left/Rear	03	•	•
440	Glamis Left/Rear	03	•	•
440	Moto Left/Rear	03	•	•
440	Speed Left/Rear	03	•	•

**JOHN DEERE**

500	Buck EX, EXT Left/Rear	05-	•	
500	Buck Left/Rear	05-	•	
500	Trail Buck Left/Rear	05-	•	
650	Trail Buck EX, EXT Left/Rear	05-	•	
650	Trail Buck Left/Rear	05-	•	

**YAMAHA**

YFM	400	FAM Kodiak	00-	•
YFM	400	FWN Big Bear 4WD	00-	•
YFM	400	FWNH Big Bear-Buckmaster 4WD	00-	•
YFM	400	N Big Bear 2WD	00-	•
YFM	450	FA_ Kodiak	03-	•
YFM	450	Wolverine	06-	•

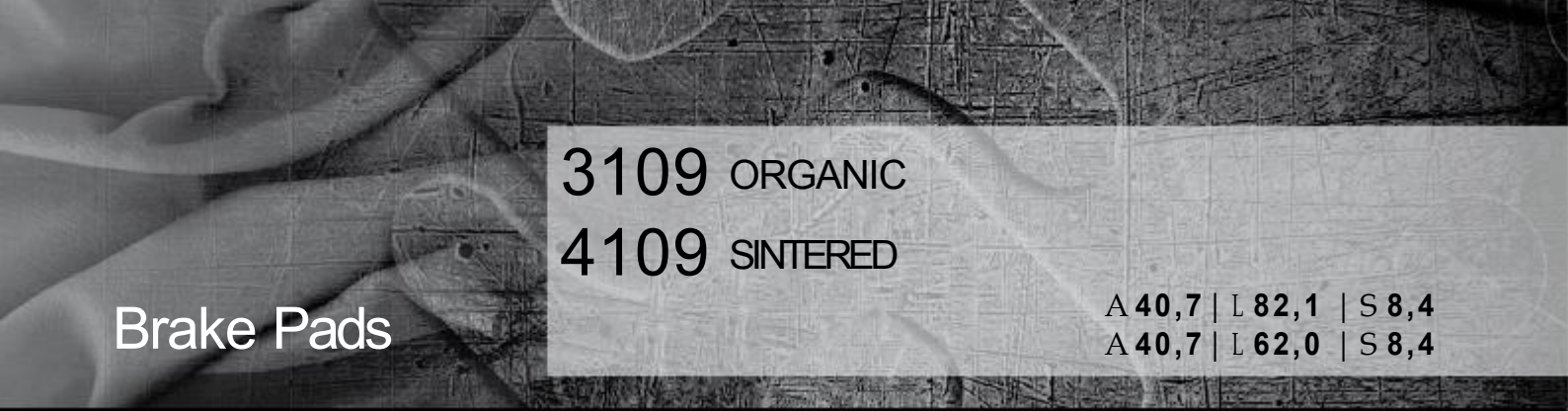

# Brake Pads

**3109** ORGANIC  
**4109** SINTERED

A **40,7** | L **82,1** | S **8,4**  
 A **40,7** | L **62,0** | S **8,4**

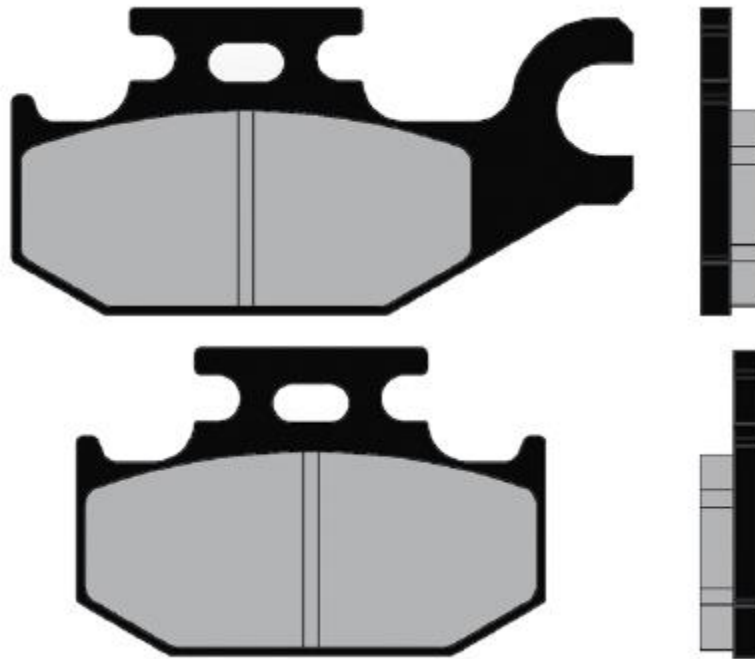

**SUZUKI**

KLT-A	400	King Quad Left	08-	•
KLT-F	400	King Quad Left	08-	•
LT-A	400	King Quad Left	08-	•
LTF	400	King Quad Left	08-	•
LT-A	450	King Quad Left	08-	•
LT-A	500	King Quad Left	11-	•
LT-A	700	King Quad Left	05-	•
LT-A	750	King Quad Left	08-	•

# Brake Pads

**3110 ORGANIC**  
**4110 SINTERED**

A 40,7 | L 82,1 | S 9,5  
 A 40,7 | L 62,0 | S 9,5

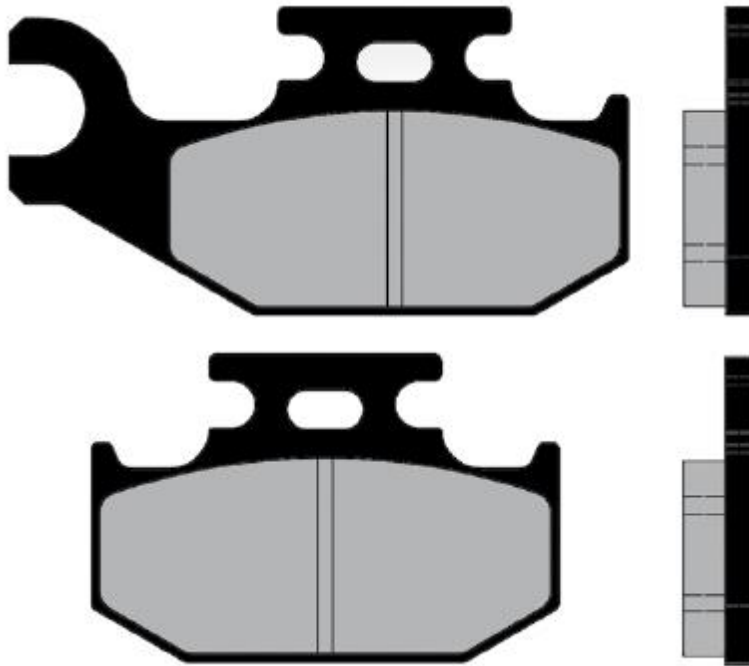

## BOMBARDIER

DS	250	Right	06	•	
	330	Outlander Right	03- 06	•	
	400	Outlander Max Right	03- 06	•	
	400	Outlander Right	03- 06	•	
	500	Quest Right	02- 06	•	
	500	Traxter 4x4 Left/Rear	01- 06		•
	500	Traxter 4x4 Right	01- 06	•	
	500	Traxter Max Left/Rear	03- 05		•
	500	Traxter Max Right	03- 05	•	
	650	Quest Max Left/Rear	03- 06		•
	650	Quest Max Right	03- 06	•	
	650	Quest Right	02- 06	•	
	650	Traxter Max Left/Rear	03- 05		•
	650	Traxter Max Right	03- 05	•	
DS	650	Right	01- 06	•	
	800	Outlander Right	06	•	
	800	Outlander XT Right	06	•	

## CAN-AM

	400	Outlander Efi Left/Rear	09-		•
	400	Outlander Efi Right	09-	•	
	400	Outlander MAXSID Left/Rear	07-		•
	400	Outlander MAXSID Right	07-	•	
	400	Outlander MAXXT Left/Rear	07-		•
	400	Outlander MAXXT Right	07-	•	
	400	Outlander SID Left/Rear	07-		•





400	Outlander STD Right	07-	•	
400	Outlander XT Left/Rear	07-		•
400	Outlander XT Right	07-	•	
500	Outlander MAXSID Left/Rear	07- 12		•
500	Outlander MAXSID Right	07- 12	•	
500	Outlander MAXXT Left/Rear	07- 12		•
500	Outlander MAXXT Right	07- 12	•	
500	Outlander STD Left/Rear	07- 12		•
500	Outlander STD Rogit	07- 12	•	
500	Outlander XT Left/Rear	07- 12		•
500	Outlander XT Right	07- 12	•	
500	Renegade	08- 11		•
500	Renegade Right	08- 11	•	
650	Outlander MAXSID Left/Rear	07- 12		•
650	Outlander MAXSID Right	07- 12	•	
650	Outlander MAXXT Left/Rear	07- 12		•
650	Outlander MAXXT Right	07- 12	•	
650	Outlander STD Left/Rear	07- 12		•
650	Outlander STD Right	07- 12	•	
650	Outlander XT Left/Rear	07- 12		•
650	Outlander XT Right	07- 12	•	
800	Outlander MAXLTD Left/Rear	07- 11		•
800	Outlander MAXLTD Right	07- 11	•	
800	Outlander MAXSID Left/Rear	07- 11		•
800	Outlander MAXSID Right	07- 11	•	
800	Outlander MAXXT Left/Rear	07- 11		•
800	Outlander MAXXT Right	07- 11	•	
800	Outlander STD Left/Rear	07- 11		•
800	Outlander STD Right	07- 11	•	
800	Outlander XT Left/Rear	07- 11		•
800	Outlander XT Right	07- 11	•	
800	Renegade Efi Left/Rear	07- 11		•
800	Renegade Efi Right	07- 11	•	
800	Renegade Left/Rear	08- 11		•
800	Renegade Right	08- 11	•	
800	Renegade X Left/Rear	08- 11	•	
800	Renegade X Right	08- 11	•	
1000	Commander MAX Right	14-		•
1000	Maverick Right	13-		•

**CANNONDALE**

440	Blaze Right	03	•	
440	Cannibal Right	03	•	
440	Glamis Right	03	•	
440	Moto Right	03	•	
440	Speed Right	03	•	

**JOHN DEERE**

500	Buck EX, EXT Left/Rear	05-		•
500	Buck EX, EXT Right	05-	•	
500	Buck Left/Rear	05-		•
500	Buck Right	05-	•	
500	Trail Buck Left/Rear	05-		•
500	Trail Buck Right	05-	•	
650	Trail Buck EX, EXT Left/Rear	05-		•
650	Trail Buck EX, EXT Right	05-	•	
650	Trail Buck Left/Rear	05-		•
650	Trail Buck Right	05-	•	



# Brake Pads

3112 ORGANIC

4112 SINTERED

5112 CERAMIC

A 55,2 | L 73,8 | S 8,0

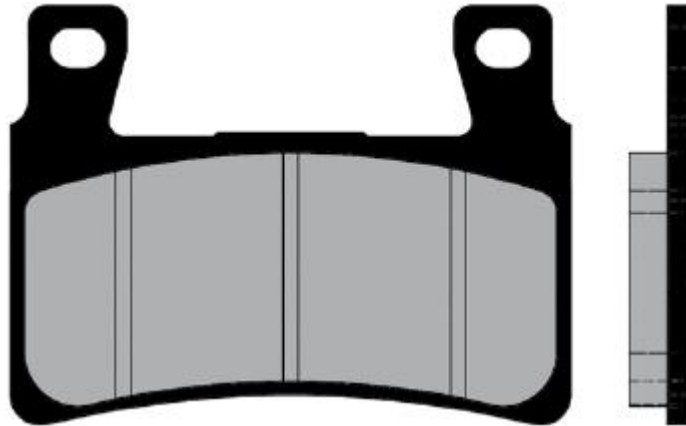

## HONDA

_CB	600	Hornet (Japan)	98- 99	•
_CBR	600	F4, F4 Sport	99- 06	•
_CBR	600	RR	03- 04	•
_CBR	900	RR Fireblade	98- 03	•
_VTR	1000	SP-1, SP-2	00- 06	•
_CB	1100	EX	14- 16	•
_CB	1100	EX	17-	•
_CB	1300		05-	•
_CB	1300	R	02- 04	•

## HYOSUNG

_GD	125	EXIV	12-	•
_GD	250	EXIV-R	15-	•
_GT	250	iR	15-	•
_GT	300	R	16-	•
_GV	300		16-	•
_GT	650	i	13-	•
_GT	650	i Naked	15-	•
_GT	650	iR	13-	•
_ST	700		11-	•
_ST	700	i Deluxe	13-	•

# Brake Pads

4113 SINTERED

5113 CERAMIC

A 42,0 | L 102,0 | S 8,0

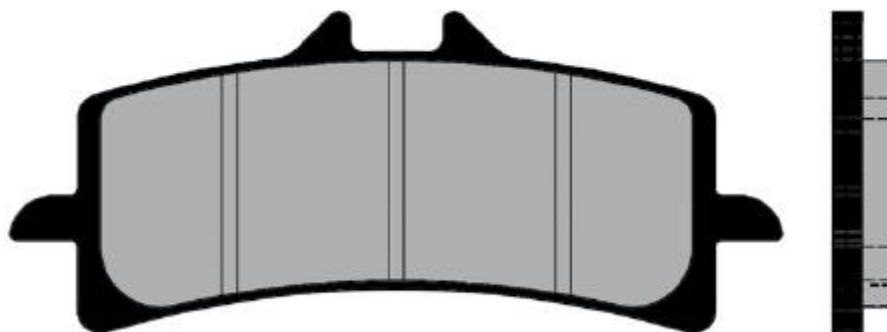

## APRILIA

RSV4	1000	ABS	09-	•
RSV4-R	1000	ABS APRC	10-	•
RSV4-RF	1000		15-	•
RSV4-RR	1000		15-	•

## BENELLI

TnT	1130	R	17-	•
-----	------	---	-----	---

## BIMOTA

3D	800	Tesi	16-	•
BB3	1000		14-	•
DB7	1099	(Rad.cal)	09-	•
DB8	1198	(Rad.cal)	10-	•
	1200	Impeto	16-	•
DB11	1200	VLX (Rad.cal)	13-	•

## BMW







S	1000	RRHP4	12- 14	•
	1200	HP2Sport	08- 10	•

## BREMBO RACING CALIPERS

		100 mm Radial Caliper 484, 220B47310, P4 32		
		100 mm Radial Monoblock 220988530, P4 34		
		108 mm Radial Caliper 484, 220B47310, P4 32		
		108 mm Radial Monoblock 220A39710, P4 34		
		Radial GP4 RX 220B01010		

## DUCATI

	848	EVO (Rad.cal)	11- 12	•
	848	Streetfighter S	12-	•
D16RR	990	Desmosedici RR	07- 08	•
	1098	(Rad. cal)	07- 08	•
	1098	R (Rad.cal)	08-	•
	1098	R Bayliss LE (Rad.cal)	09-	•
	1098	S (Rad. cal)	07- 08	•

					
1098	Streetfighter (Rad.cal)	09-	•		
1098	Streetfighter S (Rad.cal)	09-	•		
1100	Hypemotard	07-	•		
1100	Hypemotard EVOSP	10-	•		
1198	(Rad.cal)	09-	•		
1198	S (Rad.cal)	09-	•		
1198	SP (Rad.cal)	11-	•		
1199	Panigale	12- 14	•		
1199	Panigale R	13-	•		
1199	Panigale S	12- 14	•		
1199	Superleggera	14-	•		
1200	1200 Diavel	11-	•		
1200	1200 Diavel Strada	11-	•		
1200	Monster R	16-	•		
1200	Monster S	14- 16	•		
1200	Monster S	17-	•		
1200	Multistrada S	15-	•		
1200	Multistrada SD-air	15-	•		
1200	Multistrada S Pikes Peak	16-	•		
1200	Xdiavel	16-	•		
1200	Xdiavel S	16-	•		
1299	Panigale	15-	•		
1299	Panigale R	15-	•		
1299	Panigale S	15-	•		
1299	Panigale S Anniversario	17-	•		
1299	Superleggera	17-	•		
<b>HONDA</b>					
CBR	1000 RRSP	14- 16	•		
CBR	1000 RRSP	17-	•		
CBR	1000 RRSP2	17-	•		
RC213V-S	1000	16-	•		
<b>HOREX</b>					
VR6	1200 Cafe Racer	17-	•		
VR6	1200 Classic	17-	•		
<b>HUSQVARNA</b>					
FS	450	15-	•		
	900 Nuda RABS	12-	•		
<b>KAWASAKI</b>					
	1000 H2 Carbon Ninja	17-	•		
	1000 H2 Ninja	15-	•		
	1000 H2R Ninja	15-	•		
Z	1000 R	17-	•		
ZX-10R	1000 Ninja (Rad.cal)	16-	•		
ZX-10RR	1000 Ninja (Rad.cal)	17-	•		
ZZR	1400 Performance Sport	17-	•		
ZZR	1400 SE	16-	•		
<b>KTM</b>					
SX	450 SMR	13-	•		
	690 Duke R	14-	•		
	990 Supermoto R	10-	•		
RC8	1190	08-	•		
RC8	1190 R	09-	•		
RC8	1190 R Track	11-	•		
	1290 Super Duke GT	16-	•		
	1290 Super Duke R	14-	•		
<b>MV AGUSTA</b>					
	675 F3	15-	•		
	675 F3 RC	16-	•		
	800 F3	14-	•		



800	F3 RC	16-	•
1000	F4 R	12-	•
1000	F4 RC	15-	•
1000	F4 RR	12-	•
1078	Brutale RR	09	•
1078	F4 CC	08- 11	•
1078	F4 RR	08- 11	•
1090	Brutale Corse	14-	•
1090	Brutale RR	10-	•

**SUZUKI**

GSX-R	600 (Rad.cal)	11-	•
GSX-R	750 (Rad.cal)	11-	•
GSX-R	1000 (Rad.cal)	12- 15	•
GSX-R	1000 (Rad.cal)	16	•
GSX-R	1000 (Rad.cal)	17-	•
GSX-R	1000 R (Rad.cal)	17-	•
GSX-S	1000	15-	•
GSX-S	1000 F	15-	•
GSX-R	1300 Hayabusa (Rad.cal)	13-	•

**TRIUMPH**

675	Daytona R Triple (Rad.cal)	11-	•
1050	Speed 94R	15-	•
1050	Speed Triple	16-	•
1050	Speed Triple R	12- 15	•
1050	Speed Triple R	16-	•
1050	Speed Triple S	16-	•
1200	Thruxton R	16-	•

# 4114 SINTERED

## Brake Pads

A 42,1 | L 77,5 | S 9,0

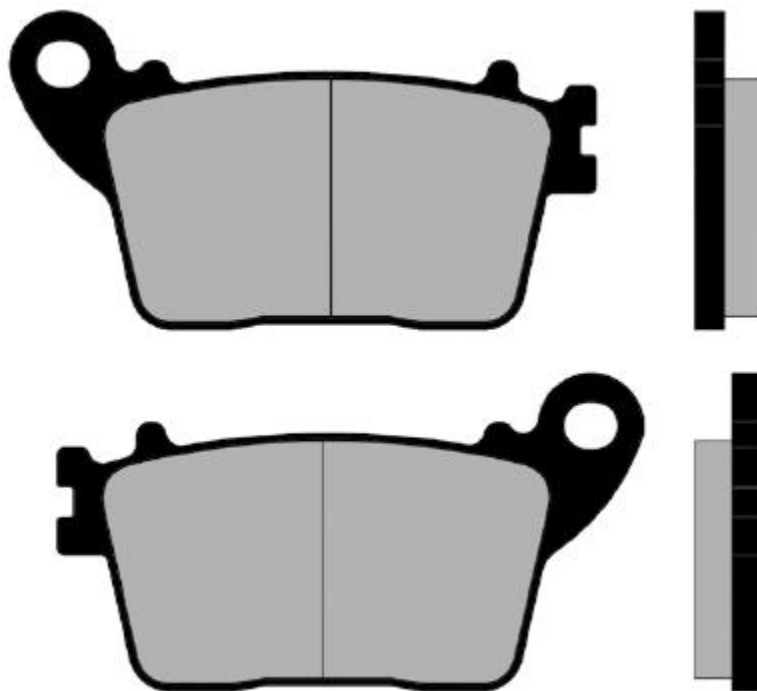

### HONDA

CB	600	Homet	07- 12	•
CBR	600	F	11-	•
CBR	600	RR (Rad.cal)	07-	•
CBR	600	RR (Rad.cal) ABS	09-	•
CBR	1000	RR Fireblade (Rad.cal)	06- 08	•
CBR	1000	RR fireblade (Rad.cal) ABS	09-	•
CBR	1000	RRSP	14- 16	•
CBR	1000	RRSP	17-	•
CBR	1000	RRSP2	17-	•

### KAWASAKI







ZX-6R	636	Ninja (Rad.cal)	13-	•
ZX-6R	636	Ninja (Rad.cal) ABS	13- 16	•
ZX-10R	1000	Ninja (Rad.cal)	11- 15	•
ZX-10R	1000	Ninja (Rad.cal)	16-	•
ZX-10R	1000	Ninja (Rad.cal) ABS	12- 15	•
ZX-10RR	1000	Ninja (Rad.cal)	17-	•

### SUZUKI

GSX-R	600	(Rad.cal)	11-	•
GSX-R	750	(Rad.cal)	11-	•
GSX-R	1000	(Rad.cal)	09- 15	•
GSX-R	1000	(Rad.cal)	16	•
GSX-R	1000	(Rad.cal)	17-	•
GSX-R	1000	R (Rad.cal)	17-	•

### YAMAHA

YZF	600	R6 (Rad.cal)	17-	•
-----	-----	--------------	-----	---

					
YZF	1000	R1 (Rad.cal)	15-		•
YZF	1000	R1M (Rad.cal)	15-		•
YZF	1000	R1S (Rad.cal)	16-		•



# Brake Pads

**4115** SINTERED  
**5115** CERAMIC

**A 50,0 | L 37,7 | S 7,5**  
 serie da 4 pz

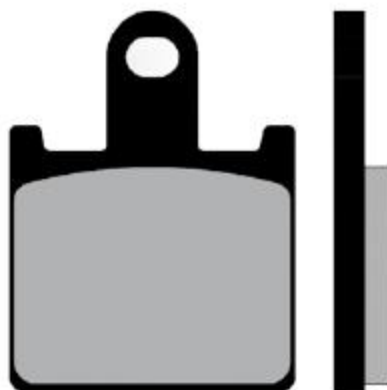

## KAWASAKI

ZX-6R	600	Ninja (Rad.cal)	07-	•
Z	750	R	11- 12	•
Z	1000		07- 09	•
GTR	1400	(Rad.cal)	07-	•
GTR	1400	(Rad.cal) ABS	07-	•
ZZR	1400	(Rad.cal)	06- 14	•
ZZR	1400	(Rad.cal) ABS	06- 14	•

## SUZUKI

	1300	B-King	07	•
--	------	--------	----	---



# Brake Pads

3117 ORGANIC  
 4117 SINTERED  
 5117 CERAMIC

A 50,3 | L 71,6 | S 7,5

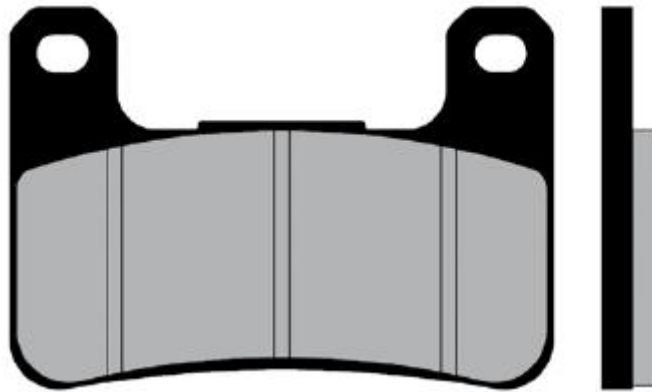

## KAWASAKI

Z	1000	(Rad.cal)	10-	•
Z	1000	(Rad.cal) ABS	15- 16	•
Z	1000	SE (Rad.cal)	14-	•
Z	1000	SX (Rad.cal)	11- 16	•
Z	1000	SX (Rad.cal)	17-	•
ZX-10R	1000	Ninja (Rad.cal)	08- 15	•
ZX-10R	1000	Ninja (Rad.cal) ABS	12- 15	•

## SUZUKI

GSX-R	600	(Rad.cal)	04- 10	•
GSX-R	750	(Rad.cal)	04- 10	•
DL	1000	V-Strom	14- 16	•
DL	1000	V-Strom	17-	•
DL	1000	V-Strom XT	17-	•
GSX-R	1000	(Rad.cal)	04- 11	•
GSX-R	1300	Hayabusa	08- 12	•
M	1800	R Intruder	06-	•
M	1800	R2 Intruder	08-	•
M	1800	RBZ Intruder	16-	•



# Brake Pads

4119 SINTERED

5119 CERAMIC

A 49,6 | L 38,7 | S 7,9  
serie da 4 pz

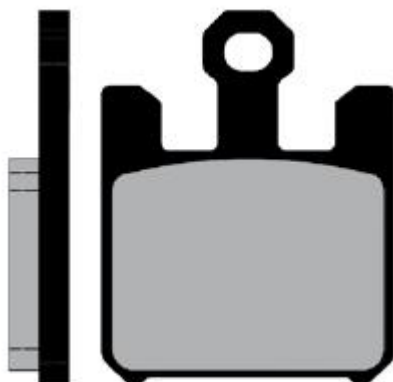

**DERBI**

659	Mulhacen	05	•
-----	----------	----	---

**KAWASAKI**

ZX-6RR	Ninja	Ninja (Rad.cal)	03- 06	•
ZX-6R	Ninja	Ninja (Rad.cal)	03- 06	•
ZX-10R	1000	Ninja (Rad.cal)	04- 07	•
ZX-12R	1200	Ninja (Rad.cal)	04- 06	•
VN	1600	MeanStreak	05-	•

**SUZUKI**

GSX-R	1000	(Rad.cal)	03	•
M	1600	Intruder	05-	•

# Brake Pads

4120 SINTERED  
5120 CERAMIC

A 49,5 | L 69,5 | S 7,0

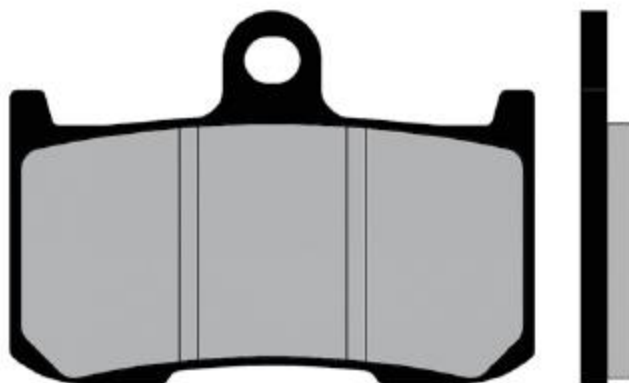

## INDIAN

	1800	Chief Classic	14-	•
	1800	Chief Vintage	14-	•
	1800	Chieftain	14-	•
	1800	DarkHorse	16-	•
	1800	Roadmaster	15-	•
	1800	Springfield	16-	•

## KAWASAKI

Z	800		13- 16	•
Z	800	ABS	13- 18	•
Z	800	eABS	13- 20	•
Z	900		17-	•
ZX-9R	900	Ninja	02- 03	•
Z	1000		03- 06	•

## MORIWAKI

MD	250		09-	•
----	-----	--	-----	---

## SUZUKI

GSX-S	750		17-	•
	1340	B-King	08-	•

## TRIUMPH

	675	Daytona (Rad.cal)	06- 08	•
	675	Street Triple R	09-	•
	675	Street Triple RX	15-	•
	1050	Street Triple (Rad.cal)	05- 07	•
	1050	Tiger	07-	•
	1050	Tiger SE (Rad.cal)	09-	•
	1050	Tiger Sport	15-	•

## VICTORY

	1634	Hammer	08	•
	1634	Kingpin all models	08-	•
	1634	Vegas	08-	•



1634	Vegas 8-Ball	08-	•
1634	Vegas Jackpot	08	•
1731	Boardwalk	13-	•
1731	Cross Country	10-	•
1731	Cross C8-Ball	14-	•
1731	Cross Country Tour	12-	•
1731	Cross Roads	10-	•
1731	Cross Roads 8-Ball	14-	•
1731	Cross Roads Classic	14-	•
1731	Gunner	15-	•
1731	Hammer	09-	•
1731	Hammer 8-Ball	10-	•
1731	HammerS	09-	•
1731	Hard-Ball	12-	•
1731	High-Ball	12-	•
1731	Jackpot	10-	•
1731	Judge	13-	•
1731	Kingpin	10-	•
1731	Kingpin 8-Ball	10-	•
1731	Magnum	15-	•
1731	Magnum X-1	15-	•
1731	Vegas	10-	•
1731	Vegas 8-Ball	10-	•
1731	Vegas Jackpot	09-	•

# Brake Pads

4122 SINTERED

5122 CERAMIC

A 40,5 | L 34,9 | S 9,0

serie da 4 pz

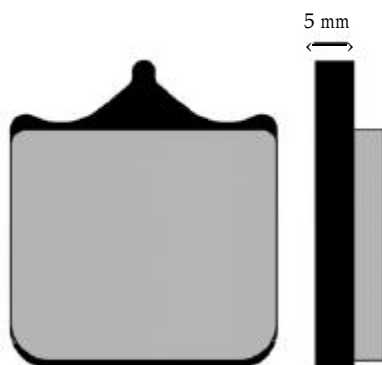

## BMW

S	1000	R	13-	•
S	1000	RR	09-	•



# 4123 SINTERED

## Brake Pads

A 51,5 | L 77,3 | S 8,6

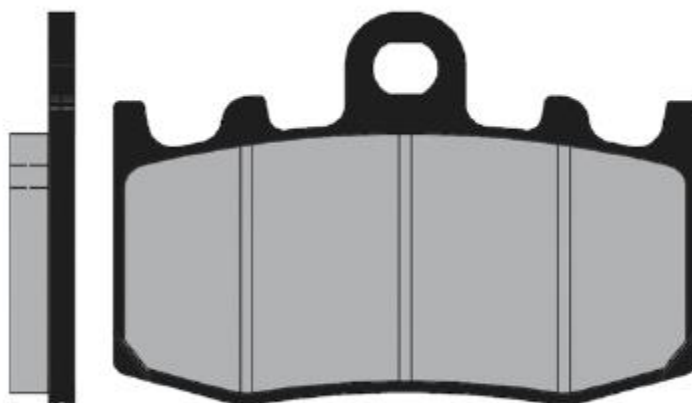

### BMW

R	850	RT With Integral ABS	01- 06	•
R	1100	S Without Integral ABS	01- 05	•
R	1150	GS,GS Adventurer	02- 05	•
R	1150	RT With Integral ABS	01- 06	•
	1200	HP2 Megamoto	06- 08	•
K	1200	GT (K41) with Integral ABS	02- 05	•
K	1200	GT (K41) with Integral ABS	04- 08	•
K	1200	RS	01- 05	•
K	1200	S	05- 08	•
R	1200	GS	04- 12	•
R	1200	GS Tripple Black	11-	•
R	1200	RT	06- 13	•
R	1200	S	06- 07	•
R	1200	ST	06- 07	•
K	1300	GT	09- 10	•
K	1300	S	09-	•

# 4124 SINTERED

## Brake Pads

A 46,0 | L 81,3 | S 9,0

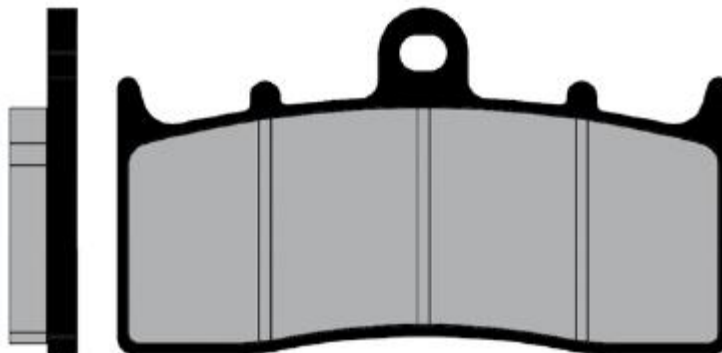

### BMW

R	850	R	03- 07	•
R	1100	S With Integral ABS	01- 05	•
R	1150	R	01- 06	•
R	1150	R Rockster	03- 05	•
R	1150	RS	01- 04	•
K	1200	LT With Integral ABS	01- 08	•
K	1200	R	05- 08	•
K	1200	R Sport	05- 07	•
R	1200	C Classic	03- 04	•
R	1200	C Independent	03- 04	•
R	1200	C Montauk	02- 04	•
R	1200	CL	03- 04	•
R	1200	R	07- 14	•
K	1300	R	09-	•
K	1300	R Dynamic	11-	•
K	1600	B	17-	•
K	1600	GT	11-	•
K	1600	GTL	11-	•



# Brake Pads

3127 ORGANIC  
4127 SINTERED

A 55,0 | L 69,8 | S 8,5

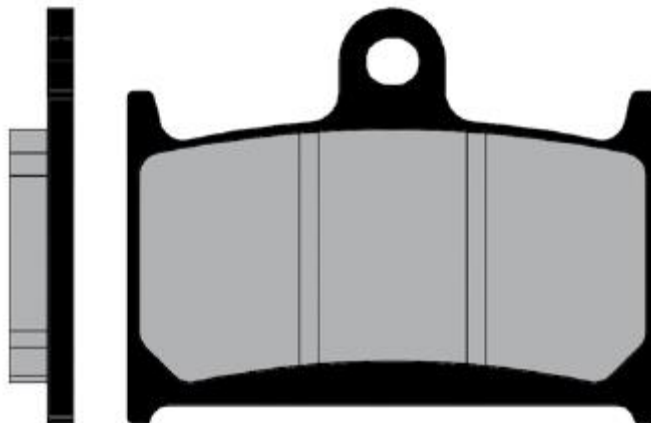

## MZ

1000	(MUZ)S	03-	•
1000	(MUZ)SF	05-	•
1000	(MUZ)SFX	07-	•
1000	(MUZ)SN	05-	•
1000	(MUZ)ST	07-	•

## NISSIN

4 Piston Caliper

## SUZUKI

RGV	250		88	•
GSX-R	400	R	90- 95	•
GSX-R	600		92- 93	•
GSX-R	750		88- 93	•
RF	900	RR,RS,RS2,T,V	94- 97	•
GSX	1100	Katana	93-	•
GSX-R	1100		89- 92	•
GSF	1200	Bandit	95- 96	•
GSF	1200	Bandit	97- 00	•

## TRIUMPH

	600	Daytona	03- 04	•
	600	Speed Four	03- 06	•
TT	600		00- 03	•
	650	Daytona	05- 06	•
	750	Daytona	91- 92	•
	900	Daytona	91- 94	•
	900	Daytona Srpint	94-	•



	900	Speed Triple	94- 96	•
	900	Trophy	96-	•
T509	900	Speed Triple	97- 01	•
T595	950	Daytona	96- 98	•
	955	Daytona Centennial	02-	•
	955	Daytona from VIN 132513	99-	•
	955	Daytona to VIN 132512	99-	•
	955	Speed Triple	99-	•
	955	Sprint RS	00-	•
	955	Sprint ST	99- 04	•
	1000	Daytona	92	•
	1050	Sprint GT ABS	11-	•
	1050	Sprint ST	05- 11	•
	1200	Daytona	91-	•
	1200	Tiger Explorer	12-	•
	1200	Trophy	96- 03	•
	1600	Thunderbird	09-	•
	1700	Thunderbird Commander	14-	•
	1700	Thunderbird LT	14-	•
	1700	Thunderbird Storm	11-	•
	2300	Rocket III	04-	•
	2300	Rocket III Classic	07-	•
	2300	Rocket III Roadster	10-	•
	2300	Rocket III Touring	13-	•
	2300	Rocket X	15-	•

**YAMAHA**

TZ	125		97-	•
TZ	250	(Rad.cal)	02-	•
TZ	250		90- 01	•
FZR	750	R	89- 92	•

# Brake Pads

4128 SINTERED

5128 CERAMIC

A 48,8 | L 43,2 | S 9,5

serie da 4 pz

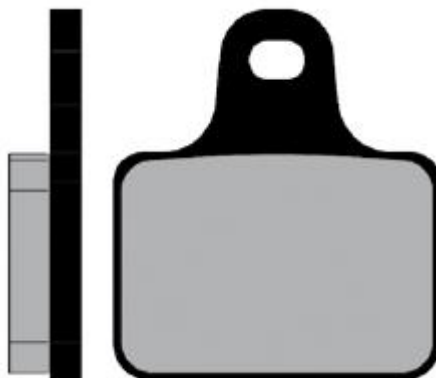

## A.P. RACING CALIPERS

CP-6688 Four Pad Radial

4 Piston Monoblock

## ACCOSSATO

AGPZ01, 108 mm CNC Monoblock, 4 Piston/4 Pad

AGPZ02, 108 mm Forged Monoblock, 4 Piston/4 Pad

AGPZ03, 108 mm Forged Monoblock, 4 Piston/4 Pad

AGPZ04, 108 mm Forged Monoblock, 4 Piston/4 Pad

AGPZ06, 60 mm CNC Moto 3, 2 Piston/2 Pad

## PVM

4 Pad Caliper

## BREMBO RACING CALIPERS

Moto3/SBK XA88810/11, P2 34

Moto3/SBK XA88820/21, P2 34

Radial Monoblock X99C460/61, P4 34



# 3130 ORGANIC

Brake Pads

A 41,6 | L 109,5 | S 8,0  
A 44,6 | L 111,2 | S 8,0

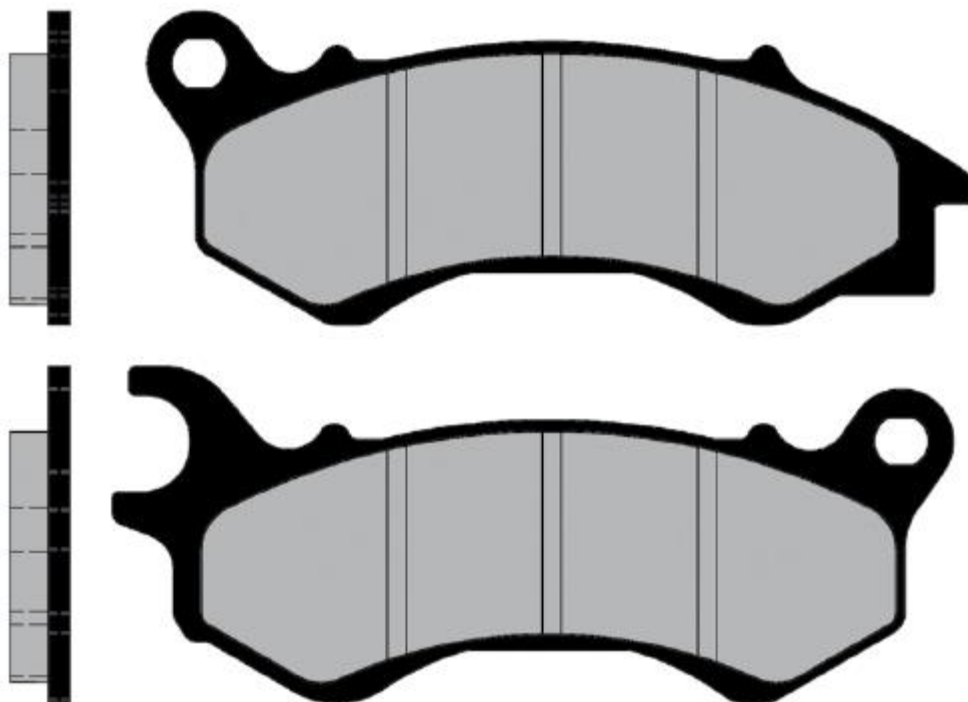

## HONDA

NSC	50	Vision	10-	•
NSC	110	Vision	10- 12	•
SCV	110	Lead	10- 12	•
PCX	125		09-	•
PCX	150		12-	•

## PEUGEOT

	50	Django Allure	14-	•
	50	Django Evasion	14-	•
	50	Django Sport	14-	•
	125	Django Allure	14-	•
	125	Django Evasion	14-	•
	125	Django Sport	14-	•
	125	Satelis Black Ed.	17-	•
	150	Django Allure	14-	•
	150	Django Evasion	14-	•
	150	Django Sport	14-	•





# 3132 ORGANIC

## Brake Pads

A 43,0 | L 41,0 | S 7,7

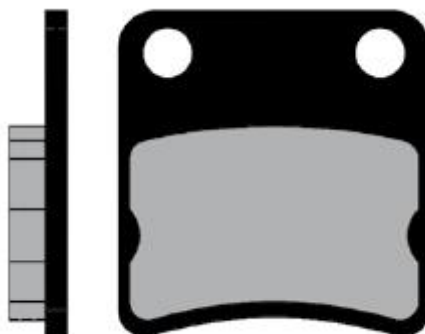

### BS VILLA

ZX	50		93-	•
----	----	--	-----	---

### CAGIVA

	50	City	92- 94	•
--	----	------	--------	---

### DAELIM

	50	Bonita	09-	•
--	----	--------	-----	---

GZ	50	GMessage	98-	•
----	----	----------	-----	---

SI	50	S-Five	06- 12	•
----	----	--------	--------	---

### GARELLI

	125	Panther	02-	•
--	-----	---------	-----	---

	150	Panther	02-	•
--	-----	---------	-----	---

	250	Panther	02-	•
--	-----	---------	-----	---

### HONDA

	50	Giorno	92- 94	•
--	----	--------	--------	---

	50	Jazz	92-	•
--	----	------	-----	---

	50	Tact S	93-	•
--	----	--------	-----	---

CRM	50		93- 96	•
-----	----	--	--------	---

GP	50	Dio	89- 90	•
----	----	-----	--------	---

GP	50	Dio	91-	•
----	----	-----	-----	---

HSC	50	ZR, 01 Scooter	92-	•
-----	----	----------------	-----	---

SC	50	1-ZX	92-	•
----	----	------	-----	---

SP	50		92-	•
----	----	--	-----	---

SR	50	Dio	93-	•
----	----	-----	-----	---

SR	50	Super Dio	91- 92	•
----	----	-----------	--------	---

ZX	50	Super Dio	92-	•
----	----	-----------	-----	---

### SYM

	50	Super Fancy	98-	•
--	----	-------------	-----	---

# Brake Pads

**3133 ORGANIC**  
**4133 SINTERED**

A 47,0 | L 93,9 | S 8,6  
 A 47,0 | L 72,3 | S 10,9

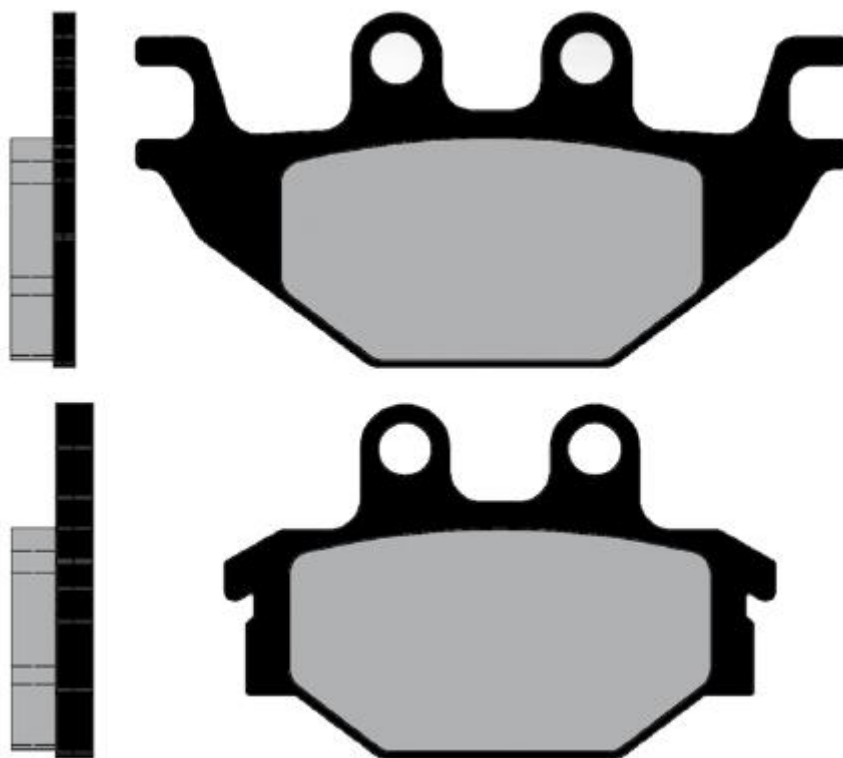

## ADLY

	300	Cross XOver	07-	•
	300	Cross XRoad	07-	•
ATV	300	Sport	07-	•
	320	S	07-	•
	320	U	07-	•

## ARCTIC CAT

	250	DVX	06- 09	•
	300	DVX	09-	•

## CAN-AM

DS	250		08-	•	•
----	-----	--	-----	---	---

## CECTEK

	500	EFI Gladiator	09-	•
--	-----	---------------	-----	---

## CFI

	250	XS ATV	07-	•
--	-----	--------	-----	---

## HERCULES

	280	ATV	07-	•
	300	ATV Sport	07-	•

## INDIAN

	1000	Scout Sixty	16	•
	1130	Scout	15- 16	•

## KAWASAKI

KVF	300	Brute Force	13-	•
-----	-----	-------------	-----	---



**KYMCO**

	250	MXU	06-	•	
	250	Urban Quad	06-	•	
<b>KXR</b>	250		04-	•	
	300	Maxxer	06-	•	
	300	Maxxer Supermoto	15-	•	
	300	MXU	06-	•	•
	500	MXU	06- 08	•	•
	500	UXV 4x4	08-	•	•

**PGO**

	500	Bug	08-		•
<b>BR</b>	500	i Racer	07-		•

**SYM**

<b>SB</b>	125	Wolf Ni	11-		•
	200	Quadlander	12-	•	
	200	Trackrunner	05- 08	•	
	250	Quadlander	06- 07	•	
<b>SN</b>	250	Ni Wolf	14-		•
	300	City Max	06- 07	•	
	300	Quadlander	06-	•	•
	300	Wolf Cafe Racer	15-		•
	300	Wolf Classic	15-		•
<b>SB</b>	300	Cafe Racer	16-		•
	600	Quad Raider	08-	•	•

**YAMAHA**

<b>MT</b>	125		14-		•
<b>YZF</b>	125	R	08-		•



# 4135 SINTERED

Brake Pads

A 55,0 | L 75,0 | S 10,8



**YAMAHA**

FZR	250		87- 88	•
TDR	250		88- 92	•
TZR	250		87- 88	•
FZR	400		88- 90	•
SRX	400		87-	•
SRX	600		88- 89	•
FZ	750	Genesis	89- 92	•
TDM	850		91- 95	•
XVZ	1300	A Royal Star	96- 07	•
XVZ	1300	AT Royal Star Tour Classic	97- 07	•
XVZ	1300	Royal Star Boulevard	99-	•
XVZ	1300	TF Royal Star Venture	99-	•
XVZ	1300	Venture Royale	86- 89	•
XVZ	1300	Venture Royale	90- 95	•
XV	1600	A Wild Star	99- 07	•
XV	1700	Road Star Warrior	02	•

# 4136 SINTERED

Brake Pads

A 52,5 | L 70,0 | S 8,0

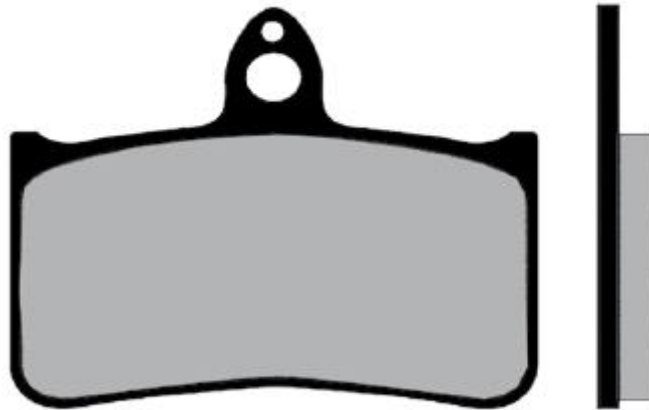

## HONDA

NS	125		89	•
NS	250		89	•
NSR	250	R, SP	90	•
NSR	250	RJ	88-	•
RS	250	R	91- 92	•
NTV	400	Bros II	88	•
RVF	400	RR (NC35)	90- 96	•
VFR	400	R	89- 92	•
VIR	400	R (NC 30)	90	•
NTV	600	Bros I	88-	•
NTV	650	Bros	88- 97	•
NR	750		92-	•
RVF	750	RR (RC-45)	94- 98	•
VFR	750	R	88- 93	•
CB	900	Hornet	02- 07	•
CBR	900	RR Fireblade	92- 97	•
CB	1000	F (Big One)	93- 97	•
VIR	1000	F Firestorm	97- 07	•
CB	1300	X-4	97- 03	•

# Brake Pads

3137 ORGANIC  
4137 SINTERED

A 57,5 | L 60,0 | S 8,0

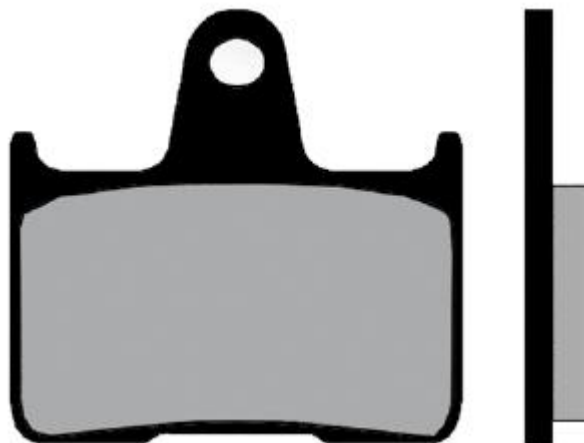

## HARLEY DAVIDSON

XL	883	L Super Low	14-	•
XL	883	N Iron	14-	•
XL	883	R Roadster	14-	•
XL	1200	C, CA, CB, CP Custom	14-	•
XL	1200	CX	17-	•
XL	1200	T Super Low	15-	•
XL	1200	V Seventy-two	14-	•
XL	1200	X Forty-Eight	14-	•

## HONDA

VT	750	CS ABS	13-	•
VT	750	CS ABS	13-	•
CB	1300	R	02- 04	•
CB	1300	SF	98- 00	•
CB	1300	X-4	97- 03	•

## KAWASAKI

ZX-7RR	750	Ninja	96- 02	•
GIR	1400	(Rad.cal)	07-	•
GIR	1400	(Rad.cal) ABS	07-	•
ZZR	1400	(Rad.cal)	06- 14	•
ZZR	1400	(Rad.cal) ABS	06- 14	•
ZZR	1400	Performance Sport	17-	•
ZZR	1400	SE	16-	•

## MZ

	1000	(MUZ)S	03-	•
	1000	(MUZ)SF	05-	•
	1000	(MUZ)SFX	07-	•
	1000	(MUZ)SN	05-	•
	1000	(MUZ)SI	07-	•

## SUZUKI

GSX-R	600	(Rad.cal)	04- 05	•
-------	-----	-----------	--------	---





GSF	650	Bandit / S Bandit Left/Rear	05	•
GSX-R	750	(Rad.cal)	04- 05	•
GSX-R	1000	(Rad.cal)	03- 06	•
GSX-R	1000		01- 02	•
GSX	1400		02- 07	•

# 4138 SINTERED

## Brake Pads

A 55,0 | L 75,0 | S 8,8

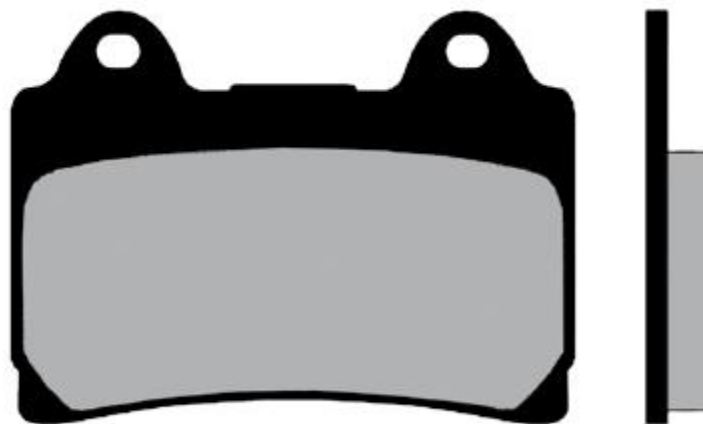

### YAMAHA

FZR	400	A	90	•
SRX	400		85- 86	•
SRX	600		90-	•
FZR	750	R Genesis	87- 88	•
TRX	850		95- 00	•
FZR	1000	Genesis	87- 89	•
FJ	1200		88- 90	•
FJ	1200	ABS	91- 93	•
XJR	1200		94- 98	•
XJR	1200	SP	97- 98	•
XVZ	1300	A Royal Star	96- 07	•
XVZ	1300	AT Royal Star Tour Classic	97- 07	•
XVZ	1300	Royal Star Boulevard	99-	•
XVZ	1300	Venture Royale	86- 89	•
XVZ	1300	Venture Royale	90- 95	•

# Brake Pads

3139 ORGANIC  
4139 SINTERED

A 39,0 | L 100,0 | S 9,5

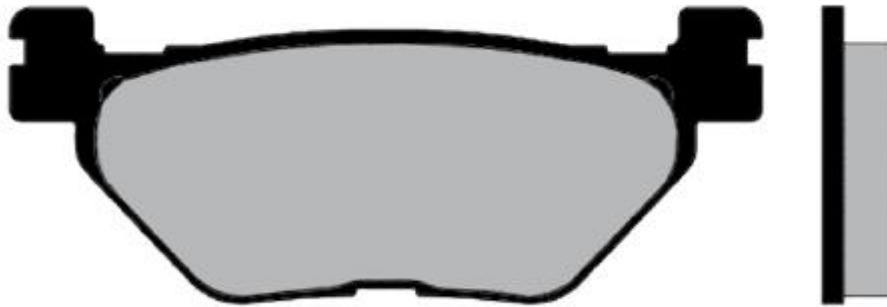

## HYOSUNG

GV	650	Aguila	04- 05	•
<b>YAMAHA</b>				
TDM	900		02- 14	•
SCR	950	Scrambler	17-	•
XV	950	Bolt	14-	•
XV	950	Bolt C-Spec	15-	•
XV	950	Bolt R-Spec	14-	•
XVS	950	A Midnight Star	09-	•
XTZ	1200	Super Tenere	10-	•
XTZ	1200	Super Tenere ZE	14-	•
FJR	1300		01- 03	•
FJR	1300	A	13- 15	•
FJR	1300	A	16-	•
FJR	1300	ABS	03- 12	•
FJR	1300	AE	16-	•
FJR	1300	AS	13- 15	•
FJR	1300	AS	16-	•
XVS	1300	A Midnight Star	07- 11	•
XVS	1300	Custom	14-	•
XVS	1300	Stryker	11-	•
VMX	1700	V-Max	09-	•
XV	1700	PC Road Star Warrior	03- 07	•
XV	1900	A	11-	•
XV	1900	A Midnight Star	06- 10	•



# Brake Pads

3141 ORGANIC  
4141 SINTERED

A 53,6 | L 55,6 | S 9,0

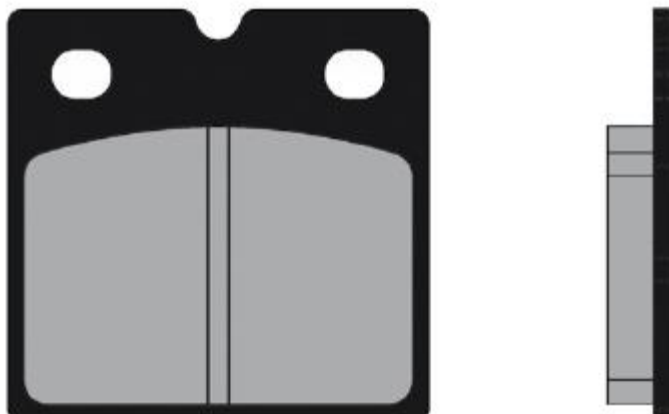

## APRILIA

AF1	250	Replica	90-		•
-----	-----	---------	-----	--	---

## BENELLI

	350	4T Turismo			•
	354		78- 82		•
	500	4T	- 76		•
	750	Sei	75-	•	
	900	Sei	84-	•	•

## BERINGER

2 Piston Classic Billet Caliper

## BIMOTA

		all models	82- 88	•	•
SB3		D	83-	•	•
BMW					
R65	650	GS	87- 92	•	
R65	650	GS	91- 92	•	
R65	650	LS	82- 85	•	
R65/1	650		86-		•
K75	750		90	•	•
K75	750	C	85- 88	•	
K75	750	RT	91-	•	•
K75	750	S, C	85- 95	•	•
R80	800		85	•	
R80	800	G/SP-D.	86	•	
R80	800	GS	81- 87	•	
R80	800	GS	91- 92	•	
R80	800	R	91-		•
R80	800	R	93-	•	
R80	800	RT	83	•	
R80/7	800		79- 81		•
K1	1000		89		•



K100	1000	LT	87	•	•
K100	1000	LT	92-		•
K100	1000	LT ABS	89	•	•
K100	1000	RS	90-		•
K100	1000	RS ABS	88- 89	•	•
K100	1000	RS, RT	83- 89	•	•
R100	1000		81- 84	•	•
R100	1000	CS, RS, RT	81- 84	•	•
R100	1000	R	91-		•
R100	1000	RS	76- 80		•
R100	1000	RS	93-	•	•
R100	1000	S	78- 80		•
R100	1000	T	79-		•
K1100	1100	LT/SE	92-		•
K1100	1100	RS	93-		•
R1100	1100	RS	93- 94		•
K	1200	GT (K41) With Integral ABS	02- 05		•
K	1200	RS	97- 05		•

**BREMBO RACING CALIPERS**

108N, P2 38, F08

CZ					
CZ	180		93-	•	

**DUCATI**

	250	Desmo	- 77	•	
	350	Desmo	- 77	•	
	350	F3	86-	•	•
	500	Sport	77-	•	•
	600	Pantah TL, SL		•	•
	600	SL, TL Pantah	76-	•	
	650	Pantah	84-	•	•
	750	F1	86-	•	•
	750	GT	74- 76	•	
	750	Paso	87	•	
	750	Sport	90	•	•
	750	SS	74-	•	•
	750	SS	91-		•
	851	Strada	91-		•
	860	GT		•	•
	860	GT	75- 77	•	
	888	Roche Replica	91-		•
	900	GTS	77-	•	
	900	Mike Halwood Replica	85-	•	•
	900	S2 Desmo	85-	•	•
	900	Sport	77-	•	•
	900	SS	78- 89	•	•
906	900	Paso	89	•	
	1000	6 Mike Halwood Replica	85-	•	•
	1000	Mille Replica	84-	•	•
	1000	S2 Desmo	85-	•	•







**HERCULES**

Silver Star Classic 93 •

**HOREX**

	80	Rebell T	86-	•	•
	80	Sport L	86-	•	•
	125	Imperator	96-	•	
	125	Regent	96-	•	
	560	E	86-	•	•
	600	Columbus	87-	•	•

**INDIAN**

					
1700	Chief Blackhawk		11- 13		•
1700	Chief Bomber		10- 13		•
1700	Chief Classic		10- 13		•
1700	Chief Dark Horse		10- 13		•
1700	Chief Deluxe		09- 13		•
1700	Chief Roadmaster		09- 13		•
1700	Chief Standard		09- 13		•
1700	Chief Vintage		09- 13		•
<b>JAWA</b>					
CZ	125	2T			•
CZ	125	MX			•
CZ	180		92		•
	300	Trail	93-		•
<b>LAVERDA</b>					
SFC	500				•
SFC	600		86-		•
	650	V-Six	93-		•
SF2	750		74- 78		•
SF3	750		74- 78		•
SF3	750	RGS Corsa, Executive	77-		•
	1000	Jota	76-		•
3C	1000	3CE, 3CL	74-		•
RGS	1000		83-		•
RGS	1000	Jota	86-		•
SFC	1000		85- 86		•
TGA	1000	Executive	84-		•
	1200	Mirage	78-		•
<b>MOTO-GUZZI</b>					
NIX	350		90-		•
V35	350	C			•
V35	350	Florida			•
V35	350	GT	90-		•
V35	350	III	87-		•
V35	350	TT	86-		•
NIX	650		90-		•
V65	650	Florida	86-		•
V65	650	GT	90-		•
NIX	750		90-		•
S3	750	Left	75- 76		•
S3	750	Right	75- 76		•
SP	750		91-		•
V75	750		86-		•
V75	750	Duna	86-		•
V75	750	TT Paris-Dakar	86-		•
	850	Le Mans	76-		•
T	850		74- 76		•
T3	850		75-		•
T4	850		75-		•
T5	850		75-		•
T5	850	N.T.	86-		•
	1000	California II	85- 88		•
	1000	California III C	91- 95		•
	1000	California III, Fuel Injection	89		•
	1000	Daytona	91-		•
	1000	Le Mans IV	85-		•
	1000	Le Mans, V	90-		•
GT	1000	V	91-		•
S	1000		90		•
SP	1000	III	91-		•



SP	1000	Le Mans Left/Rear	79-	•	
SP	1000	Le Mans Right	79-	•	
V	1000	Strada	93-	•	
	1100	California	96-	•	•
<b>MV AGUSTA</b>					
		all models		•	•
<b>MZ</b>					
	125	Roadstar		•	
	125	Sportstar	93-	•	
EIZ	125		82-	•	
EIZ	150		82-	•	
EIZ	250		82-	•	
	251	(MUZ) Sportstar	96-	•	
	251	Saxon Tour		•	
EIZ	251		89	•	
EIZ	300	LUX	90	•	
EIZ	300	X	88	•	
	301	(MUZ) Sportstar	96-	•	
	301	Saxon Tour		•	
EIZ	301		90-	•	
	500	Saxon Country	92-	•	
	500	Saxon Fun	92-	•	
	500	Saxon Voyager		•	
	500	Silver Star Classic	93-	•	
<b>NORTON</b>					
		Commander	90	•	•
		Interpol	83-	•	•
		Wankel Classic	88-	•	•
F-1			90		•
<b>OSSA</b>					
	500	Yanqee	78	•	
<b>SWM</b>					
XP	350	Sahara		•	
<b>TRIUMPH</b>					
	750	Bonneville UK	87-	•	•
<b>ZUNDAPP</b>					
KS	175		78-	•	



# Brake Pads

3142 ORGANIC  
4142 SINTERED

A 51,9 | L 69,7 | S 7,5

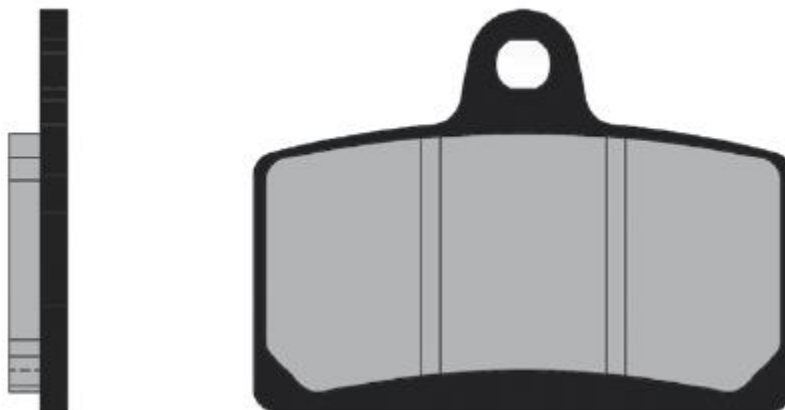

## APRILIA

RS-4	50		12-	•
RS-4	50	Replica	16-	•
	125	Tuono ABS	17-	•
RS-4	125	(AJP cal.)	11-	•
RS-4	125	Replica, ABS	16-	•

## BLATA

	125	Enduro	07-	•
	125	Motard	07-	•

## DERBI

	50	DRD Pro corse	06-	•
GPX1	50		06-	•
GPR	80	Cup	04-	•
GPR	125		05-	•
GPR	125	Nude	05-	•
GPR	125	Racing	09-	•

## GILERA

SC	125		06-	•
----	-----	--	-----	---

## MALAGUTI

NKD	50	Dragon	06-	•
-----	----	--------	-----	---

## MOTORHISPANIA

RX	50	R	08-	•
MH7	125	Naked	08-	•
RX	125		08-	•

## PEUGEOT

XR7	50		08-	•
-----	----	--	-----	---

## RIEJU

RS3	50	Pro	12-	•
	125	Tango	06-	•
RS3	125		10-	•

## TOMOS

SM	125	F (Rad.cal)	06-	•
----	-----	-------------	-----	---

# Brake Pads

3143 ORGANIC  
4143 SINTERED

A 46,2 | L 88,0 | S 8,3

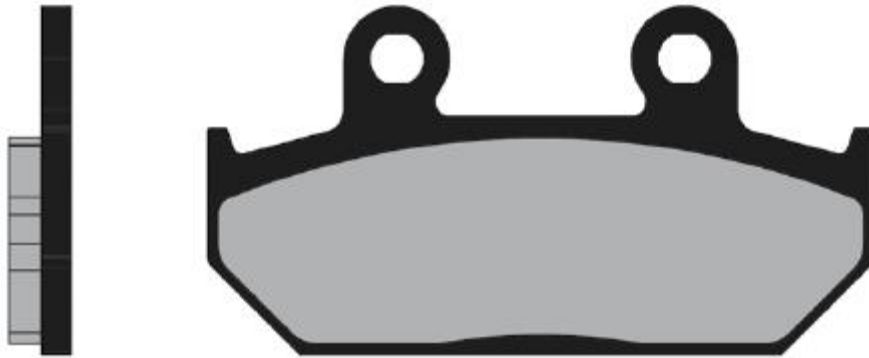

## CAGIVA

	500	Canyon	99-	•
	750	Elefant	93- 95	•
	900	Canyon I.E.	97-	•
	900	Elefant I.E.	91- 92	•

## HONDA

CB	125	TT	90	•
CB	250		88-	•
CD	250	UJ	88- 92	•
NV	400	Steed	88	•
NX	500	Dominator (Austria)	88- 92	•
NX	500	Dominator (Austria)	93- 96	•
NV	600	C	88-	•
VT	600	C,Shadow	88- 93	•
	600	Steed	88- 91	•
NX	650	Dominator J-K	88- 92	•
NX	650	Dominator	93- 96	•
XRV	650	Africa Twin	88- 89	•
VFR	700	F, F2	86- 87	•
CBR	750	Hurricane	87-	•
VFR	750	F	86- 87	•
CBR	1000	F	87- 88	•
GL	1500	A, SE, I Gold Wing	94-	•
GL	1500	Gold Wing, Gold Wing SE	88-	•
GLX	1500		88-	•



# Brake Pads

4145 SINTERED  
5145 CERAMIC

A 50,8 | L 85,0 | S 8,0

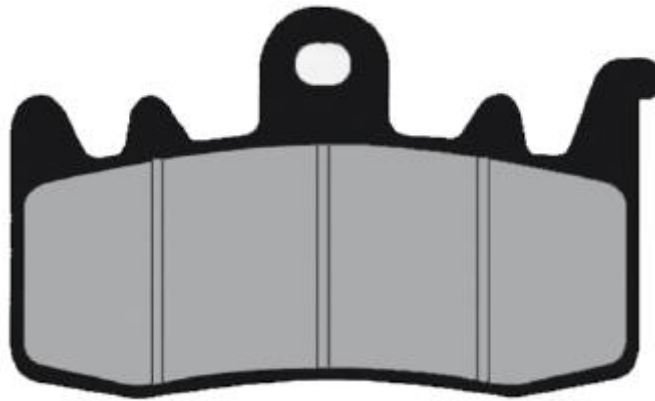

## APRILIA

RSV	1000	Tuono V4R	14-	•
RSV	1100	Tuono V4	15-	•
RSV	1100	Tuono V4 Factory	16-	•
RSV	1100	Tuono V4 RR	15-	•
	1200	Caponord	13-	•
	1200	Caponord Rally	15-	•

## BMW

F	800	R	15-	•
S	1000	XR	15-	•
R	1200	GS	13-	•
R	1200	GS Adventure	14-	•
R	1200	Nine-T	14-	•
R	1200	R	15-	•
R	1200	RS	15-	•
R	1200	RT	14-	•

## DUCATI

	797	Monster	17-	•
	800	Hypermotard	13- 15	•
	800	Hypermotard ABS	13- 15	•
	800	Hypermotard SP	13- 15	•
	800	Hypermotard SP ABS	13- 15	•
	800	Hyperstrada	13- 15	•
	800	Hyperstrada ABS	13- 15	•
	800	Scrambler Classic	15-	•
	800	Scrambler Emdirp	15-	•
	800	Scrambler Track Pro	16-	•
	800	Scrambler Full Throttle	15-	•
	800	Scrambler Icon	15-	•
	800	Scrambler Urban Enduro	16-	•
	800	Scrambler-X Desert Sled	17-	•
	821	Monster	15-	•



821	Monster Dark	15-	•
899	Panigale	14- 15	•
939	Hypermotard	16-	•
939	HypermotardSP	16-	•
939	Hyperstrada	16-	•
939	SuperSport	17-	•
939	SuperSport S	17-	•
950	Multistrada	17-	•
959	Panigale	16-	•
1200	Monster	14- 16	•
1200	Monster	17-	•
1200	Multistrada	15-	•
1200	Multistrada Enduro	16-	•
<b>FANTIC</b>			
500	Caballero	17-	•
<b>KYMCO</b>			
AK	550	17-	•
<b>MV AGUSTA</b>			
800	Rivale	13-	•
800	Stradale	15-	•
800	Turismo Veloce	14-	•
800	Turismo Veloce Lusso	14-	•
800	Turismo Veloce RC	17-	•

# Brake Pads

3146 ORGANIC  
4146 SINTERED

A 44,4 | L 105,9 | S 9,7  
A 41,2 | L 113,6 | S 8,8

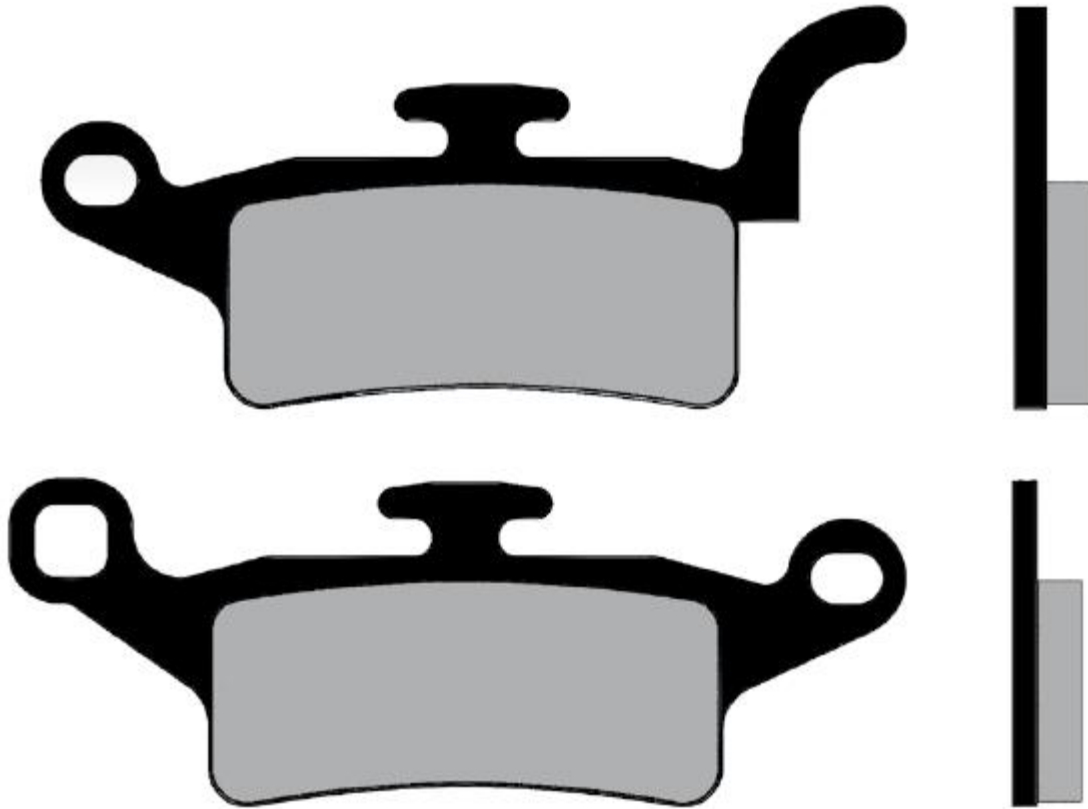

**MBK**

YW	125	Z	10-	•
----	-----	---	-----	---

**YAMAHA**

	125	Xenter	12-	•
BWs	125		10-	•
YW	125	Z	10-	•
	150	Xenter	12-	•

# Brake Pads

3147 ORGANIC

4147 SINTERED

A 36,5 | L 111,5 | S 7,6  
A 33,5 | L 99,0 | S 7,6

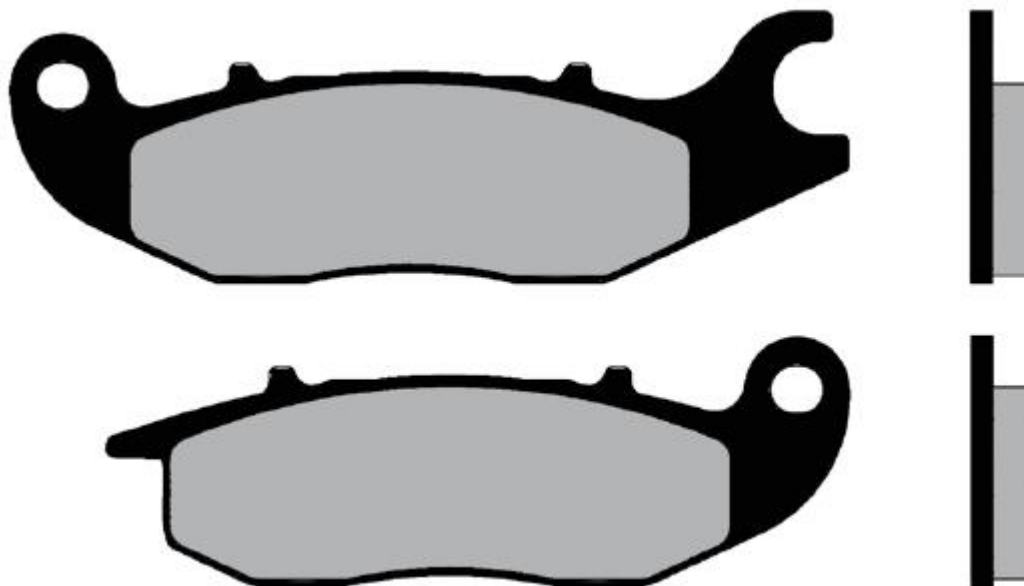

## HONDA

ANF	125	i Innova	07- 11	•
ANF	125	Innova	03- 06	•
CBF	125		09-	•
CBR	125	R	03- 14	•
MSX	125		14-	•
CBR	150	R	00-	•

## RIEJU

RS2	50	NKD	06-	•
RS2	125	NKD	06-	•

# Brake Pads

3148 ORGANIC

4148 SINTERED

A 46,2 | L 88,0 | S 10,0

A 46,2 | L 104,0 | S 10,0

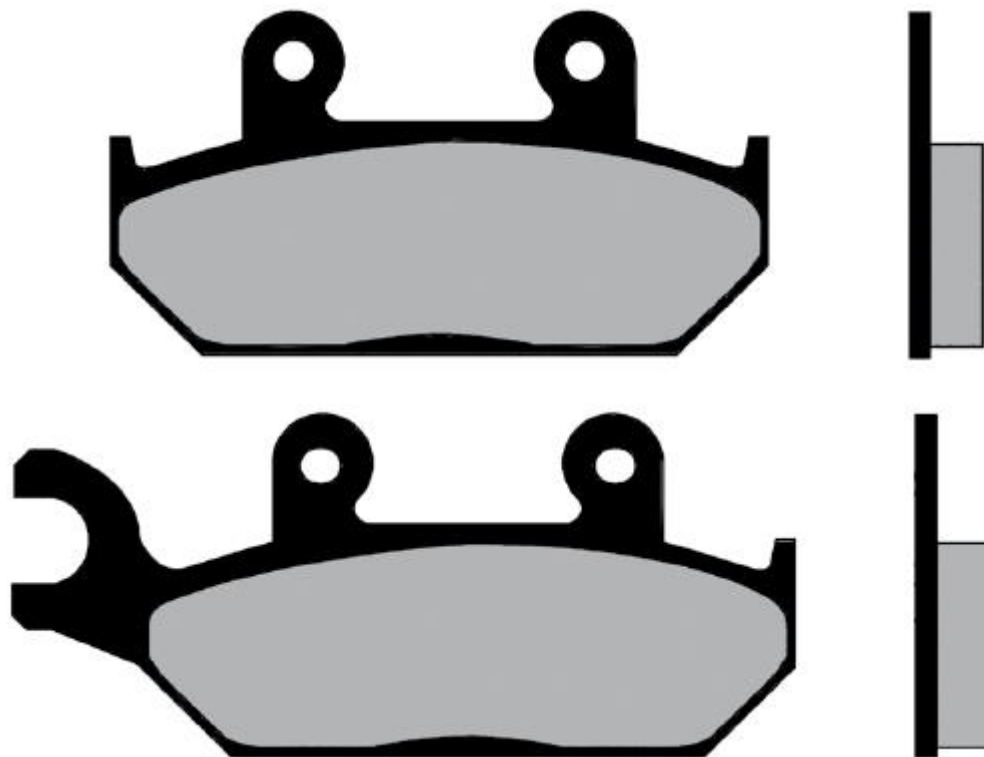

## YAMAHA

TZR	50		93- 02	•
	400	Artesia	91-	•
XT	500	E (Austria)	90- 96	•
XT	600	E	90-	•
XT	600	K	91-	•
XTZ	660	Tenere	91- 98	•



# 3149 ORGANIC

## Brake Pads

A 42,0 | L 70,2 | S 8,1

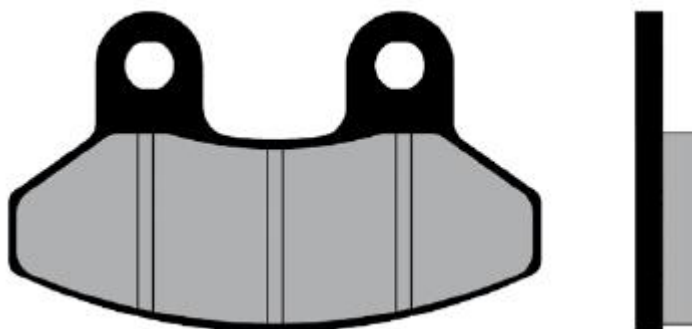

### LAVERDA

	125	Phoenix	01-	•
	150	Phoenix	01-	•
	200	Phoenix	01-	•

### SYM

RS	50		05-	•
RS21	50		02-	•
	125	EuroMX	03-	•
	125	Joyride	01- 09	•
	125	Joyride Evo	10-	•
	125	Joyride S	16-	•
RS	125		05-	•
RS21	125	R	02-	•
VS	125		07-	•
VS	125		09-	•
	150	EuroMX	03-	•
	150	Joyride	01-	•
RS	150		05-	•
VS	150		07-	•
	200	Joyride	01-	•
	200	Joyride S	16-	•

### RIEJU

RS2	125	Pro	08-	•
-----	-----	-----	-----	---





# 3152 ORGANIC

Brake Pads

A 51,0 | L 109,8 | S 8,4

A 36,9 | L 95,2 | S 8,4

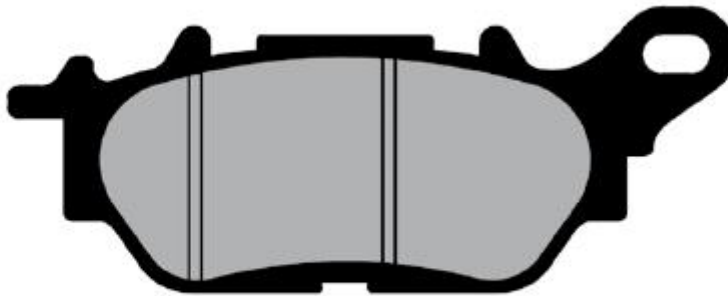
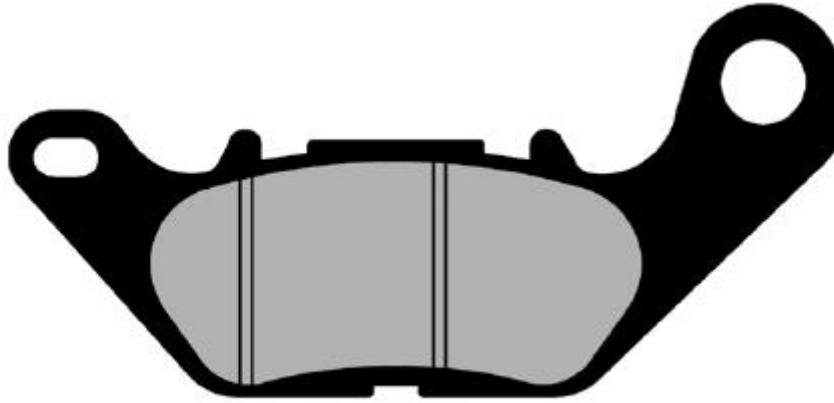

**MBK**

XC	125	Waap	08-	•	
----	-----	------	-----	---	--

**YAMAHA**

	115	D'elight	14-	•	
	125	N-Max	15-		•
XC	125	Vity	08-	•	
YBR	125		08-	•	
	135	CryptonX	08-	•	
	150	N-Max	15-		•
YZF	150	R15	14-	•	

3153 ORGANIC

Brake Pads

A 39,0 | L 90,0 | S 10,3

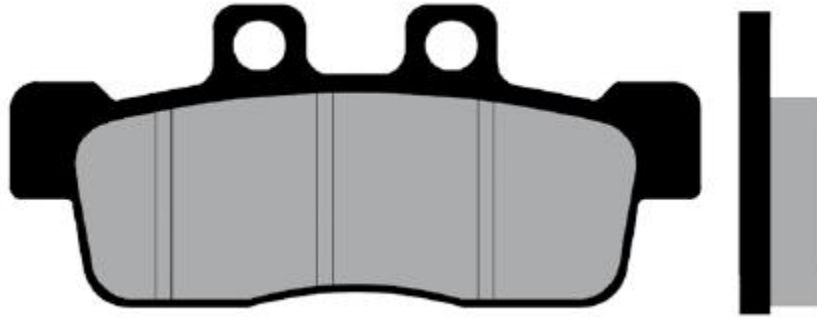

YAMAHA

NXC

125

Cygnus

10-

•

# Brake Pads

3154 ORGANIC

4154 SINTERED

A 45,4 | L 69,4 | S 8,7

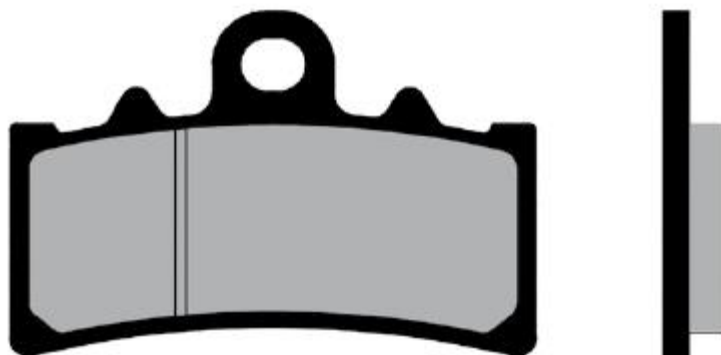

## BMW

G	310	GS	17-	•
G	310	R	16-	•

## HUSQVARNA

	401	Svartpilen	17-	•
	401	Vitpilen	17-	•

## KTM

	125	Duke	11-	•
RC	125		14-	•
	200	Duke	12-	•
RC	200		14-	•
	390	Duke	13-	•
RC	390		14-	•

# Brake Pads

3155 ORGANIC  
4155 SINTERED

A 39,9 | L 86,1 | S 9,0

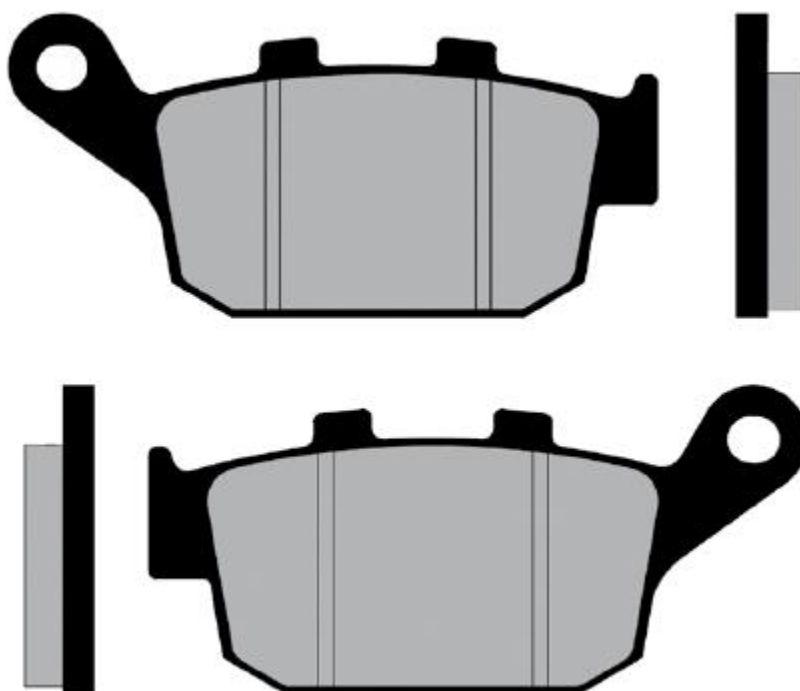

## HONDA

CBR	250	R (Nissin cal)	11- 13	•
CBR	250	R ABS (Nissin cal)	11- 13	•
	300	Rebel	17-	•
CBR	300	F	14-	•
CBR	300	R	15-	•
	500	Rebel	17-	•
CB	500	F	13-	•
CB	500	X	13-	•
CBR	500	R	13-	•
CB	650	F	14-	•
CBR	650	F	14-	•
CBR	650	F ABS	14-	•
CTX	700		14-	•
CTX	700	D ABS w/DCT	14-	•
CTX	700	N	14-	•
CTX	700	ND ABS w/DCT	14-	•
	750	A-ADV	17-	•
NC	750	D Integra	14-	•
NC	750	S w/DCT	14-	•
NC	750	X w/DCT	14-	•
NM4	750	Vultus ABS w/DCT	15-	•
CRF	1000	L Africa Twin	16-	•



**KAWASAKI**

KLE	650	Versys	15-	•
KLE	650	VersysLT	15-	•
Z	750	R	11- 12	•
Z	800		13- 16	•
Z	800	ABS	13- 16	•
Z	800	e	13-	•
Z	800	e ABS	13- 16	•
Z	900		17-	•

**SUZUKI**

SFV	650	Gladius Left/Rear	09-	•
SV	650	Left/Rear	16-	•



# 4157 SINTERED

Brake Pads

A 39,6 | L 97,0 | S 7,0

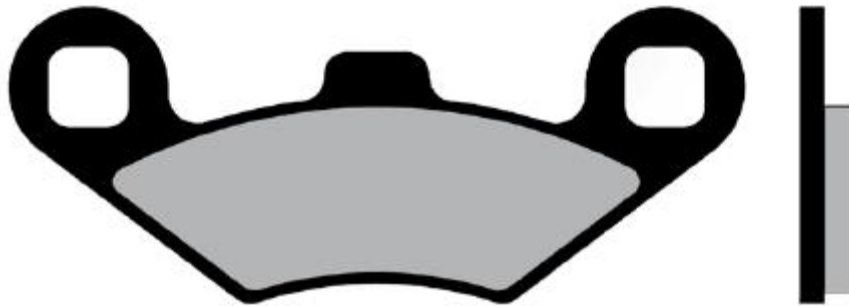

**PEUGEOT**

400	Metropolis	15-	•	•
-----	------------	-----	---	---

**POLARIS**

	Trail Blazer	90- 93	•	
	Trail Boss 2x4, 4x4	88- 89	•	
250	2x4, 4x4	90- 93	•	
250	Big Boss 4x6, 6x6	89- 93	•	
250	Trail Blazer	94-	•	
250	Trail Boss	91- 99	•	
250	Trail Boss 2x4, 4x4	91- 92	•	
250	Xplorer 4x4	00-	•	
300	2x4, 4x4	94- 95	•	
300	Big Boss 6x6	94	•	
300	Hawkeye 2x4, 4x4	07-	•	•
300	Xplorer 4x4	96-	•	
300	Xpress 2x4	98-	•	
300	Xpress L	96- 97	•	
325	Magnum 2x4, 4x4	00- 02	•	
325	Trail Boss	00- 02	•	
330	ATP	04- 05	•	•
330	ATP	06-	•	
330	Magnum 2x4, 4x4	03-	•	
330	Trail Boss	03-	•	
335	Sportsman 4x4	99-	•	
350	Big Boss	93	•	
350	L 2x4, 4x4	90	•	
350	L 4x4	93	•	
350	Sportsman 4x4	93	•	
350	2x4	91- 93	•	
350	Trail Boss L 4x4	91	•	
400	Big Boss L 6x6	96	•	



400	L 2x4	94- 95	•	
400	L 4x4	94	•	
400	Scrambler 2x4, 4x4	00-	•	
400	Scrambler 4x4	98-	•	
400	Scrambler L 4x4	95- 97	•	
400	Sport	99- 00	•	
400	Sport L	94- 98	•	
400	Sportsman	01-	•	
400	Sportsman L 4x4	94- 97	•	
400	Trail Blazer	03-	•	
400	Xplorer L 4x4	95-	•	
400	Xpress L	96- 97	•	
425	2x4, 4x4 Magnum	95- 98	•	
425	Magnum 6x6	96	•	
425	Xpedition 4x4	00-	•	
450	Sportsman	06-	•	
455	Diesel EBS 4x4	99-	•	
500	ATP HO	04-	•	•
500	Big Boss 6x6	98- 99	•	
500	Magnum 2x4, 4x4	02-	•	
500	Magnum 4x4	00- 01	•	
500	Outlaw	06-	•	•
500	Predator	03-	•	•
500	Predator e	06-	•	
500	Ranger 6x6	00- 02	•	
500	Scrambler 2x4	01-	•	
500	Scrambler 4x4	97-	•	
500	Sportsman 4x4	96-	•	
500	Sportsman 6x6	00-	•	
500	Sportsman EBS 4x4	98-	•	
500	Xplorer 4x4	97	•	



# 4159 SINTERED

## Brake Pads

A 42,1 | L 40,8 | S 7,4

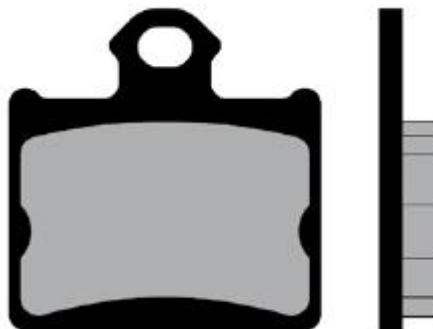

### HUSQVARNA

CR	65		12- 13	•
TC	85		14-	•

### KTM

		Freeride Electric	12-	•
ESM		Freeride	15-	•
ESX		Freeride	15-	•
EXC		Freeride	15-	•
SX	85	(19" / 16" wheels)	13-	•
SX	85		11-	•
	250	Freeride R	14-	•
	350	Freeride	12-	•

# 4160 SINTERED

## Brake Pads

A 31,6 | L 61,8 | S 6,5

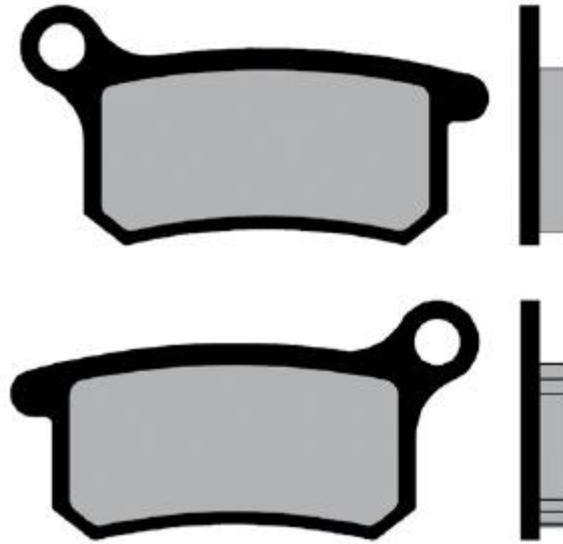

### HUSQVARNA

CR	65	12-13	•	
TC	65	17-	•	•

### KTM

SX	65	02-08	•	
SX	65	09-	•	•
SX	85	04-10	•	•
SX	85	11	•	

# 4161 SINTERED

## Brake Pads

A 39,7 | L 58,6 | S 7,5

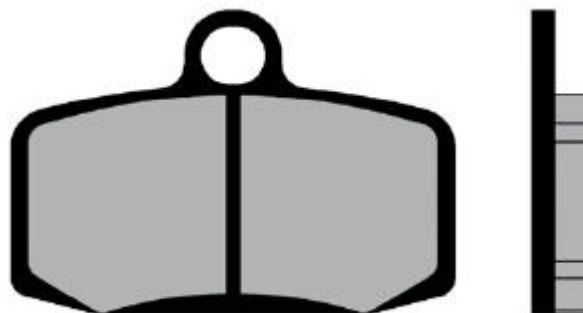

### GAS GAS

TXT	125	(Formula cal.)	12-	•
TXT	250	(Formula cal.)	12-	•
TXT	280	(Formula cal.)	12-	•
TXT	300	(Formula cal.)	12-	•

### HUSQVARNA

TC	85		14-	•
----	----	--	-----	---

### KTM

		Freeride Electric	12-	•
ESM		Freeride	15-	•
ESX		Freeride	15-	•
EXC		Freeride	15-	•
SX	85	85 (19"/16" wheels)	13-	•
SX	85		12-	•
	250	Freeride R	14-	•
	350	Freeride	12-	•

### SHERCO

ST	80	(Formula cal.)	13- 14	•
ST	125	(Formula cal.)	13- 14	•
ST	250	(Formula cal.)	13- 14	•
ST	290	(Formula cal.)	13- 14	•
ST	305	(Formula cal.)	13- 14	•

# 4162 SINTERED

## Brake Pads

A 32,6 | L 98,1 | S 7,6  
A 35,7 | L 110,8 | S 7,6

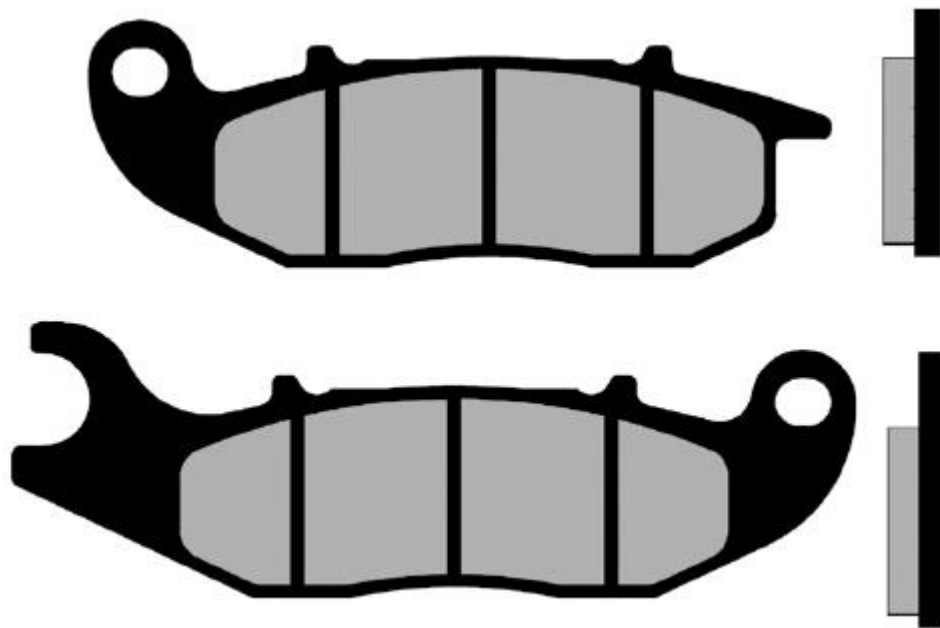

### AJP







PR3	125	Enduro	13-	•
PR3	125	Enduro Pro	13-	•
PR3	125	Extreme	13-	•
PR3	125	Supermoto	13-	•
PR4	125	Enduro	13-	•
PR4	125	Enduro Pro	13-	•
PR4	125	Supermoto	13-	•
PR4	125	Trail	13-	•
PR3	240	MX	13-	•
PR5	250	Enduro	10-	•
PR5	250	Extreme	12-	•
PR5	250	Supermoto	10-	•
PR7	650	Adventure	17-	•

### DERBI

	125	Mulhacen	08-	•
	125	Terra	08-	•
	125	Terra Adventure	08-	•

### HONDA

CRE	125	RR	11-	•
CRF	250	L	13-	•
CRF	250	L ABS	17-	•
CRF	250	M	14-	•

					
CRF	250	Rally	17-	•	
<b>PIAGGIO</b>					
	125	Liberty iGet 4T 3V	17-	•	
	125	Medley	16-	•	
	125	Medley S	17-	•	
	125	New Liberty	16-	•	
	150	Medley	16-	•	
<b>SCORPA</b>					
	250	T-Ride	08-	•	



# 4163 SINTERED

## Brake Pads

A 50,8 | L 127,1 | S 7,4

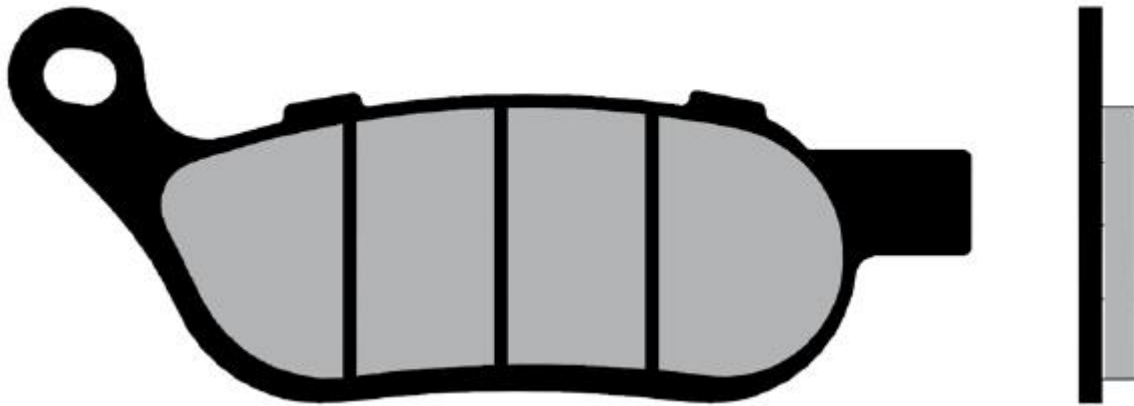

### HARLEY DAVIDSON

FLSIC	1584	Heritage Softail Classic	08-	•
FLSIF	1584	Fat Boy	08-	•
FLSIFB	1584	Fat Boy Special	10-	•
FLSTN	1584	Softail Deluxe	08-	•
FXCW	1584	Rocker	08-	•
FXCWC	1584	Rocker C	08-	•
FXD	1584	Dyna Super Glide	08-	•
FXDB	1584	Dyna Street Bob	08- 13	•
FXDC	1584	Dyna Super Glide Custom	08-	•
FXDF	1584	Fat Bob	08-	•
FXDL	1584	Dyna Low Rider	08-	•
FXDWG	1584	Dyna Wide Glide	08-	•
FXST	1584	Softail Standard	08-	•
FXSIB	1584	Night Train	08-	•
FXSIC	1584	Softail Custom	08-	•
FLD	1690	Switchback	12-	•
FLHRC	1690	Road King Classic	11-	•
FLHTC	1690	Electra Glide Classic	11-	•
FLHTK	1690	Ultra Electra Glide	11-	•
FLS	1690	Softail Slim	12- 15	•
FLS	1690	Softail Slim	16-	•
FLSIC	1690	Heritage Softail Classic	12-	•
FLSIF	1690	Fat Boy	12-	•
FLSIF	1690	Fat Boy Special	12- 14	•
FLSIFB	1690	Fat Boy	12-	•
FLSTN	1690	oftail Deluxe	12-	•
FXDB	1690	Dyna Street Bob	14-	•
FXDBA	1690	Dyna Street Bob	13-	•
FXDBB	1690	Dyna Street Bob	14-	•
FXDBP	1690	Dyna Street Bob	13-	•



EXDC	1690	Dyna Super Glide Custom	14-	•
EXDF	1690	Dyna Wide Glide	12-	•
EXDF	1690	Fat Bob	12-	•
EXDL	1690	Dyna Low Rider	14-	•
EXDLS	1690	Dyna Low Rider S	17-	•
FXS	1690	Blackline	13-	•
FXSB	1690	Breakout	14-	•
FLSS	1802	Softail Slim S	16-	•
FLSTFBS	1802	Fat Boy SCVO Softail Deluxe	14-	•
FXSBSE	1802	CVO Breakout	13-	•

# 4164 SINTERED

## Brake Pads

A 63,9 | L 97,5 | S 8,0

A 63,6 | L 97,6 | S 8,0

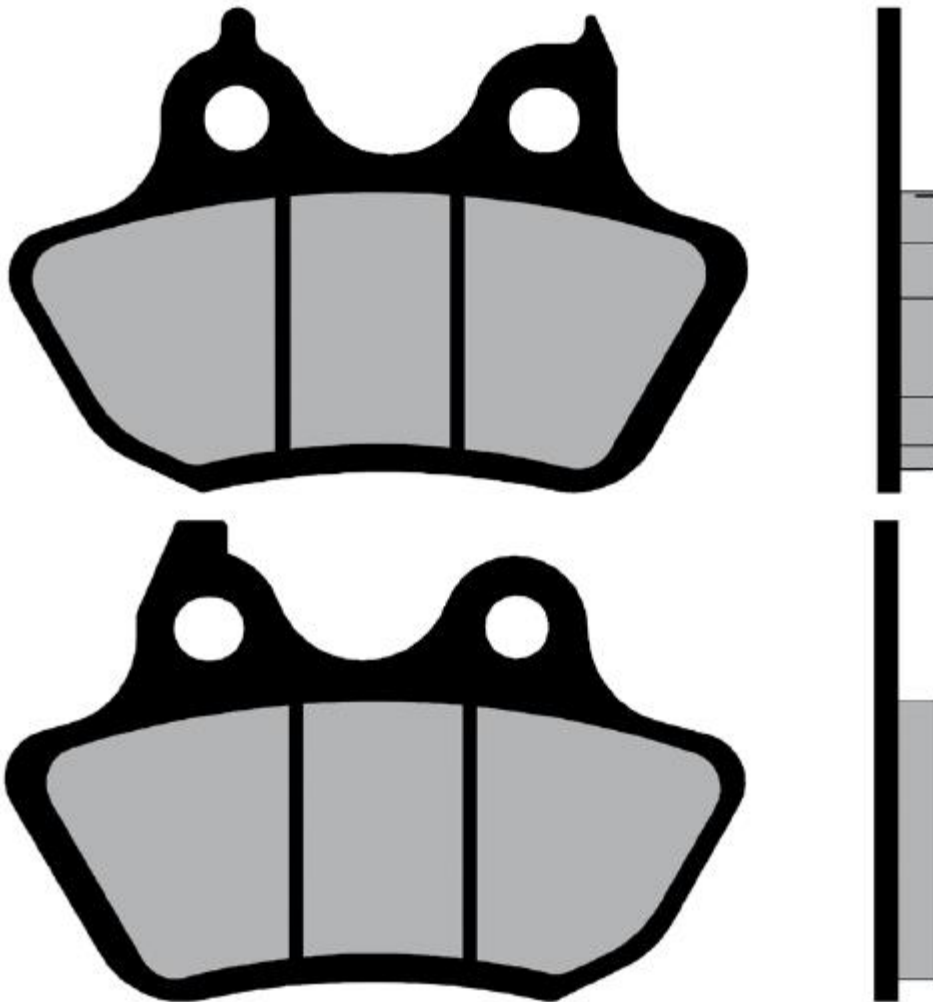

### HARLEY DAVIDSON

FLSTI	1450	Heritage Softail	06	•
FXDI	1450	Anniversary Super Glide	06	•
FXST/I	1450	Softail Standard	06	•
FXSTB/I	1450	Night Train	06	•
FXSTD/I	1450	Softail Deice	06	•
FXSIS/I	1450	Softail	06	•
FLSTC	1584	Heritage Softail Classic	07	•
FLSIF	1584	Fat Boy	07	•
FLSTN	1584	Softail Deluxe	07	•
FLSTSC	1158	Softail	07	•
FXST	1584	Softail Standard	07	•
FXSTB	1584	Night Train	07	•
FXSTC	1584	Softail Custom	07	•
FXSTD	1584	Softail Deice	07	•

# 4165 SINTERED

## Brake Pads

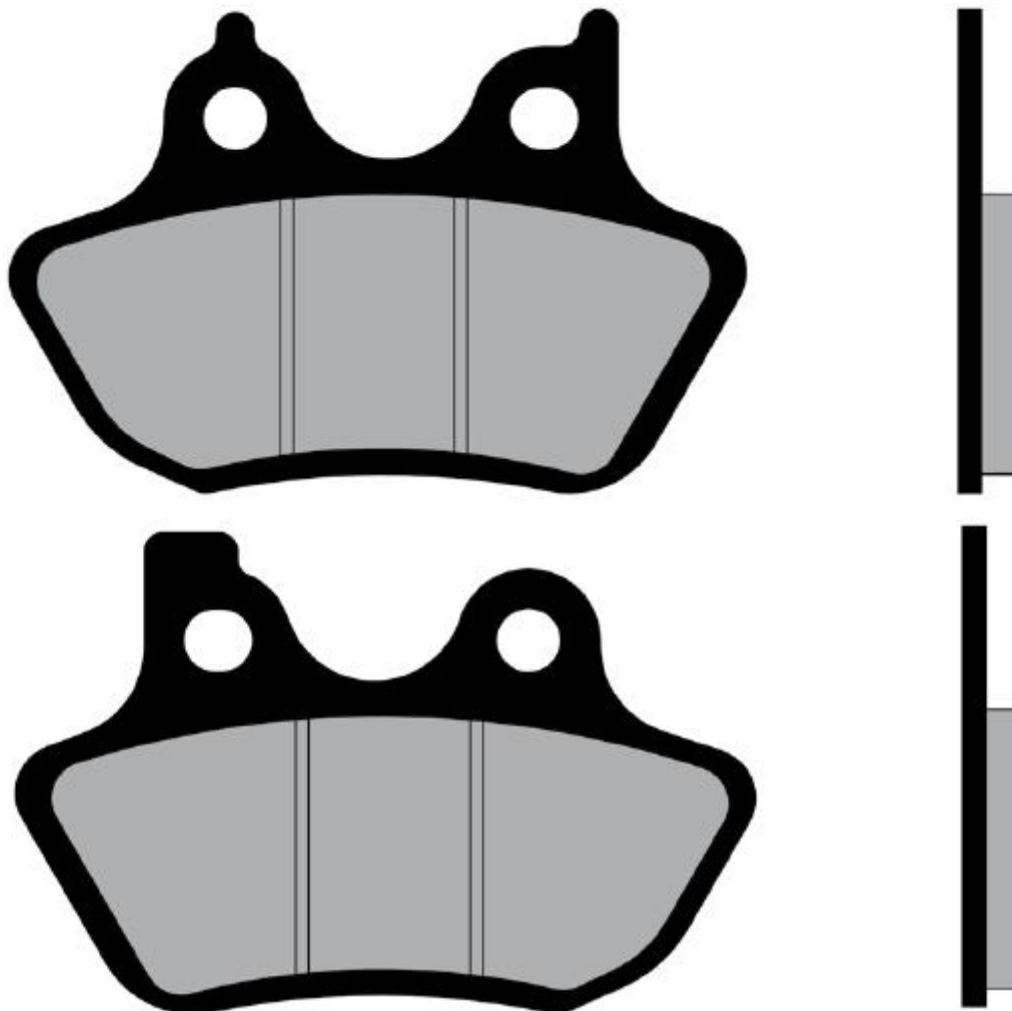

A 64,0 | L 97,3 | S 8,0

A 63,1 | L 97,3 | S 8,0



### HARLEY DAVIDSON

XL	883	R Sportster	00-03	•	•
XL	883	Sportster Custom	00-03	•	•
XLH	883	Sportster	00-03	•	•
XLH	883	Sportster Hugger	00-03	•	•
VRSCA	1130	V-Rod	02-05	•	•
VRSCB	1130	V-Rod	04	•	•
XL	1200	Sportster Custom	00-03	•	•
XL	1200	Sportster Sport	00-03	•	•
XLH	1200	Sportster	00-03	•	•
FLHR/I	1450	Road King	00-06	•	•
FLHRCI	1450	Road King Classic	00-06	•	•
FLHRS/I	1450	Road King Custom	04-06	•	•
FLHT/I	1450	Electra Glide Standard	00-06	•	•
FLHTC/I	1450	Electra Glide Classic	00-06	•	•
FLHTCUI	1450	Ultra Classic Electra Glide	00-06	•	•

					
FLSTC	1450	Softail	06-07	•	•
FLSTC/I	1450	Heritage Softail Classic	00-04	•	•
FLSTCI	1450	Softail	06	•	•
FLSIF	1450	Fat Boy	06-07	•	•
FLSIF/I	1450	Fat Boy	00-04	•	•
FLSIFI	1450	Fat Boy	06	•	•
FLSTI	1450	Heritage Softail	06	•	
FLSTN/I	1450	Softail Deluxe	06	•	•
FLSIS/I	1450	Heritage Springer	00-03		•
FLSTSC	1450	Springer Softail Classic	06		•
FLTR/I	1450	Road Glide Classic	00-06	•	•
FXD	1450	Dyna Super Glide	00-03	•	•
FXDBI	1450	Dyna Street Bob	06	•	•
FXDC/I	1450	Dyna Super Glide Custom	05-06	•	•
FXDI	1450	35th Anniversary Super Glide	06	•	
FXDI	1450	Dyna Super Glide	04-07	•	•
FXDL	1450	Dyna Low Rider	00-03	•	•
FXDLI	1450	Dyna Low Rider	04-06	•	•
FXDS	1450	Dyna Convertible	00-02	•	•
FXDWG	1450	Dyna Wide Glide	00-03	•	•
FXDWGI	1450	Dyna Wide Glide	04-06	•	•
FXDX	1450	Dyna Super Glide Sport	00-03	•	•
FXDXI	1450	Dyna Super Glide Sport	04-06	•	•
FXDXT	1450	Dyna Super Glide T-Sport	00-03	•	•
FXST/I	1450	Softail Standard	00-05	•	•
FXST/I	1450	Softail Standard	06	•	
FXSTB/I	1450	Night Train	00-05	•	•
FXSTB/I	1450	Night Train	06	•	
FXSTD/I	1450	Softail Deuce	00-05	•	•
FXSTD/I	1450	Softail Deuce	06	•	
FXSIS/I	1450	Softail	05		•
FXSIS/I	1450	Springer Softail	00-04		•
FLHR	1584	Road King	07	•	•
FLHRC	1584	Road King Classic	07	•	•
FLHRS	1584	Road King Custom	07-	•	•
FLHT	1584	Electra Glide Standard	07	•	•
FLHTC	1584	Electra Glide Classic	07	•	•
FLHTCU	1584	Ultra Classic Electra Glide	07-10	•	•
FLHX	1584	Street Glide	07	•	•
FLSTC	1584	Heritage Softail Classic	07	•	
FLSIF	1584	Fat Boy	07	•	
FLSTN	1584	Softail Deluxe	07	•	
FXD	1584	Dyna Super Glide	07	•	•
FXDB	1584	Dyna Street Bob	07	•	•
FXDC	1584	Dyna Super Glide Custom	07	•	•
FXDL	1584	Dyna Low Rider	07	•	•
FXDWG	1584	Dyna Wide Glide	07	•	•
FXST	1584	Softail Standard	07	•	
FXSTB	1584	Night Train	07	•	
FXSTC	1584	Softail Custom	07	•	
FXSTD	1584	Softail Deuce	07	•	

4166 SINTERED

Brake Pads

A 45,4 | L 101,6 | S 8,9

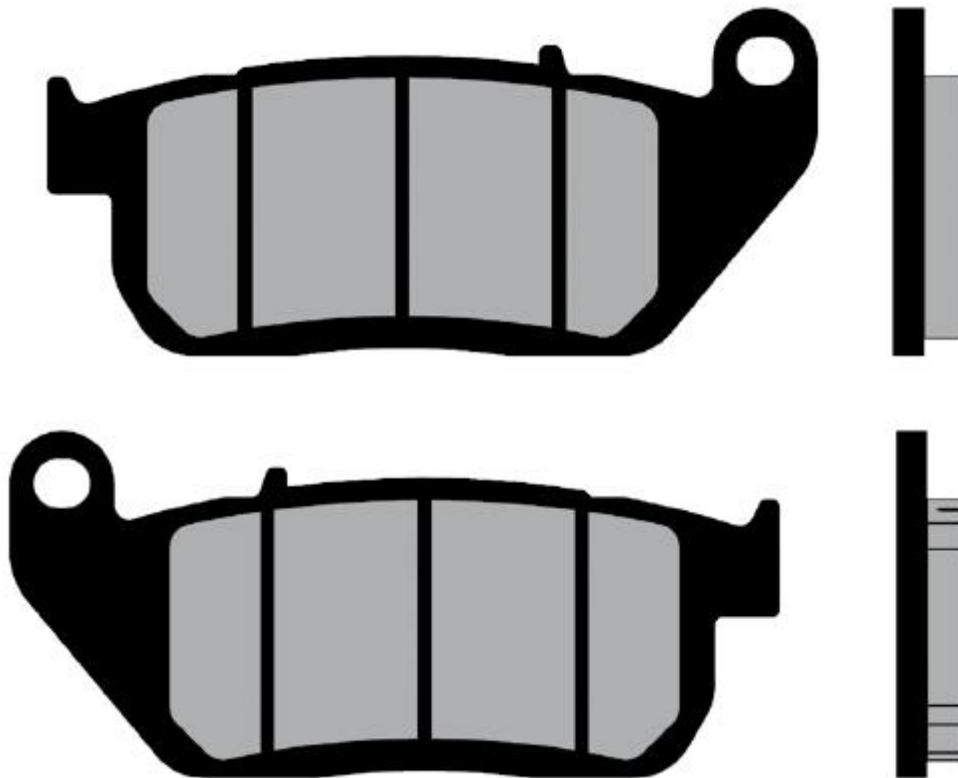

**HARLEY DAVIDSON**

XL	883	C Sportster Custom	04- 13	•
XL	883	L Sportster Low	06- 13	•
XL	883	L Super Low	11- 13	•
XL	883	N Iron	13	•
XL	883	R Roadster	10- 13	•
XL	883	Sportster	04- 13	•
XL	883	Sportster R	05- 13	•
XL	1200	C Sportster Custom	04-	•
XL	1200	L Sportster Low	07-	•
XL	1200	N Nightster	07-	•
XL	1200	R Sportster Roadster	04-	•
XL	1200	V Seventy-Two	11- 13	•
XL	1200	X Forty-Eight	11- 13	•

4167 SINTERED

Brake Pads

A 44,3 | L 85,7 | S 10,0

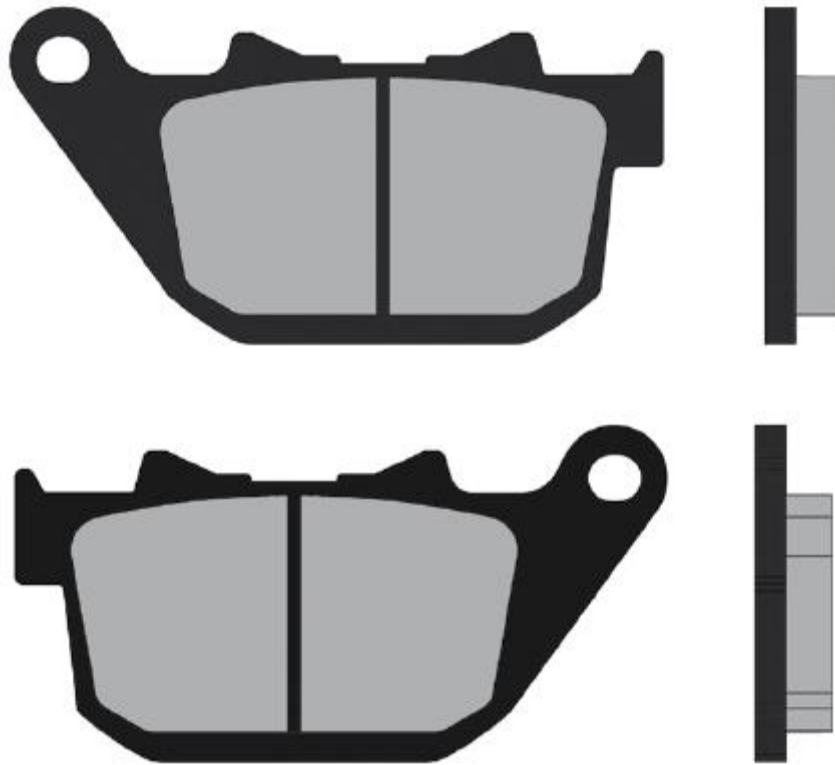

**HARLEY DAVIDSON**

XL	883	C Sportster Custom	04- 13	•
XL	883	L Sportster Low	06- 13	•
XL	883	L Super Low	11- 13	•
XL	883	N Iron	13	•
XL	883	R Roadster	10- 13	•
XL	883	Sportster	04- 13	•
XL	883	Sportster R	05- 13	•
XL	1200	C Sportster Custom	04-	•
XL	1200	L Sportster Low	07-	•
XL	1200	N Nightster	07-	•
XL	1200	R Sportster Roadster	04-	•
XL	1200	V Seventy-Two	11- 13	•
XL	1200	X Forty-Eight	11- 13	•
XR	1200		08-	•
XR	1200	X	10-	•

# 4168 SINTERED

Brake Pads

A 36,5 | L 93,9 | S 9,0

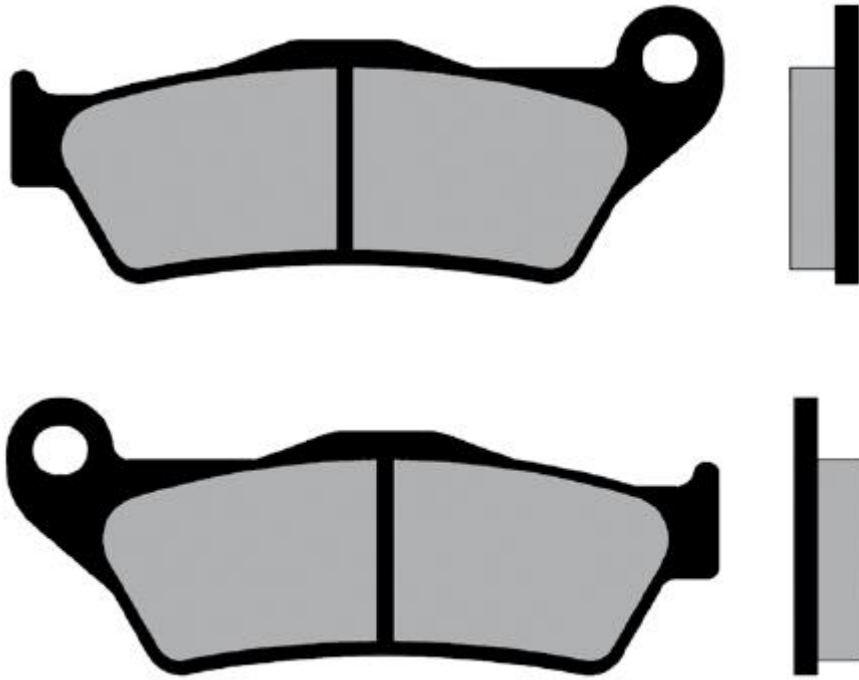

**HARLEY DAVIDSON**

XG	500	Street	14- 15	•	•
XG	750	Street	14- 15	•	•



5169 CERAMIC

Brake Pads

A 28,7 | L 82,1 | S 9,6



**ACCOSSATO**

AGPZ05, 100 mm CNC Monoblock, 4 Piston/2 Pad

AGPZ07, 100 mm Forged Monoblock, 4 Piston/2 Pad

**BREMBO RACING CALIPERS**

Radial Monoblock XA8Y310/11

# 4170 SINTERED

## Brake Pads

A 55,2 | L 73,8 | S 9,0

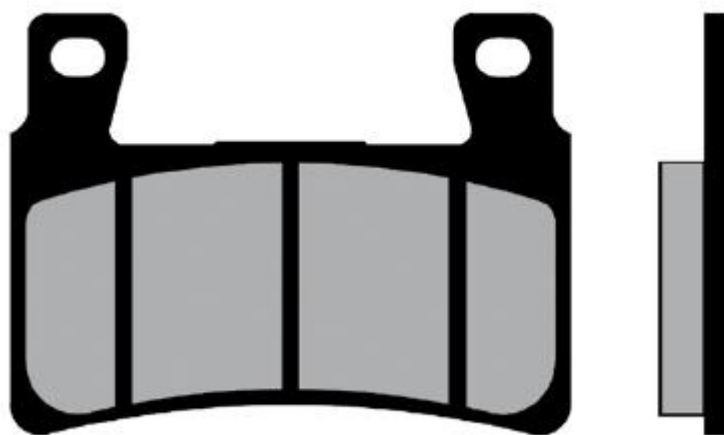

### HARLEY DAVIDSON

XR	1200		08-	•
XR	1200	X	10-	•
FXST	1584	Softail Standard	15-	•
FLS	1690	Softail Slim	15	•
FLS	1690	Softail Slim	16-	•
FLSTC	1690	Heritage Softail Classic	15-	•
FLSIF	1690	Fat Boy	15-	•
FLSIFB	1690	Fat Boy	15-	•
FLSTN	1690	Softail Deluxe	15-	•
FXSB	1690	Breakout	15-	•
FLSS	1802	Softail Slim S	16-	•
FLSIFBS	1802	Fat Boy S	16-	•
FLSINSE	1802	CVOSoftail Deluxe	15-	•

# 4171 SINTERED

## Brake Pads

A 58,1 | L 91,5 | S 7,0

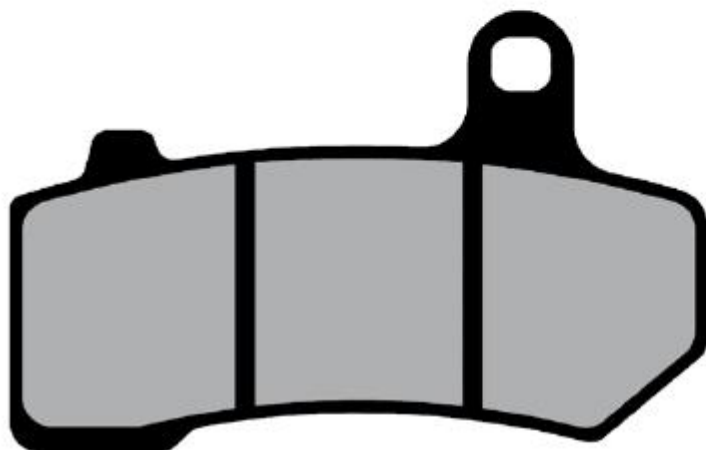
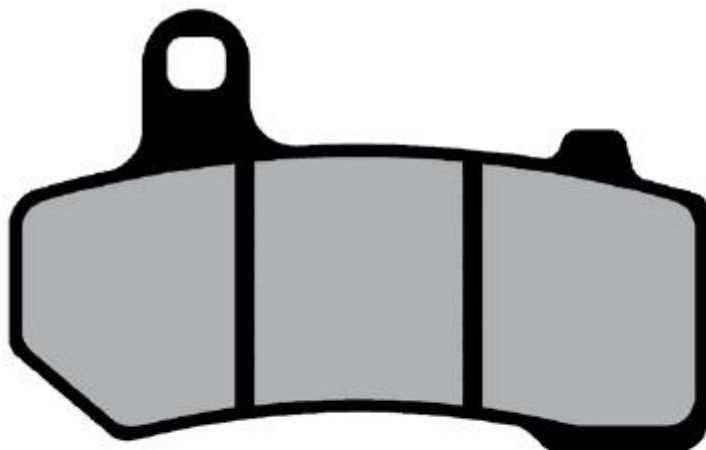

### HARLEY DAVIDSON

VRSCA	1130	V-Rod	06-	•	•
VRSCD	1130	Night Rod	06-	•	•
VRSCR	1130	Street Rod	06-	•	•
VRSCAW	1250	V-Rod	08-	•	•
VRSCDX	1250	Night Rod	08-	•	•
VRSCF	1250	Muscle	09-	•	•
VRSCX	1250	V-Rod	08-	•	•
FLHR	1584	Road King	08- 10	•	•
FLHRC	1584	Road King Classic	08-	•	•
FLHT	1584	Electra Glide Standard	08-	•	•
FLHTC	1584	Electra Glide Classic	08-	•	•
FLHTCi	1584	Ultra Electra Glide Classic	08-	•	•
FLHTK	1584	Electra Glide Ultra LTD	10-	•	•
FLHX	1584	Street Glide	08-	•	•
FLTR	1584	Road Glide	08-	•	•
FLTRU	1584	Road Glide Ultra	11- 16	•	•
FLTRX	1584	Road Glide Custom	10-	•	•



FLHR	1690	Road King	11- 15	•	•
FLHR	1690	Road King	16	•	•
FLHTCU	1690	Ultra Classic Electra Glide	11- 16	•	•
FLHTCUL	1690	Electra Glide Ultra Classic Low	15-	•	•
FLHTCUTG	1690	Tri Glide Ultra Classic Trike	09- 13	•	
FLHTK	1690	Ultra Classic Electra Glide	10-	•	•
FLHTKL	1690	Ultra Limited Low	15- 16	•	•
FLHX	1690	Street Glide	11- 16	•	•
FLHXS	1690	Street Glide Special	14- 16	•	•
FLHXXX	1690	Street Glide Trike	10-	•	
FLTRX	1690	Road Glide	15- 16	•	•
FLTRXS	1690	Road Glide Special	15- 16	•	•
FLHR	1750	Road King	17-	•	•
FLHRC	1750	Road King Classic	17-	•	•
FLHTCU	1750	Ultra Classic Electra Glide	17-	•	•
FLHTK	1750	Ultra Limited	17-	•	•
FLHTKL	1750	Ultra Limited Low	17-	•	•
FLHX	1750	Street Glide	17-	•	•
FLHXS	1750	Street Glide Special	17-	•	•
FLTRU	1750	Road Glide Ultra	17-	•	•
FLTRX	1750	Road Glide	17-	•	•
FLTRXS	1750	Road Glide Special	17-	•	•
FLHRSE5	1802	CVO Road King	14-	•	•
FLHTKSE	1802	CVO Limited	14- 16	•	•
FLHXSE	1802	CVO Street Glide	10- 16	•	•
FLTRUSE	1802	CVO Road Glide Ultra	11-	•	•
FLHTKSE	1870	CVO Limited	17-	•	•
FLHXSE	1870	CVO Street Glide	17-	•	•

4172 SINTERED

Brake Pads

A 61,8 | L 88,6 | S 8,0

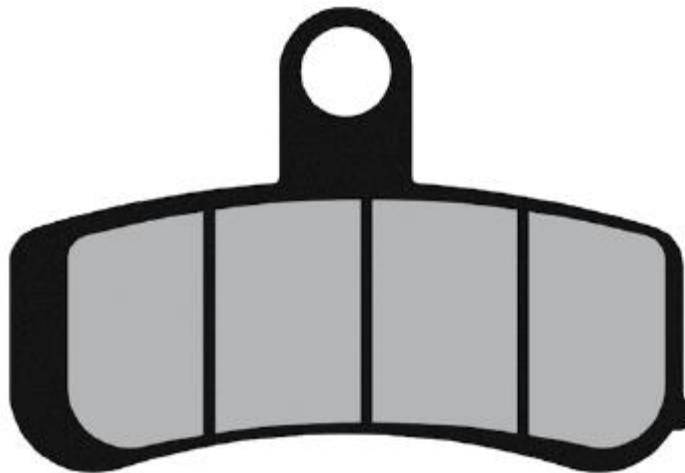
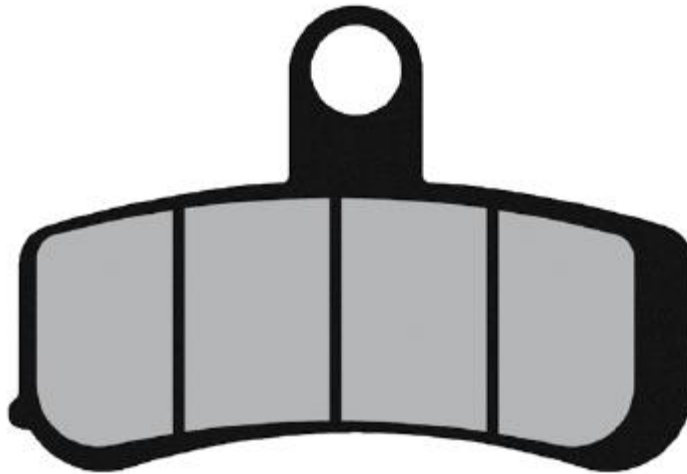

**HARLEY DAVIDSON**

FLSTC	1584	Heritage Softail Classic	08-	•
FLSIF	1584	Fat Boy	08-	•
FLSIFB	1584	Fat Boy Special	10-	•
FLSTN	1584	Softail Deluxe	08-	•
EXCW	1584	Rocker	08-	•
EXCWC	1584	Rocker C	08-	•
FXD	1584	Dyna Super Glide	08-	•
FXDB	1584	Dyna Street Bob	08- 13	•
FXDC	1584	Dyna Super Glide Custom	08-	•
FXDF	1584	Fat Bob	08-	•
FXDL	1584	Dyna Low Rider	08-	•
FXDWG	1584	Dyna Wide Glide	08-	•
FXST	1584	Softail Standard	08- 14	•



FXSIB	1584	Night Train	08-	•
FXSTC	1584	Softail Custom	08-	•
FLD	1690	Switchback	12-	•
FLHRC	1690	Road King Classic	11-	•
FLHTC	1690	Electra Glide Classic	11-	•
FLHTK	1690	Ultra Electra Glide	11-	•
FLS	1690	Softail Slim 12- 14	12- 14	•
FLSTC	1690	Heritage Softail Classic	12- 14	•
FLSIF	1690	Fat Boy	12- 14	•
FLSIF	1690	Fat Boy Special	12- 14	•
FLSIFB	1690	Fat Boy	12- 14	•
FLSTN	1690	Softail Deluxe	12- 14	•
FXDB	1690	Dyna Street Bob	14-	•
FXDBA	1690	Dyna Street Bob	13-	•
FXDBB	1690	Dyna Street Bob	14-	•
FXDBP	1690	Dyna Street Bob	13-	•
FXDC	1690	Dyna Super Glide Custom	14-	•
EXDF	1690	Dyna Wide Glide	12-	•
EXDF	1690	Fat Bob	12-	•
EXDL	1690	Dyna Low Rider	14-	•
EXDLS	1690	Dyna Low Rider S	17-	•
FXS	1690	Blackline	13-	•
FXSB	1690	Breakout	14	•
FLSINSE	1802	CVO Softail Deluxe	14	•
FXSBSE	1802	CVO Breakout	13-	•

# Brake Pads

3173 ORGANIC

4173 SINTERED

A 44,3 | L 64,0 | S 9,4

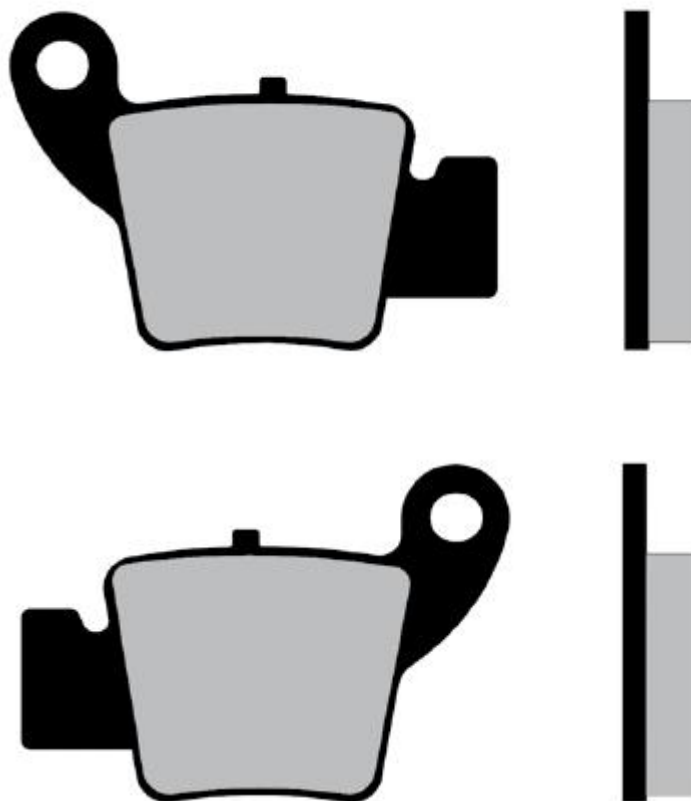

## AJP

PR3	125	Trial	13-15	•
PR3	125	Enduro	13-15	•
PR3	125	EnduroPRO	13-15	•
PR3	125	Extreme	13-	•
PR3	125	Supermoto	13-15	•
PR4	125	Enduro	13-15	•
PR4	125	Enduro Pro	13-15	•
PR4	125	Extreme	13-15	•
PR4	125	Supermoto	13-15	•
PR3	200	Enduro	13-14	•
PR3	200	Enduro Pro	13-14	•
PR3	200	M/XPro	13-14	•
PR3	240	M/XPro	13-15	•
PR5	250	Extreme	12-	•

# Brake Pads

3174 ORGANIC

4174 SINTERED

A 53,1 | L 72,4 | S 8,0

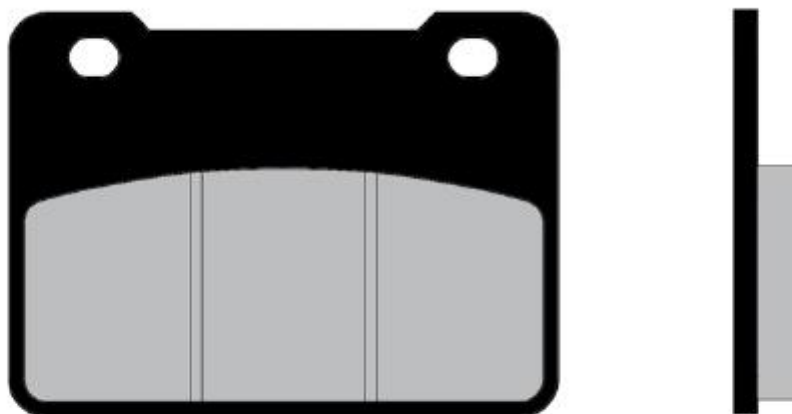

**SYM**

SN	250	Ni Wolf	14-	•
SN	250	T2 Wolf	12-	•
	300	Cruisym	17-	•
	300	Wolf Cafe Racer	15-	•
	300	Wolf Classic	15-	•
SB	300	Cafe Racer	16-	•
	400	iMaxsym	12-	•
	600	iMaxsym	14-	•







# 3177 ORGANIC

Brake Pads

A 63,0 | L 78,8 | S 13,3

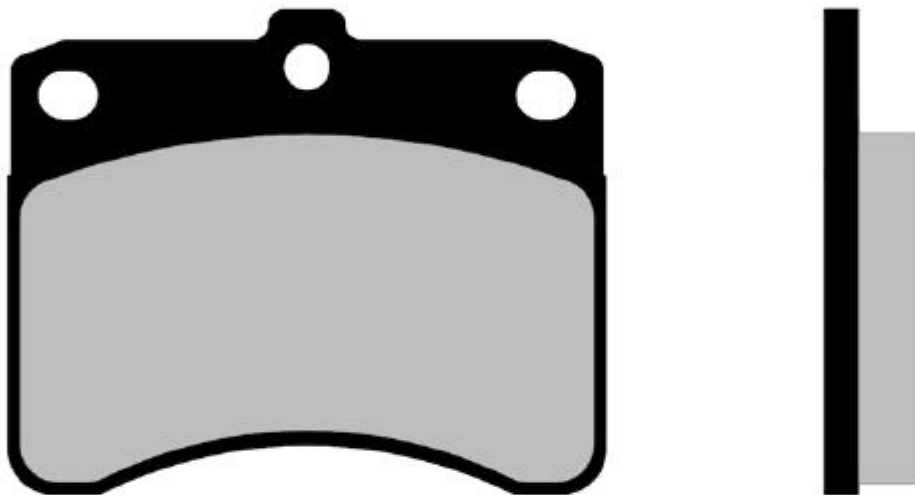

**PIAGGIO Commercial Vehicles**

500	Quargo		•
1000	Porter (Carburatore)	92-94	•
1000	Porter (Iniezione)	95-98	•
1200	Porter (Diesel)	95-00	•
1300	Porter 16v 4X4	98-07	•
1300	Porter 16v GPL	98-07	•
1300	Porter 16v Maxxi	98-07	•
1300	Porter 16v Pick Up	98-07	•
1300	Porter 16 v Van	98-07	•
1300	Porter Maxxi Up Date	09-	•
1300	Porter Up Date	09-	•
1400	Porter Diesel	95-00	•

# 3178 ORGANIC

Brake Pads

A 41,0 | L 74,5 | S 9,0  
A 44,5 | L 85,0 | S 9,0

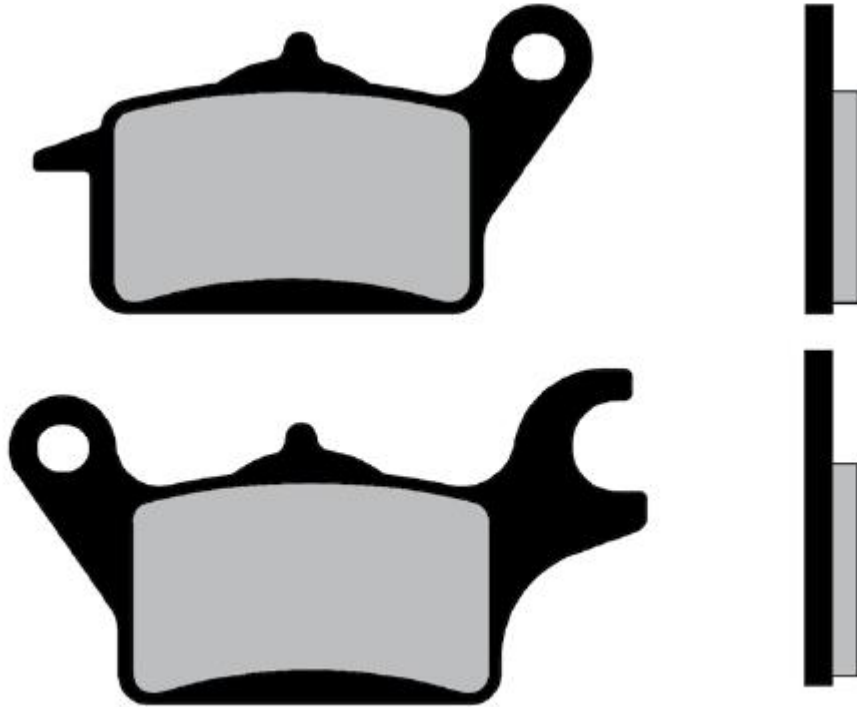

YAMAHA

125

Tricity Left/Rear

14-

•

# 3179 ORGANIC

Brake Pads

A 41,0 | L 74,5 | S 9,0

A 44,5 | L 85,0 | S 9,0

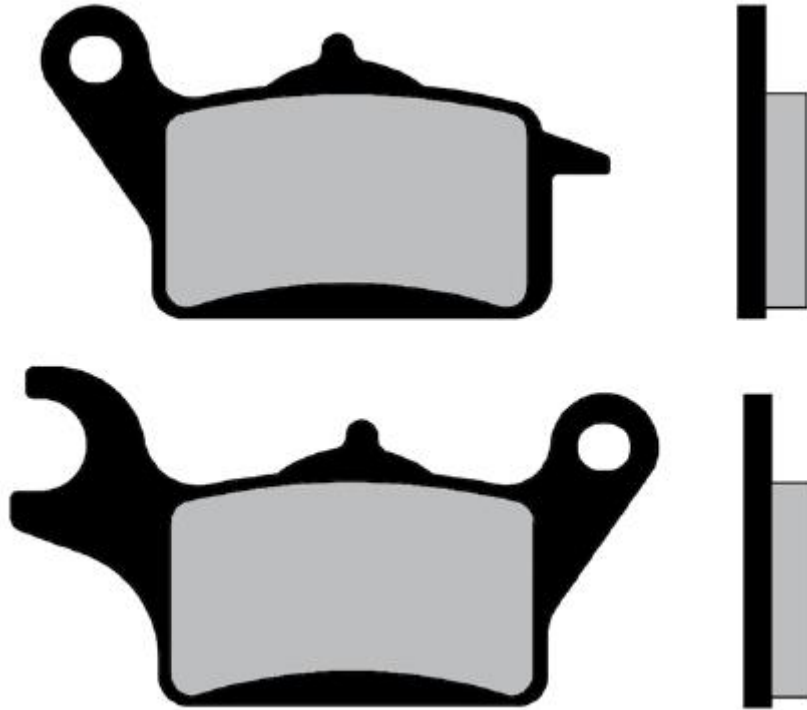

YAMAHA

125

Tricity Right

14-

•

# 3180 ORGANIC

Brake Pads

A 41,0 | L 74,5 | S 7,0  
A 44,5 | L 85,0 | S 7,0

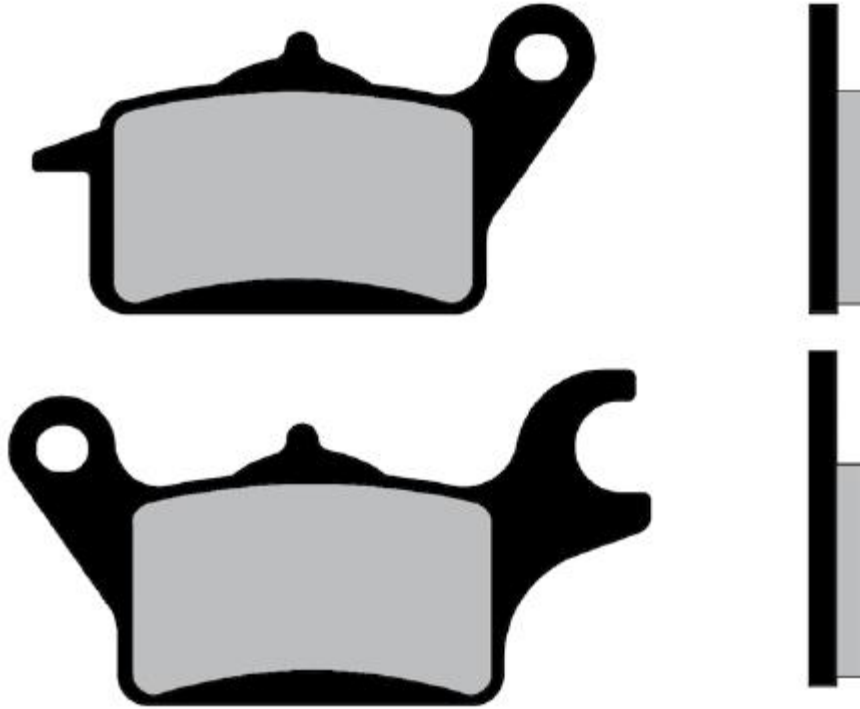

**HONDA**

AFS	110	Wave	12-	•
-----	-----	------	-----	---

**KAWASAKI**

Z	125	Pro	17-	•
---	-----	-----	-----	---



# 3183 ORGANIC

## Brake Pads

A 36,6 | L 51,8 | S 8,0

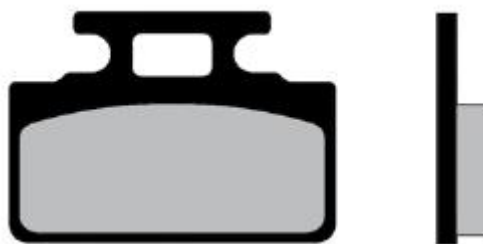

### HONDA

NH	50	Lead	86- 93	•
R	50	Monkey	88-	•
NH	80	Lead Scooter	86-	•
R	80	Lead	88-	•
NS	125		89	•
R	125	Lead	88-	•
RS	125		95-	•
RS	125	R	91- 94	•
NS	250		89	•
RS	250	R	93-	•

### MORIWAKI

MD	250		09-	•
----	-----	--	-----	---

### KYMCO

	50	Manboy	95-	•
	50	Zap (DiscBrake version)	95-	•
SP	90	Yup	95-	•

### SYM

	50	Bullet	93	•
	50	Cinderella	01-	•
	50	Feel-big	98-	•
	50	Mio	05-	•
	50	Pure	98-	•
DD	50		02-	•
	100	Cinderella	01-	•
	100	Mio	05-	•



# 3184 ORGANIC

Brake Pads

A 37,9 | L 85,5 | S 8,8

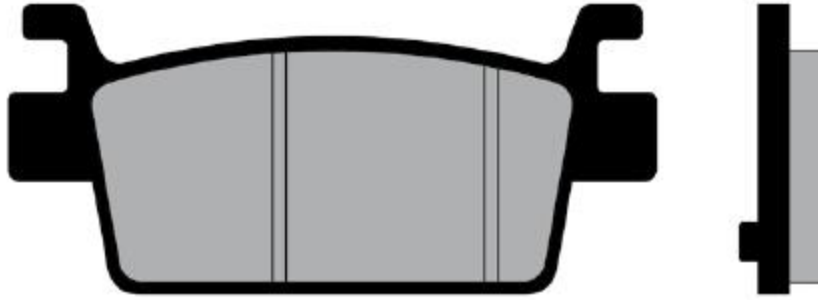

**KYMCO**

AK

550

17-

.

# 3185 ORGANIC

## Brake Pads

A 49,2 | L 89,9 | S 9,0

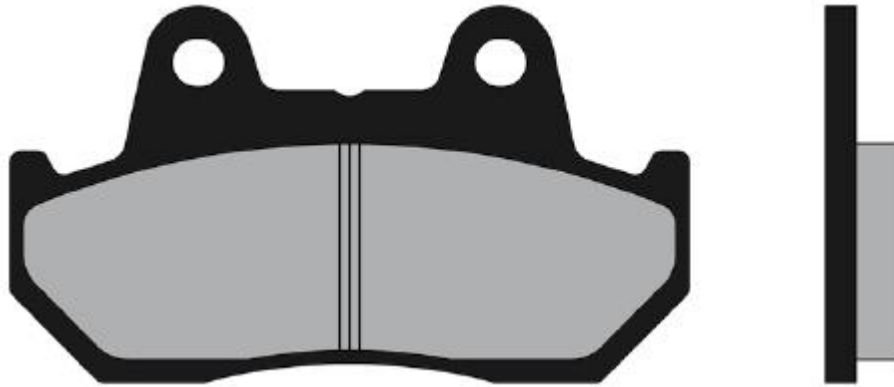

### HONDA

CB	125	T,Superdream	82-	•
CBX	125	F	84- 88	•
CN	250		93-	•
CN	250	Helix (Fusion)	92	•
CBX	250	S	88-	•
CN	250	Scooter	88- 92	•
CN	250	Spazio	88- 92	•
NS	250	R	85	•
CM	400	C	81	•
NS	400	R	85- 87	•
VF	400	Integra	86-	• •
CB	450	SCNighthawk	83- 86	•
CX	500		81-	•
CX	500	Euro	82-	• •
CX	500	Turbo	82- 83	• •
GL	500		82	•
GL	500	I	81- 82	•
CX	650	E	83-	•
VF	700	CMagna	85- 86	•
VF	700	FInterceptor	84- 85	•
CB	750	SC	82- 83	•
XLV	750	R	86- 88	•
CB	900	F, F2	81- 84	•
CBX	1000		81- 82	•
GL	1100	GoldWing	82- 83	•
VF	1100	C	83- 86	•
VF	1100	S	84- 85	•
GL	1200	A, IGoldWing	84- 86	•
GL	1200	DXGoldWing	86-	•
GL	1200	GoldWing	84- 86	•

### XINGFU

XF	150	A	97-	•
----	-----	---	-----	---

# 3186 ORGANIC





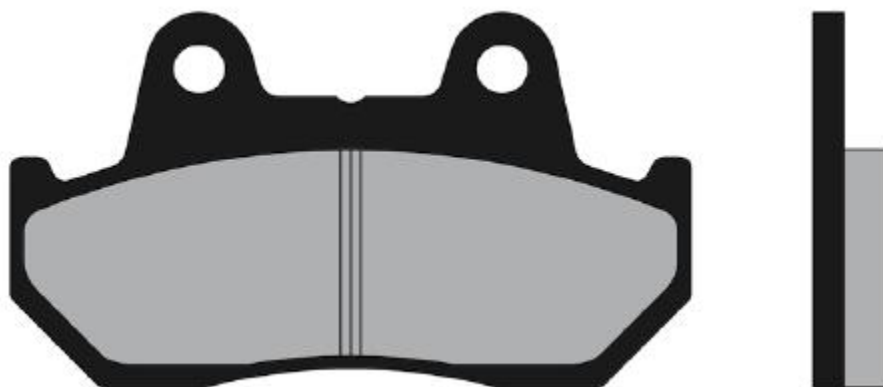

## Brake Pads

A 49,2 | L 89,9 | S 11,0



### HONDA

CB	125	TDC	83- 89	•	
CBX	250	RSE	84-	•	
CN	250	Helix	86- 87	•	
GB	250	Clubman	88-	•	
NS	250	R	85		•
NSR	250	R	87-		•
	400	Xelvis		•	•
CB	400		81-	•	•
CB	400	Four	81-	•	
CB	400	Hawk	81-	•	•
CB	400	N	82-	•	
CB	400	Twin	82-	•	
CBR	400	F, FH	85	•	•
CBR	400	R	87		•
CM	400	T	82-	•	
GB	400	T.T.	88-	•	
NS	400	R	85- 87		•
NV	400	Custom	88		•
CB	450	T	82-	•	
CM	450	A.C	82-	•	
CMX	450	Rebel	86- 88	•	
CBR	500	F (Austria)	87- 90		•
CX	500	C	81- 82	•	
CX	500	Silver W., Turbo	83-	•	•
CX	500	Turbo	82- 83	•	
FT	500		82-	•	•
GB	500	T.T.	88-	•	
GL	500		82		•
GL	500	D	81- 82	•	
NS	500	R	85-	•	•

					
VF	500	F, FII	84- 86	•	•
VT	500	CShadow	83- 86	•	
XBR	500	S	85- 89	•	
CB	550	SC	83-	•	
CBR	600	F Hurricane	87- 90		•
CBX	600	E	85-	•	
XL	600	LM, RM	85-	•	
XL	600	V, Transalp	87- 90	•	
CB	650		85-	•	
CB	650	SC Nighthawk	83- 85	•	
CBX	650	ED, SC, SCD	83-	•	
CX	650	C	83-	•	
CX	650	E	83-		•
CX	650	Turbo	83-	•	•
GL	650	D	83- 84	•	
CB	700	SC	84- 86	•	
VF	700	C Magna	84	•	
VF	700	C Magna	87	•	
VF	700	F Interceptor	84- 85		•
VF	700	S	84- 85	•	
VFR	700	F, F2	86- 87		•
VT	700	C, Shadow	87	•	
CB	750	C	82-	•	
CB	750	C, F, FII, K	85-	•	
CB	750	F	81- 82	•	•
CB	750	K	81-	•	•
CB	750	KZ	82-	•	
CBR	750	Hurricane	87-		•
CBX	750		84- 88	•	•
CBX	750	F	84- 88	•	•
NV	750	CG Shadow	86-	•	
VF	750	C	82-	•	
VF	750	C, Magna	88- 93	•	
VF	750	F	83- 84	•	•
VF	750	S	85	•	
VF	750	Sport	82- 83	•	
VFR	750	F	86- 87		•
VP	750	CH, Custom	87-	•	
VT	750	C, Shadow	86-	•	
XLV	750	R	83- 85	•	
VT	800	C	88-	•	
CB	900	C	82-	•	•
CB	900	F, F2	81- 84		•
CB	1000	C	83-	•	•
CBR	1000	F	87- 88		•
CBX	1000		81- 82		•
VF	1000	F, FII	84- 86	•	•
VF	1000	FII Bol d'Or	85	•	•
VF	1000	R	84- 87	•	
VF	1000	R	86-	•	•
VT	1000	C	88-	•	
CB	1100	F	83-	•	•
CB	1100	R	81- 83	•	•
CB	1100	RD	83-	•	•
GL	1100	DLX GoldWing	81-	•	•
GL	1100	GoldWing	82- 83		•
VF	1100	C	83- 86		•
VF	1100	S	84- 85		•
VT	1100	CShadow	87- 93	•	



GL	1200	A, I Gold Wing	84- 86	•
GL	1200	DX Gold Wing	86-	•
GL	1200	Gold Wing	84- 86	•
GL	1500	A, SE, I Gold Wing	94-	•
GL	1500	Gold Wing, Gold Wing SE	88-	•
GLX	1500		88-	•
<b>SYM</b>				
	110	110	93	•
	125	125		•

# 3187 ORGANIC

## Brake Pads

A 49,1 | L 88,2 | S 7,8  
A 36,1 | L 56,1 | S 10,2

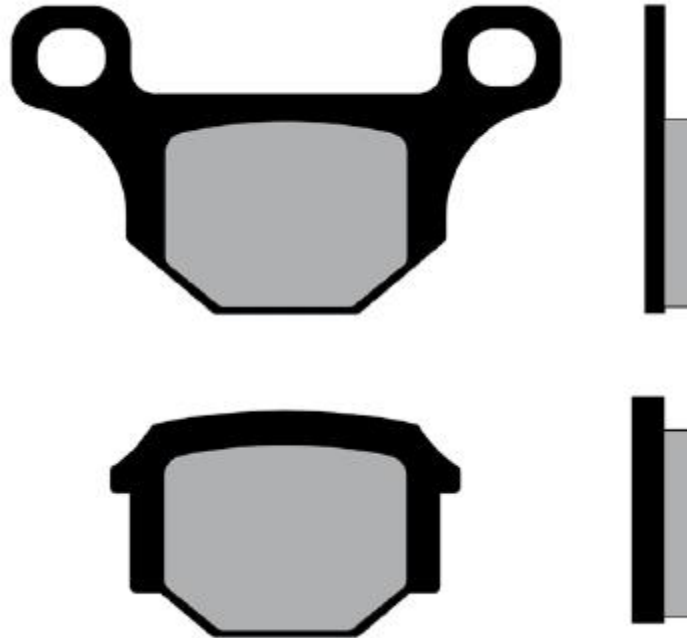

### APRILIA

RS-4	125	(AJP cal.)	11-	•
------	-----	------------	-----	---

### DERBI

	125	Mulhacen	08-	•
	125	Senda DRDSM	10-	•
	125	Terra	08-	•
	125	Terra Adventure	08-	•

### HAO-QING

	125	2C	02-	•
--	-----	----	-----	---

### JINCHENG

JC	125	7B	97-	•
----	-----	----	-----	---

### MASH

	125	Scrambler	13-	•
	125	Seventy	13-	•

### MOTORHISPANIA

RX	50		08-	•
MH7	125	Naked	08-	•
RX	125	R	08-	•

### RIEJU

	50	Spike X	08-	•	•
MRT	50		09-	•	•
MRT	50	Supemotard	09-	•	•
RRX	50		08-	•	•
	125	Marathon Pro	09-	•	•
	125	Marathon Pro Supemotard	09-	•	•

### SUZUKI

GN	125		82- 90	•
----	-----	--	--------	---



GN	125		05-	•
GS	125	E, Katana	90- 94	•
GS	125	ESD	83- 94	•
<b>TGB</b>				
	50	Bull&tRS/RR	11-	•
	50	Bullet	10-	•
	125	Bull&tRS/RR	11-	•





# 3189 ORGANIC

## Brake Pads

A 41,0 | L 114,9 | S 8,3

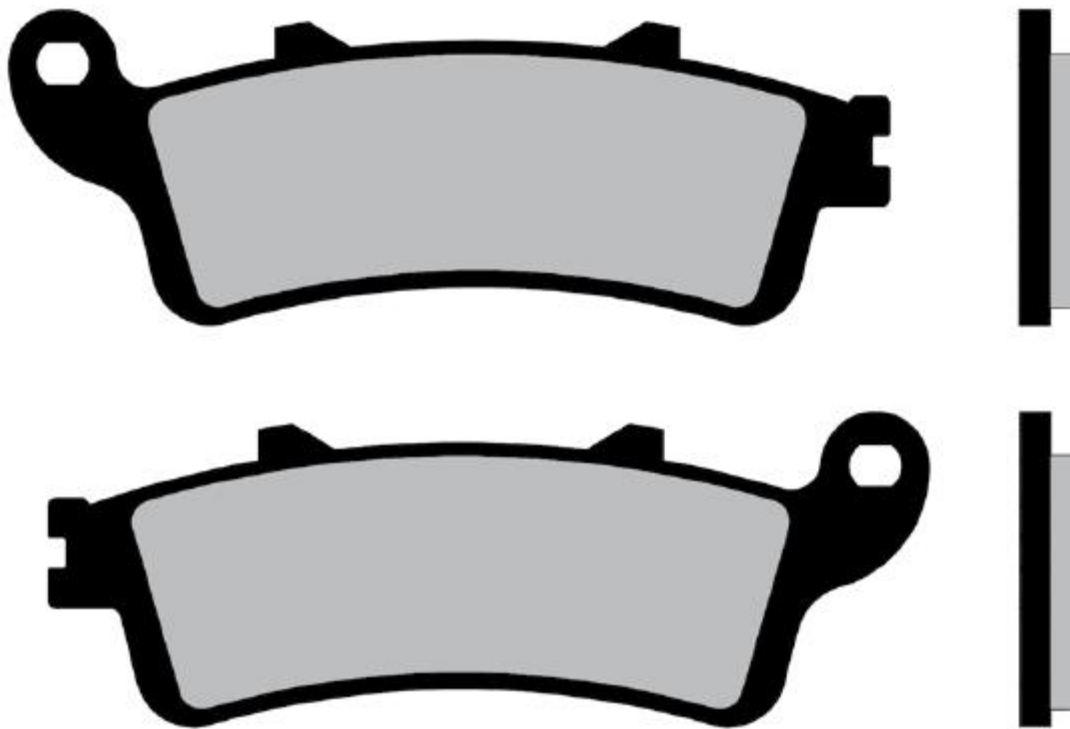

### HONDA

FES	250	Foresight	98- 07	•	
NSS	250		00- 04	•	
NSS	250	Forza	00- 04	•	
NSS	250	Jazz	01- 04	•	
FJS	400	Silverwing	06- 08	•	
FJS	600	Silverwing	01- 08	•	
NT	650	V Deauville	02- 05	•	
NT	700	Deauville ABS	06- 12	•	•
NT	700	V Varadero ABS	10-		•
VFR	800		06- 13		•
VFR	800	ABS	06- 13		•
VFR	800	FI	98- 01	•	•
VFR	800	V-TEC,ABS	02- 05	•	•
XL	1000	Varadero	99	•	•
XL	1000	Varadero	07-		•
XL	1000	Varadero ABS	04-		•
XL	1000	Varadero (Linked brake system)	00- 06	•	•
CB	1100	Hornet	99-	•	•
CB	1100	X-11	00- 03	•	•
CBR	1100	XX Super Blackbird	96-	•	•
ST	1100	A6 ABS- TCSCBS	96-	•	
ST	1300	Pan European ABS	02- 07	•	



VT	1300	CXAA Fury ABS	10- 12		.
GL	1800	Gold Wing	01-	.	
GL	1800	Gold Wing F6B	13-	.	
VTX	1800		01-	.	.
<b>KAWASAKI</b>					
	650	Ninja	17-	.	
EN	650	Vulcan S	15-	.	
EN	650	Vulcan S Cafe	17-	.	
EN	650	Vulcan SSE	17-	.	
<b>VICTORY</b>					
	1731	Vision all models	08-	.	
<b>PEUGEOT</b>					
	125	Looxor	03-	.	

# 3190 ORGANIC





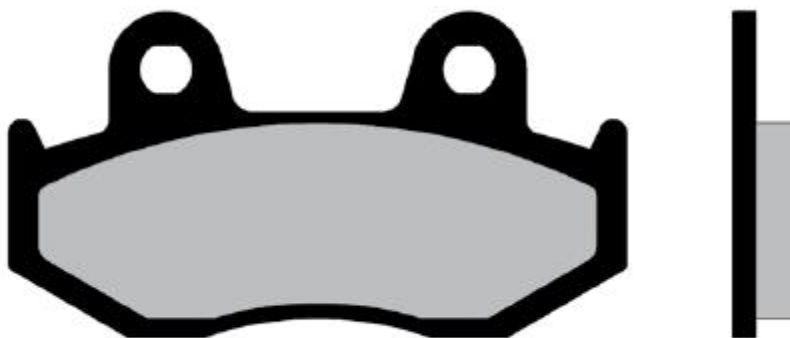

## Brake Pads

A 42,6 | L 81,6 | S 7,3



### HONDA

MBX	80		86-	•
MTX	80	R	87-	•
	100	Lead	00-	•
NHX	110		10-	•
CR	125	RE, RF	84- 85	•
CR	125	RG	86	•
MTX	125	R	84- 95	•
NES	125	@	01- 06	•
NES	150	@	01- 06	•
NSR	125	F	88- 89	•
XL	125	R	86	•
MTX	200	R	85-	•
ATC	250	R	85- 86	• •
ATC	250	X	85	•
CB	250	RS	85-	•
CH	250	Spacy	85- 86	•
CH	250	Spacy.Freeway Fusion	88-	•
CN	250	Spazio	88- 89	•
CR	250	RE, RF	84- 85	•
CR	250	RG	86	•
FIR	250		86-	• •
TRX	250	R	86- 89	•
TRX	250	X Fourtrax	87	•
XL	250	R	84- 87	•
XLR	250	R	88-	•
XR	250	R	84- 87	•
ATC	350	X	85	•
XL	350	R	84-	•
XR	350	R	84- 85	•
CR	500	RE, RF	84- 85	•

					
CR	500	RG	86	•	
XL	500	R	83-	•	
XR	500	R	86-	•	
XR	500	R, Pro Link	83- 84	•	
XL	600	R	83- 87	•	
XLM	600	LM	87-	•	
XR	600	R	83- 87	•	
<b>PGO</b>					
	50	T-Rex 3 (tr3 50)	02-	•	

# 3191 ORGANIC

## Brake Pads

A 43,0 | L 41,0 | S 5,3



### APRILIA

NA	850	Mana GT, ABS (Parking Brakes)	09- 13	•
SRV	850	(Parking Brake)	12-	•

### BMW

C		Evolution (Parking Brake)	12-	•
C	600	Sport (Parking Brake)	12- 15	•
C	650	GT (Parking Brake)	12- 15	•

### GILERA

RC	500	Fuoco ie (Parking Brake)	08-	•
GP	800	(Parking Brake)	08-	•

### HONDA

FJS	400	Silverwing (Parking Brake)	06- 08	•
FJS	600	Silverwing (Parking Brake)	01-	•
DN-01	680	(Parking Brake)	08-	•
CTX	700	D ABS w/DCT (Parking Brake)	14-	•
CTX	700	ND ABS w/DCT (Parking Brake)	14-	•
NC	700	D Integra w/DCT (Parking Brake)	12- 13	•
NC	700	SD ABS w/DCT (Parking Brake)	12- 13	•
NC	700	XD ABS w/DCT (Parking Brake)	12- 13	•
	750	A-ADV (Parking Brake)	17-	•
NC	750	D Integra w/DCT (Parking Brake)	14-	•
NC	750	Sw/DCT (Parking Brake)	14-	•
NC	750	Xw/DCT (Parking Brake)	14-	•
NM4	750	Vultus ABS w/DCT (Parking Brake)	15-	•
CRF	1000	L Africa Twin (Parking Brake)	16-	•
VFR	1200	Fw/DCT (Parking Brake)	10-	•
VFR	1200	XDC Crosstourer w/DCT (Parking Brake)	12-	•

### PIAGGIO

	125	MP3 (Parking Brake)	06- 07	•
	125	MP3 Efi (Parking Brake)	08- 11	•
	125	MP3 Hybrid (Parking Brake)	09- 12	•



125	MP3 Yourban (Parking Brake)	11- 12	•
250	MP3 (Parking Brake)	06- 07	•
250	MP3 Efi (Parking Brake)	08- 09	•
250	MP3 LT iE (Parking Brake)	09	•
300	MP3 Hybrid (Parking Brake)	11-	•
300	MP3 Hybrid iE (Parking Brake)	11-	•
300	MP3 iE (Parking Brake)	10-	•
300	MP3 LT (Parking Brake)	13-	•
300	MP3 LT Businnes (Parking Brake)	13-	•
300	MP3 LT Ie ABS (Parking Brake)	14-	•
300	MP3 LT Sport (Parking Brake)	14-	•
300	MP3 LT Touring (Parking Brake)	11- 12	•
300	MP3 Touring (Parking Brake)	11- 12	•
300	MP3 Yourban iE (Parking Brake)	11-	•
350	X10 Executive (Parking Brake)	13-	•
400	MP3 iE (Parking Brake)	07- 10	•
400	MP3 LT iE (Parking Brake)	09- 10	•
400	MP3 LT Touring (Parking Brake)	11- 12	•
400	MP3 Touring (Parking Brake)	11- 12	•
500	MP3 (Parking Brake)	10-	•
500	MP3 LT Touring Businnes (Parking Brake)	11- 13	•
500	MP3 LT Touring Businnes (Parking Brake)	14-	•
500	MP3 LT Touring Sport (Parking Brake)	11- 13	•
500	MP3 LT Touring Sport ABS (Parking Brake)	14-	•
500	MP3 LT Touring Businnes (Parking Brake)	11- 12	•
500	MP3 LT Touring Sport (Parking Brake)	11- 12	•
500	X10 Executive (Parking Brake)	13-	•

# 4192 SINTERED

## Brake Pads

A 36,0 | L 95,3 | S 7,6  
A 40,2 | L 109,6 | S 7,6

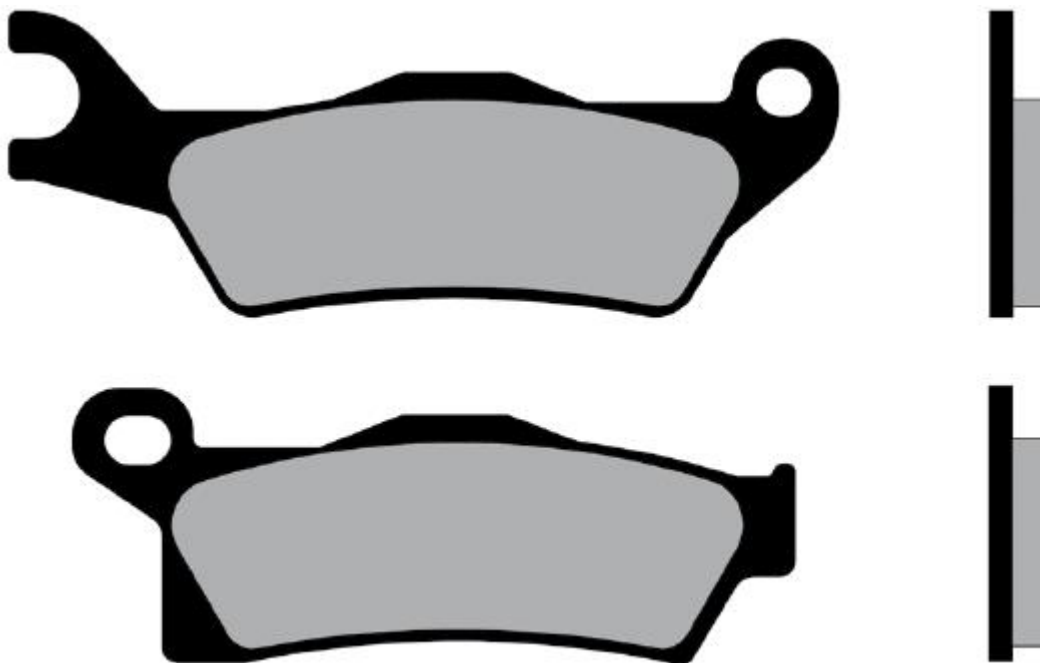

### CAN-AM

450	Outlander MAX Right/Rear	15-	•	•
450	Outlander Right/Rear	15-	•	•
500	Outlander MAX Right/Rear	13-	•	•
500	Outlander Right/Rear	13-	•	•
500	Renegade Right/Rear	12-	•	•
650	Outlander MAX Right/Rear	13-	•	•
650	Outlander Right/Rear	13-	•	•
800	Outlander MAX Right/Rear	13-	•	•
800	Outlander Right/Rear	12-	•	•
800	Renegade Right/Rear	12-	•	•
1000	Outlander MAX Right/Rear	12-	•	•
1000	Outlander Right/Rear	12-	•	•
1000	Renegade Right/Rear	12-	•	•

# 4193 SINTERED

## Brake Pads

A 36,0 | L 95,3 | S 7,6  
A 40,2 | L 109,6 | S 7,6

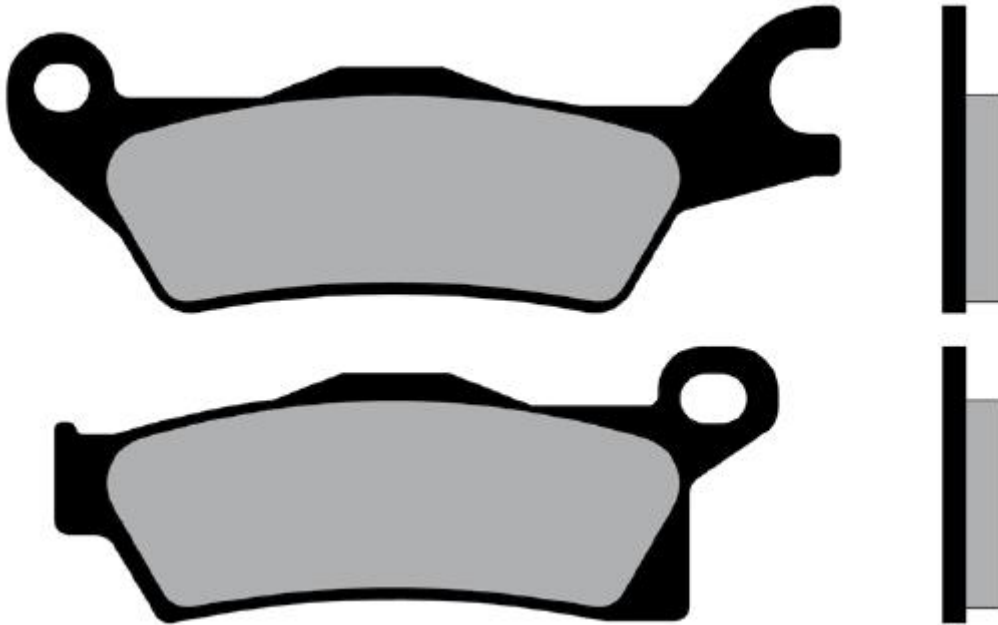

### CAN-AM

450	Outlander Left	15-	•	
450	Outlander MAXLeft	15-	•	
500	Outlander Left	13-	•	
500	Outlander MAXLeft	13-	•	
500	Renegade Left	12- 13	•	
500	Renegade Left/Rear	14-	•	•
650	Outlander Left	13-	•	
650	Outlander MAXLeft	13-	•	
800	Outlander Left	12-	•	
800	Outlander MAXLeft	13-	•	
800	Renegade Left	12- 13	•	
800	Renegade Left/Rear	14-	•	•
1000	Outlander Left	12-	•	
1000	Outlander MAXLeft	12-	•	
1000	Renegade Left	12- 13	•	
1000	Renegade Left/Rear	14-	•	•



brake shoes



brenta®

Brake shoes

024

Ø 150x25

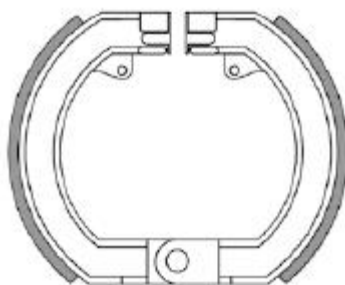

**PIAGGIO**

150	VESPA 150 SPRINT VELOCE	•
160	VESPA 160 GS	•
180	VESPA 180 SS	•
200	VESPA 200 RALLY	•

Brake shoes

087

Ø 127x23



**PIAGGIO**

125	VESPA 125	1951 → 1962	•
150	VESPA 150	1951 → 1962	•

Brake shoes

089

Ø 152x25



**INNOCENTI**

125	LAMBRETTA 125 II	•	•
150	LAMBRETTA 150 II	•	•
175	LAMBRETTA 175 II	•	•
175	LAMBRETTA 175 IV II		•

Brake shoes

0127

Ø 127x23

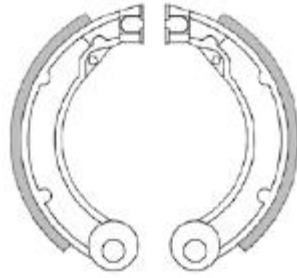

**PIAGGIO**

125	VESPA 125	1963 → 1972	•
150	VESPA 150	1963 → 1972	•

# Brake shoes

# 0128

Ø 150x24

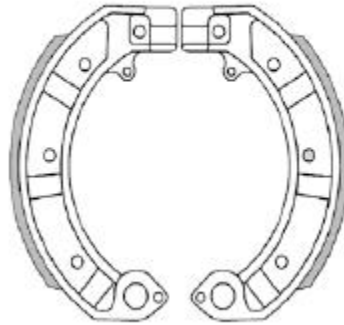

	50	HP	92-	•	•
	50	VFL2	90-	•	•
PK	50		83-		•
PK	50	Special	83-		•
PK	50	XL	86-		•
PK	50	XL2	86-	•	•
PK	125		83-	•	•
PK	125	Automatica	84-	•	
PK	125	Special	83-	•	•
PK	125	XL	86-	•	•
PX	125		78-	•	•
PX	125	Arcobalenco	83-	•	•
	150	Sprint Veloce	75-		•
PX	150		78-	•	•
PX	150	Arcobalenco	83-	•	•
GS	160		75-		•
SS	180		75-		•
	200	Rally	75-		•
PE	200		83-		•
PX	200	Arcobalenco	83-		•
PX	200	E	78-		•

Brake shoes

0130

Ø 125x20

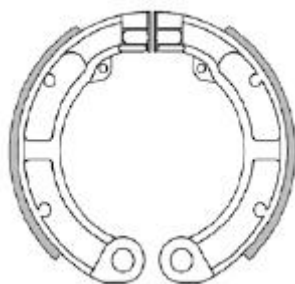

PIAGGIO

50

VESPA50

.

# Brake Pads

# 0151

Ø 90x18



## BENELLI

50	BOBO 50	1978	•	•
50	EXPORT 3 V 50	1979	•	•
50	G 2 50	1979	•	•
50	MOTORELLA 50	1979	•	•

## BETA

50	ANDY 50 ruote raggi	1978	•	•
50	ANDY 50 ruote lega	1978	•	•
50	B12 50	1973	•	•
50	MIO 50	1979	•	•

## FANTIC

50	ISSIMO 50 (ruote raggi)		•	•
----	-------------------------	--	---	---

## GARELLI

50	BASIC 50 (ruota raggi)		•	•
50	EUREKA 50		•	•
50	GULP 50		•	•
50	NOI 50 (ruota raggi)		•	•
50	NOI 50MATIC		•	•
50	SUPER VIP 50		•	•
50	VIP 50 (ruota raggi)		•	•

## GILERA

50	CB 1 50		•	
50	CBA 50		•	
50	CBA 50	1986	•	
50	ECO 50		•	

## MALAGUTI

50	CHOPPER 25 - 40 - 80 - FIFTY	1982		•
50	ciclomotori 50 all models	1983		•
50	LX 50SPORT	1982	•	
50	RCW 50 RONCO	1982		•
50	VA 50 OLYMPIQUE	1982		•
80	CHOPPER 80	1982		•



**MOTO GUZZI**

50	CHIU' 50	1974 → 1976	•	•
50	DINGO 50 3M	1966 → 1974	•	•
50	DINGO 50 M	1969 → 1973	•	•
50	DINGO 50 MM	1975 → 1976	•	•
50	DINGO 50 3 V	1975 → 1976	•	•
50	MAGNUM 50	1975 → 1976	•	•
50	TROTTER 50 SUPER	1966 → 1970	•	•
50	TROTTER 50	1966 → 1970	•	•
50	TROTTER 50 SPECIAL M - V	1971 → 1973	•	•
50	TROTTER 50 MARK M - V	1971 → 1973	•	•

**PIAGGIO**

50	FREE 50	1993 → 1995	•	
PIAGGIO (ciclomotori) 50	BOXER 50			•
PIAGGIO (ciclomotori) 50	BRAVO 50			•
PIAGGIO (ciclomotori) 50	CIAO 50			•
PIAGGIO (ciclomotori) 50	SI 50			•
PIAGGIO (ciclomotori) 50	SUPERBRAVO 50	1985		•
PIAGGIO (Spagna) 50	VESPINO 50	→ 1979	•	

**RIZZATO**

50	ATALA UNO 50 (ruota raggi)		•	•
----	----------------------------	--	---	---

**TOMOS**

83	K 83		•	•
83	M 83		•	•

# Brake Pads

# 0152

Ø 105x20



**BETA**

50	PULMAN 50	1970	•	•
----	-----------	------	---	---

**FANTIC**

50	SPRINTER 50 3V. R (FM. 248)	1983	•	•
50	SPRINTER 50	1984	•	•

**GARELLI**

50	JUNIOR 50 TURISMO (ruota raggi)		•	•
----	---------------------------------	--	---	---

**GILERA**

50	TREND 50	1989	•	
----	----------	------	---	--

**ITALJET**

50	SHOPPING 50	1990	•	
----	-------------	------	---	--

**PIAGGIO**

PIAGGIO (ciclomotori) 50	BRAVO 50 (ruote in lega)	1987	•	
PIAGGIO (ciclomotori) 50	CIAO 50 (ruote in lega)	1987	•	
PIAGGIO (ciclomotori) 50	GRILLO 50	1989	•	
PIAGGIO (ciclomotori) 50	SI 50 (ruote in lega)	1980	•	
PIAGGIO (ciclomotori) 50	SUPERBRAVO 50 3 Marce	1987	•	
PIAGGIO (Spagna) 50	VESPINO 50	1980	•	

**RIZZATO**

50	ATALA CALIFFONE 50 (ruota raggi)		•	•
----	----------------------------------	--	---	---

# Brake Pads

# 0154

Ø 118x20



## ACCOSSATO

50	50 CROSSMINI	1982	•	•
----	--------------	------	---	---

## APRILIA

50	ET 50	1984 → 1986	•	
50	RC 50	1983	•	•
50	RED ROSE 50	1988 → 1991		•
50	TUAREG 50	1984 → 1986	•	

## ASPES

50	CS 50 NAVAHO	1976	•	•
----	--------------	------	---	---

## BETA

50	FOUR50S	1987		•
50	FOUR50AE	1987		•
50	FOURTWIN50	1988		•
50	M4 50	1983		•
50	M6 50	1983		•
50	MS 50	1980		•
50	MX4 50 Special	1970	•	•
50	SCRAMBLER504M	1982	•	•
50	SQUIRREL 50	1983		•
50	TR 50	1980 → 1986	•	
80	TR 80	1980	•	







## FANTIC

50	TRIAL 50 I SERIE (mozzi centrali)	1983	•	
125	TRIAL 125 I SERIE. (tel. grig. m. cen)		•	

## GARELLI

50	CICLONE 50 I SERIE (ruota raggi)		•	•
50	CICLONE 50 II SERIE (ruota lega)		•	•
50	CICLONE 50 N/N DE LUXE SELF MIX L		•	•
50	CICLONE 50 N DE LUXE SELF MIX LC			•
50	GRAN TURISMO 50 (ruota lega)		•	•
50	KL 50 SV		•	•

## MALAGUTI

					
	50	CENTRO 50	1992	•	
	50	FIFTY 50 HF	1982		•
	50	FIFTY 50 FULL all models	1983		•
	50	FIFTY 50 TOP	1985		•
	50	FIFTY 50 HF	1987	•	•
	50	FIFTY 50 NL	1987	•	•
	50	FIFTY 50 4 MARCE	1987	•	•
	50	WC 50 WATERCOOLED	1982		•
<b>MOTO GUZZI</b>					
	50	DINGO 50 CROSS	1966 → 1974	•	•
	50	DINGO 50 SPORT	1966 → 1974	•	•
	50	DINGO 50 SUPER	1966 → 1974	•	•
	50	DINGO 50 TURISMO	1966 → 1974	•	•
	50	DINGO 50 GT	1966 → 1974	•	•
<b>RIZZATO</b>					
	50	ATALA CALIFFONE 50 (ruota in lega)		•	•
	50	ATALA MASTER 50 (ruota in lega)		•	•
<b>SWM</b>					
	50	TL 50 TRIAL	1983	•	•
	50	TR 50	1983	•	•
	80	TL 80 TRIAL	1983	•	•
	80	TR 80	1983	•	•

# Brake Pads

0159

Ø 150x24

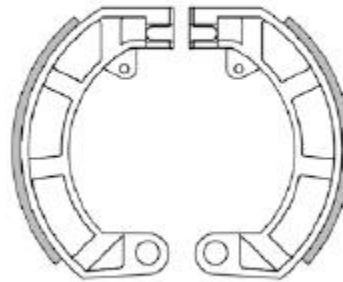

## PIAGGIO

50	VESPA 50 SPECIAL	•
90	VESPA 90 PRIMAVERA	•
125	VESPA 125 ET3	•
125	VESPA 125 PRIMAVERA	•

Brake Pads

0160

Ø 127x28

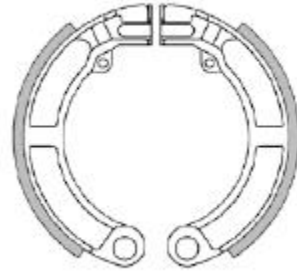

PIAGGIO

150

VESPA 150SUPER

.

# Brake Pads

# 0162

Ø 125x17



## PIAGGIO

50	VESPA 50 SPECIAL			•
50	VESPA 50			•
50	VESPA 50 PK SPECIAL - XL	1986		•
90	VESPA 90 PRIMAVERA			•
125	VESPA 125 PRIMAVERA			•
125	VESPA 125 ET3			•
125	VESPA 125	1951 → 1962	•	
125	VESPA 125	1963 → 1972	•	
150	VESPA 150 SUPER			•
150	VESPA 150	1951 → 1962	•	
150	VESPA 150	1963 → 1972	•	
PIAGGIO (motocarri) 50	APE 50 P	1980 → 1985	•	
PIAGGIO (motocarri) 50	APE 50 TM P	1985 → 1989	•	
PIAGGIO (motocarri) 50	APE 50 FL / FL2	1989 → 1995	•	
PIAGGIO (motocarri) 50	APE 50 FL3 EUROPA	1996 → 1999	•	
PIAGGIO (motocarri) 50	APE 50 RST MIX	1999 → 2005	•	
PIAGGIO (motocarri) 150	APE 150 C 1/2/3			•
PIAGGIO (motocarri) 150	APE 150 C4			•
PIAGGIO (motocarri) 175	APE 175 PENTARO			•
PIAGGIO (Spagna) 80	VESPA 80 PX			•
PIAGGIO (Spagna) 80	VESPA 80 SPECIAL			•
PIAGGIO (Spagna) 80	VESPA 80			•

# Brake Pads

# 0187

Ø 135x16



## GILERA

50	CB 1 50		•
50	CBA 50		•
50	CBA 50	1986	•
50	ECO50		•
50	TREND50	1989	•

## ITALJET

50	SHOPPING50	1990	•
----	------------	------	---

## PIAGGIO (ciclomotori)

50	BOSS 50	1988	•
50	BOXER50		•
50	BRAVO50		•
50	BRAVO 50 (ruote in lega)	1987	•
50	BRAVO 50 (ruote in lega mozzo 90mm)	1987	•
50	CIAO 50		•
50	CIAO 50 (ruote in lega)	1987	•
50	CIAO50MIX	1997	•
50	GRILLO50	1989	•
50	SI 50		•
50	SI 50 (ruote in lega)	1980	•
50	SI 50 MIX	1997	•
50	SUPERBRAVO50	1985	•



# Brake Pads

# 0266

Ø 100x20

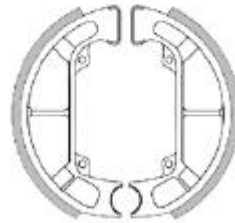

**GILERA**

	50	Easy Moving	96-	•
	50	Storm	94-	•
	50	Typhoon	93- 95	•
NRG	50		94-	•
	80	Typhoon	95-	•

**PIAGGIO**

	50	Quartz	92-	•
	50	Sfera	91-	•
	50	Storm	94-	•
	50	Typhoon	94- 95	•
	50	Zip	92- 93	•
	50	Zip & Zip	94-	•
NRG1	50		94- 95	•
TPH	50		93- 95	•
	80	Sfera	94-	•

# Brake Pads

# 0275

Ø 100x20



## GILERA

50	Typhoon	96-	•
----	---------	-----	---

## PIAGGIO

50	Zip Fast Rider	93- 95	•
----	----------------	--------	---

NRG	50	96- 00	•
-----	----	--------	---

NRG	50	97- 99	•
-----	----	--------	---

NTT	50	96-	•
-----	----	-----	---

RST	50	95-	•
-----	----	-----	---

TPH	50	96-	•
-----	----	-----	---

# Brake Pads

# 0300

Ø 140x25

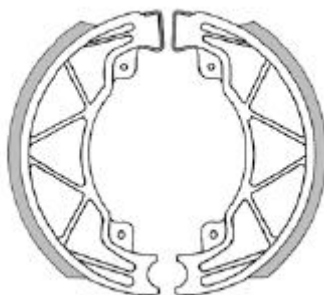

## APRILIA

	125	Habana/Custom	00- 02	•
	125	Mojito, Mojito Custom	02- 12	•
SR	125		99- 03	•
SR	150		00- 03	•

## DERBI

	125	Boulevard	03-	•
	150	Boulevard	03-	•

## GILERA

FX	125	Runner	97- 99	•
FX	150	Runner	97-	•
FX	200	Runner	97- 98	•

## PIAGGIO

	100	Fly	07-	•
	100	Zip	07-	•
	125	Fly	05-	•
LE	125	Liberty	99-	•
LX	125	Hexagon	99-	•
LX	125	Skipper, ST	99-	•
	150	Fly	06-	•
	150	Liberty	99-	•
LXI	180	Hexagon	99-	•

# Brake Pads

# 0303

Ø 140x25

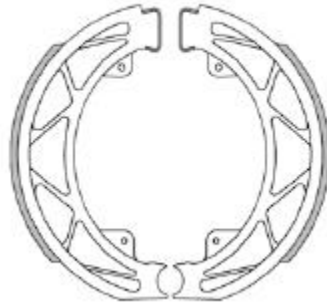

## PIAGGIO

50	Fly	05-	•
50	Liberty	97- 14	•
50	Liberty 4T	00-	•

# Brake Pads

# 0304

Ø 110x25



## APRILIA

	50	Amico, Scooter	92		•
--	----	----------------	----	--	---

## MBK

	50	Booster	- 94	•	•
	50	Booster Next Gen.	97-		•
	50	Booster Rocket	95- 02		•
	50	Booster Spirit	00-		•
	50	Booster Track	97- 02		•
	50	Evolis	92-		•
	50	Flipper	99-		•
	50	HotChamp	91-		•
	50	Ovetto	97- 10		•
	75	Active	90-	•	

## YAMAHA

	50	Beluga	90-	•	•
	50	Why	99-		•
BW	50		91- 94	•	•
BW	50	Bump	97-		•
BW	50	Next Generation	96- 07		•
BW	50	Spy	95-		•
CR	50	Z	91- 95		•
CW	50	TA Zuma	90	•	•
DT	50	MX	87- 90	•	•
DT	50	R	89- 97		•
IOG	50	CY	90- 92		•
IOG	50	R			•
T	50		86-	•	•
TRAFIC	50	M	83-	•	•
V	50	M	83	•	•
YA	50	Axis Mofa	97-		•
YM	50	Breeze, Fizz	95-		•
YN	50	Neo's, LC	97-		•



YF	60	S Moto 4	86	.
YT	60	Tri Zinger	84- 85	.
CH	80	Beluga (CH 80)	90-	.
DT	80	MX, MXS	84- 85	.
PW	80		83- 85	.
T	80	Townmate	83- 97	.
V	80	DL	83-	.
YEM	80		87- 88	.
AG	100	Farmbike	92- 93	.
RXS	100		83- 97	.
YEM	100	Champ	87- 88	.
	105	Crypton	98-	.
SR	125		92- 02	.
Y	125	Fair Breeze	92-	.

# Brake Pads







# 0305

Ø 110x25



## HONDA

CB	50	all models	80- 81		•
CB	50	all models	81	•	•
CB	50	J, K1	75- 79		•
MB	50	S	80- 82		•
MBX	50		80- 82		•
MBX	50	S	83- 85		•
MRX	50		88-		•
MT	50	S	80- 93	•	•
MTX	50	SC-SD	83- 84	•	•
NSR	50		89- 90		•
XL	50			•	•
NSR	75	FII	88- 00		•
XR	75	K4	75- 79	•	•
XR	75	K5	79-		•
CR	80	R2	85	•	•
CR	80	RA, RB	80- 81	•	•
CR	80	RC	82	•	•
MBX	80		83-		•
MBX	80	DX	82-		•
MBX	80	FWD	83- 86		•
MBX	80	SW, SWD	83-		•
MCX	80		82-		•
MTX	80	R	87-		•
MTX	80	RF	83- 84	•	•
XR	80		79- 84	•	•
C	90		93- 02	•	•
NH	90	Yupzy	90- 94		•
CB	100	N	79- 80		•
XL	100	all models	78- 85	•	•
XR	100		81- 84	•	•
CB	125	J	79-		•

					
CB	125	S	76- 78		•
CB	125	S	79- 82	•	•
CBX	125	Custom	88		•
CR	125	M2, M3, M4	76- 78	•	•
CT	125	C	85	•	•
MT	125	R			•
MTX	125	R	84- 95		•
MTX	125	R, Italy	86		•
MTX	125	RWD	83- 84	•	•
NX	125	Transcity	90- 98		•
R	125	Lead	88-		•
SL	125	K1D, E, F, G, K2A	76- 80	•	•
IL	125		76	•	•
XL	125	K2	78	•	•
XL	125	K3	79		•
XL	125	R	86		•
XL	125	R, P.D., Italy	85		•
XL	125	R, P.D., Italy, EX	87-		•
XL	125	S	79- 84	•	•
XLR	125	R	98-		•
XR	125	L	03-		•
CRF	150	F	03-		•
CBX	185	Custom	88-		•
XL	185	S	79- 83	•	•
CTX	200		04-		•
MTX	200	R	85-		•
MTX	200	RWD	83- 84	•	•
IL	200	J, Y	76- 78	•	•
TLR	200	Fatcat	86- 87	•	•
TLR	200	G, H	86- 87	•	•
TR	200		86- 87	•	•
XL	200	R	83- 84	•	•
XR	200		80- 84	•	•
XR	200	R	84- 02	•	•
XR	200	R, Pro Link	81- 83	•	•
CRF	230		04- 09		•
RTL	250	SG	86-	•	•
IL	250		75- 76	•	•
IL	250	K1	79	•	•
TLM	250	RJ	89	•	•
TLR	250	R	85-	•	•
XL	250	R	84- 87		•
XLR	250	R	88-		•
XR	250	R	84-		•
NX	350				•
XR	350	R	83-		•
XR	500	R, Pro Link	83- 84		•
XR	600	R	83- 90		•



# Brake Pads

# 0310

Ø 110x25



**PGO**

	50	Big Max	94- 02	•
	50	Big Max Sport	96-	•
	50	Comet	91-	•
	50	Galaxy	91-	•
PS	50		93	•
	90	Galaxy	92-	•
	100	Big Max	96-	•

**SUZUKI**

TR	50	Street Magic	97-	•
UG	110	Hokuto	00-	•

**SYM**

	125	Husky	96- 98	•
	125	Super Duke	95- 01	•
	150	Husky	99-	•

**TGB**

	50	202T	99-	•
--	----	------	-----	---

# Brake Pads

# 0311

Ø 130x25



## HONDA

NES	125	@	01-06	•
PCX	125		09-	•
PS	125	i	07-13	•
SES	125	Dylan	02-07	•
SH	125		02-08	•
NES	150	@	01-06	•
PCX	150		12-	•
PS	150	i	07-11	•
SES	150	Dylan	02-06	•
SH	150		02-08	•

# Brake Pads

# 01200

Ø 110x25



## APRILIA

	50	Amico	90- 91	•	•
	50	Amico,GI,GLE	93-		•
	50	Gulliver	96- 00		•
	50	Rally	95-		•
	50	Scarabeo Street	00-		•
	50	Scarabeo, 2nd series	94- 99		•
	50	Sonic, GP	99-		•
<u>AC</u>	50	Rally	95- 02		•
<u>LX</u>	50	Amico, Sport	92-		•
<u>SR</u>	50	Europa	93-		•
<u>SR</u>	50	Replica	94-		•
<u>SR</u>	50	Replica (Liquid Cooled)	96-		•
<u>SR</u>	50	Urban Kid	93-		•
<u>SR</u>	50	Viper	93-		•
<u>SR</u>	50	WWW, Netscaper	97-		•

## BENELLI

	50	Chrono	92-		•
	50	Nemo, Quadra	94-		•
	50	Pepe	99-		•
<u>491</u>	50	GT, Sport	98-		•
<u>491</u>	50	Naked	99-		•
<u>491</u>	50	ST	01-		•

## BETA

	50	Chrono 13	94- 99		•
	50	Quadra	95- 96		•
	50	Tempo	92- 96		•

## BS VILLA

<u>AX</u>	50		93-		•
<u>GZ</u>	50		93-		•

## CAGIVA

	50	City	92-		•
--	----	------	-----	--	---

**E-TON**







RXL	150	Viper		•
-----	-----	-------	--	---







**HERCULES**

	50	Gipsy, Splinter, Reggae		•
	50	Limbo		•
SR	50	Samba	•	•
SR	80	Samba	•	•

**HONDA**

	50	Sky Classic	00-	•
	50	Sky Vetro	00-	•
C	50	all models	75- 93	•
CF	50	Chaly	79	•
NH	50	Lead	- 83	•
NH	50	Lead (Drum vers.)	94-	•
PK	50	Walroo DX-SID	90- 01	•
R	50	Monkey	88-	•
SFX	50	Sport	96-	•
SGX	50	Sky DX	97-	•
SH	50	City Express	84- 96	•
SH	50	Scoopy	88-	•
SH	50	T	97	•
SJ	50	Bali	93- 98	•
SS	50	K2	75- 77	•
SS	50	ZB2	75- 80	•
ST	50	Dax	78- 93	•
ATC	70	K1	76- 77	•
C	70	all models	75- 83	•
CF	70	K2, C	78	•
ST	70	Dax	78- 93	•
	75	Yupy	90-	•
NF	75		79	•
SA	75	Vision	89-	•
SH	75	Scoopy	88- 95	•
XR	75	K5	79-	•
CH	80	Elite	85-	•
NH	80	Aero	85-	•
NH	80	MD Lead, Aero	83- 84	•
SH	80	Scoopy	88-	•
C	90	all models	75- 92	•
EZ	90	Cub	90- 95	•
TRX	90		93-	•
H	100	A, SD, SG, SJ	82- 92	•
SJ	100	Bali	97-	•
ANF	125	i Innova	07- 11	•
ANF	125	Innova	03- 06	•
ATC	125	ME, ME, MG, MH	84- 87	•
CB	125		72- 74	•
CB	125	S	84- 85	•
CG	125	A, B, C	77- 84	•
CG	125	E, F, J	85-	•
CH	125	D, E, Spacy, Elite	83- 84	•
MTX	125	Camel, Italy	88-	•
NH	125	Lead Scooter	86- 87	•
NH	125	Lead, Aero	83- 84	•
NS	125	Italy	85- 88	•
NSR	125	F	88- 89	•
RIV	125	NRS, Italy	87-	•
SL	125	K1A	76	•
TRX	125		85- 88	•

					
XL	125	K3	79	•	
CH	150	D Elite	85- 87	•	•
ATC	185	A, S, SB	80- 83	•	
ATC	200		81- 83	•	
ATC	200	E Big Red	82- 83	•	
ATC	200	ES Big Red	84	•	
ATC	200	M	84- 85	•	
ATC	200	S	84- 86	•	
XL	200	R, P.D., Italy	85-		•
<b>KTM</b>					
GO	50		94-		•
<b>KYMCO</b>					
	50	Agility	05- 08		•
	50	Agility (4T) R10	06-		•
	50	Agility (4T) R12	06-		•
	50	Agility Basic	07-	•	•
	50	Calypso	97-		•
	50	Cobra Cross	99-		•
	50	Cobra Exclusive	01-		•
	50	Cobra Racer	99-		•
	50	Dink, Dink Sport, B&W	99-		•
	50	Easy	01-		•
	50	Filly	99-	•	•
	50	Filly LX	01		•
	50	Heroism	95-		•
	50	Manboy	95-		•
	50	MXer	03-	•	
	50	MXU	05-	•	
	50	Refined	94-	•	•
	50	Scout	95-		•
	50	Sento	08- 10		•
	50	Spacer	99-		•
	50	Topboy on/off road	96-		•
	50	Topboy Racer/Cross	01-		•
	50	Yager	01-		•
	50	Yup	01		•
CX	50		94-	•	
DJ	50		99-	•	
DJ	50	Refined	99-	•	
DJW	50		94-	•	
DJX	50		91-	•	
DJY	50		93-	•	
K12	50		95-		•
KB	50		95-		•
	80	Filly	99-	•	•
	90	Manboy	96-		•
	100	Cobra Racer	99-		•
	100	Topboy on/off road	99-		•
KB	100		99-		•
	125	Agility	06-		•
	125	Calypso	99-		•
	125	Heroism	95-		•
	125	MXer	03-	•	
B	125	Freeway	93- 95		•
D2	125	Freeway	95-	•	•
	150	Freeway	95-		•
	150	MXer	03-	•	
	150	MXU	05-	•	
<b>MALAGUTI</b>					

					
	50	Centro	93-		•
	50	Ciak	00-		•
	50	Yesterday	97-		•
F-10	50		92- 93		•
F-10	50	Jet-Line	94-		•
F-12	50	Phantom	94- 98		•
F-12	50	Phantom A.C.	99-		•
F-12	50	Phantom L.C.	94- 98		•
F-15	50	Fire Fox	96-		•
F-15	50	Fire Fox L.C.	96-		•
SL	50	Centro	96-		•
<b>PEUGEOT</b>					
	50	Buxy e-Vivacity	11-		•
	50	Buxy (A.I.P. cal.)	94-		•
	50	Buxy (Brembo cal.)	94-		•
	50	Buxy (Hengtong cal.)	94-		•
	50	Elyseo (A.I.P. cal.)	99- 01		•
	50	Looxor	02- 05		•
	50	Ludix	04-		•
	50	Ludix (Drum front)	04-	•	•
	50	Metropolis	04-	•	
	50	Speedake (A.I.P. cal.)	94-		•
	50	Speedake (Brembo cal.)	94-		•
	50	Speedake (Hengtong cal.)	94-		•
	50	Speedfight 3 (AC)	10-		•
	50	Speedfight LC, (A.I.P. cal.)	96-		•
	50	Speedfight LC, (Brembo cal.)	96-		•
	50	Speedfight LC, (Hengtong cal.)	96-		•
	50	Squab (A.I.P. cal.)	94-		•
	50	Squab (Hengtong cal.)	94-		•
	50	Trekker Road	99-		•
	50	Tweet	10- 13		•
	50	V-Clic	08-		•
	50	Zenith	94-		•
	50	Zenith Luxe	94-		•
SC	50			•	
SV	50	APS	91	•	•
SV	50	Geo	91	•	•
SV	50	Geo	92-		•
SV	50	J,Junior	93-	•	•
SV	50	L	93-		•
SV	50	Roland Garros	93-		•
SV	50	Sport	93-		•
SX	50			•	
SC	75			•	
SX	75			•	
	80	Metropolis		•	
SC	80			•	•
SV	80	Geo	91-		•
SX	80			•	
SX	80	Pro		•	
	100	Elyseo (A.I.P. cal.)	99- 01		•
	125	Ludix	04-		•
SV	125	C Executive	96-		•
SV	125	Executive	94-		•
SV	125	Geo	91-		•
<b>PGO</b>					
	50	Star	91-	•	
	80	Star	91-	•	



**SYM**

	50	Fiddle	09-	•
	50	Jet Alpha	95-	•
	50	Jungle	96-	•
	50	Mask	00-	•
	50	Mask LC	00-	•
	50	Red Devil	97-	•
	50	Super Fancy	95- 97	•
RS	50		05-	•
	100	Super Fancy	95-	•
	125	Attila	95-	•
	150	Super Duke	96- 01	•

**YAMAHA**

	50	Axis Pro Foot	92-	•
XC	150	Fly One	92-	•

# Brake Pads

# 01205

Ø 110x25



## ADLY

25	Silver Fox	00- 05	•
50	Fox	00-	•
50	Jet	96-	•
50	Pista, Pista Twin Light	96-	•
50	Silver Fox	00-	•
100	Jet	96-	•
100	Silver Fox	06-	•

## BARIGO

	Scooter electric	97-	•
--	------------------	-----	---

## BENELLI

50	Naked	02-	•	
LX	100	Pepe	02-	•

## CPI

50	Baby	02	•
50	Hussar	01- 06	•
50	Mars	01-	•
50	Oliver	03-	•
50	Oliver City	03- 12	•
50	Oliver Sport	03- 12	•
50	Popcorn	01- 02	•

## DERBI

DXR	200	Quad (Front drum)	04-	•
DXR	250	Quad (Front drum)	04-	•

## EASY RIDER

50	Easy Rider	99-	•
----	------------	-----	---







## FANTIC







50	Pony	93-	•	•
50	Pony SR	93-	•	•
50	Queenie	95-	•	•

## GENERIC

50	Ideo	06- 13	
----	------	--------	--



					
	50	XOR	06- 13		
<b>KEEWAY</b>					
	50	Flash	07-		•
	50	Flash Electric	10-		•
	50	Hurricane	06-		•
	50	Matrix	06-		•
F-NKD	50		10-		•
RY8	50		07- 09		•
<b>KOTIR</b>					
RS	50		90-	•	•
<b>KREIDLER</b>					
	50	Florett	99-		•
<b>KTM</b>					
X-1	50		98-		•
<b>LEM</b>					
	50	Flash	94-		•
	50	Ghibli	90-	•	•
<b>MAICO</b>					
	50	Classic	99-	•	•
	50	Cruiser	99-		•
	50	Thunderbike I	99-		•
	50	Thunderbike II	99-		•
	50	Trafficjammer	99-	•	•
C-1	50	Hard Enduro	99-		•
R-1	50	Superbike	99-		•
X-1	50	SuperCross	99-		•
<b>MBK</b>					
	50	Equalis	96-		•
	50	Fizz	93-		•
	50	Forte	94-		•
	50	Sorriso	92-	•	•
	50	Target	92-		•
	80	Evolis	94-		•
	125	Flame R/F	95- 03		•
<b>POLARIS</b>					
		Trail Boss 2x4	85- 87	•	
	250	Cyclone	87	•	
<b>SMC</b>					
	50	Easy Rider	97-		•
<b>SULA</b>					
	50	City Bird	99-		•
	50	Thunder Bird	99-		•
	100	Thunder Bird	99-		•
	125	Thunder Bird	99-		•
<b>YAMAHA</b>					
CR	50	Target	91-		•
CX	50		88-	•	•
CY	50	F Jog	94		•
DT	50	LCD	98-		•
DT	50	R	98- 03		•
YE	50	Zest (Italy)	92- 95		•
YFM	50	Raptor	04-	•	
YSR	50		87- 91		•
	80	Beluga	- 89	•	•
CV	80	Riva	83- 87	•	•
CW	80	Beluga	81- 83	•	•
PW	80		91-		•
TY	80		83-		•
YFM	80		92- 94	•	

					
YFM	80	Badger	95-	•	
YFM	80	Grizzly	05-	•	
YFM	80	Raptor	02-	•	
YSR	80		86-		•
CR	90	Target	91-		•
TTR	90		00-		•
YFM	90	RY Raptor	09-	•	
RS	100	DX	77- 82		•
RT	100	A-H	90- 96	•	•
YB	100		82- 86		•
YB	100		87- 92	•	•
YFM	100	Champ	89- 91	•	
YZ	100		82- 83	•	
TTR	110		08-		•
SR	125	SE	82		•
TTR	125		00-	•	•
TTR	125	LW	00-		•
TW	125		99-		•
XT	125		82-		•
YFA	125	1 D, E Breeze	92- 93	•	
YFA	125	1 F Breeze	94	•	
YFA	125	1 G-M Breeze	95-	•	
YFA	125	1 W, A, B Breeze	89- 91	•	
YFM	125	Grizzly	04-	•	
XC	150	Fly One R	98-		•
YT	175	Tri Moto	82- 83	•	
SR	185	Exiter, H, J	81- 82		•
BW	200		85- 88		•
TT	200		86-		•
TW	200		87-		•
XT	200		85-		•
YFM	200	DXSDXWMoto4	86- 87	•	
YFM	200	N Moto 4	85- 89	•	
YFS	200	U-P Blaster	88- 02	•	
YTM	200	EK, EL Tri Moto	83- 84	•	
YTM	200	ERN Tri Moto	85	•	
YTM	200	K-N Tri Moto	83- 85	•	
TT	225	S,T	86- 00		•
TTR	225		01-		•
XT	225		92-		•
XT	225	Serow	86-		•
YFM	225	Moto 4	86- 88	•	
YTM	225	DRN, DRS Tri Moto	85- 86		
YTM	225	DXK, DXN Tri Moto	83- 85	•	
YFB	250	Timberwolf	92- 94	•	
YFM	350	ERT, ERU	87- 88	•	

# Brake Pads

# 01241

Ø 80x18



## HONDA

QA		K1-K3	87-	•	•
PA	50		78- 81		•
PA	50	50 Camino	80-	•	•
PF	50	50 MNocio	75-	•	•
PX	50		82-	•	

## KTM

SX	50	Adventure	98-	•	•
SX	50	Pro Junior LC	02-		•
SX	50	Pro Senior LC	02- 03		•
SX	50	Senior Adventure	04-		•

## MOTOBECANE

	50	all models	88- 89		•
--	----	------------	--------	--	---

## PEUGEOT

	50	103		•	•
	50	104		•	•
	50	105		•	•

## PUCH

	50	Cobra 6GT, GIL	80-		•
	50	Maxi 30 all models (excl. Spain)		•	•
	50	Maxi 40 all models		•	•
	50	Monza 4 GP, all models		•	•
	50	Monza 4 SL		•	•
	50	Monza 4 SL, GSL	80-		•

# Brake Pads

# 01284

Ø 110x25



## GILERA

	50	Eaglet	96	•
	50	Runner	97- 05	•
	125	Typhoon	96-	•

## PIAGGIO

	25	Zip II Cat DT	01-	•
	50	Zip Disco	96-	•
	50	Zip Fast Rider	96-	•
	50	Zip II	01-	•
	50	Zip II Cat DT	01-	•
ET2	50		97-	•
ET4	50		00-	•
LX	50	2T/4T	05-	•
	125	Hexagon	94- 95	•
	125	Sfera	95-	•
	125	Skipper	93- 95	•
	125	Zip II 4T	00-	•
ET4	125		96-	•
LX4	125	Hexagon	99-	•
TPH	125		96-	•
	150	Hexagon	94-	•

clutches



**brembo**<sup>®</sup>



Clutches





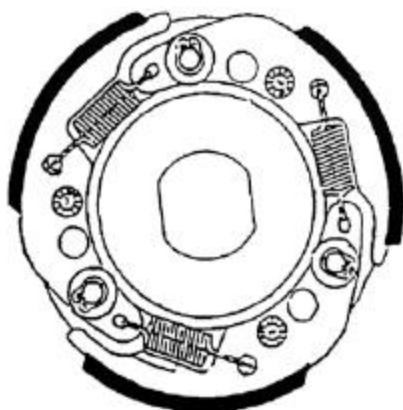

1001



Masette trascinamento **Ciao Piaggio** senza variatore.  
Serie formata da 3 pezzi.  
Disponibili con molle



Girante frizione con molle standard per campane diam. 105  
(Motori **Minarelli** prima del 1997)

					
<b>APRILIA</b>		All Models 50	< 97		
<b>BENELLI</b>		All Models 50	< 97		
<b>BETA</b>		All Models 50	< 97		
<b>CAGIVA</b>		All Models 50	< 97		
<b>ITALJET</b>		All Models 50	< 97		
<b>MALAGUTI</b>		All Models 50	< 97		
<b>MBK</b>		All Models 50	< 97		
<b>YAMAHA</b>		All Models 50	< 97		







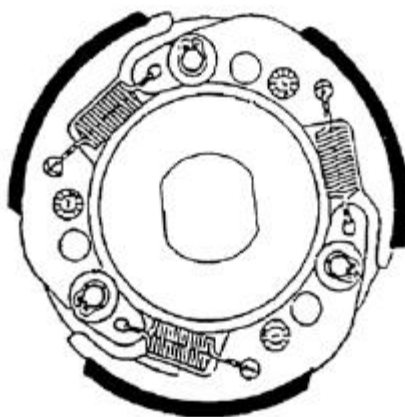

# Clutches

## 2005 R

per campane Ø 105



Girante frizione con molle a taratura rinforzata (colore Blu) per campane diam. 105  
(Motori **Minarelli** prima del 1997)

					
<b>APRILIA</b>		All Models 50	< 97		
<b>BENELLI</b>		All Models 50	< 97		
<b>BETA</b>		All Models 50	< 97		
<b>CAGIVA</b>		All Models 50	< 97		
<b>ITALJET</b>		All Models 50	< 97		
<b>MALAGUTI</b>		All Models 50	< 97		
<b>MBK</b>		All Models 50	< 97		
<b>YAMAHA</b>		All Models 50	< 97		

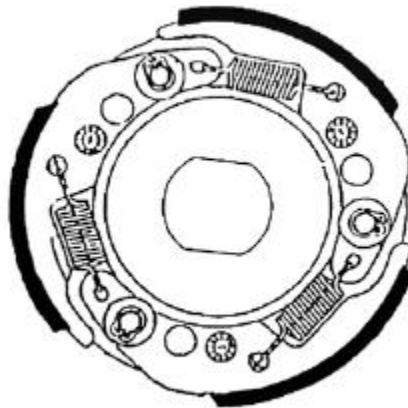

Girante frizione con molle standard per campane diam. 107  
(Motori **Piaggio** All Models e Motori **Minarelli** dopo il 1997)



<b>APRILIA</b>	All Models 50	97 >
<b>BENELLI</b>	All Models 50	97 >
<b>BETA</b>	All Models 50	97 >
<b>CAGIVA</b>	All Models 50	97 >
<b>GILERA</b>	All Models 50	
<b>HONDA</b>	All Models 50	
<b>ITALJET</b>	All Models 50	97 >
<b>KYMCO</b>	All Models 50	
<b>MALAGUTI</b>	All Models 50	97 >
<b>MBK</b>	All Models 50	97 >
<b>PEUGEOT</b>	All Models 50	
<b>PIAGGIO</b>	All Models 50	
<b>YAMAHA</b>	All Models 50	97 >





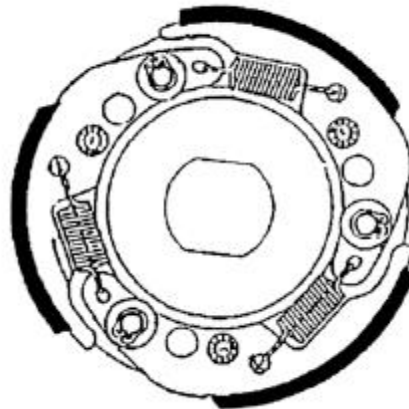

# Clutches

## 2007 R

per campane Ø 107



Girante frizione con molle a taratura rinforzata (colore Rosso) per campane diam. 107  
(Motori **Piaggio** All Models e Motori **Minarelli** dopo il 1997)

						
<b>APRILIA</b>		All Models 50	97 >			
<b>BENELLI</b>		All Models 50	97 >			
<b>BETA</b>		All Models 50	97 >			
<b>CAGIVA</b>		All Models 50	97 >			
<b>GILERA</b>		All Models 50				
<b>HONDA</b>		All Models 50				
<b>ITALJET</b>		All Models 50	97 >			
<b>KYMCO</b>		All Models 50				
<b>MALAGUTI</b>		All Models 50	97 >			
<b>MBK</b>		All Models 50	97 >			
<b>PEUGEOT</b>		All Models 50				
<b>PIAGGIO</b>		All Models 50				
<b>YAMAHA</b>		All Models 50	97 >			

# Clutches

## 2010

per campane Ø 110

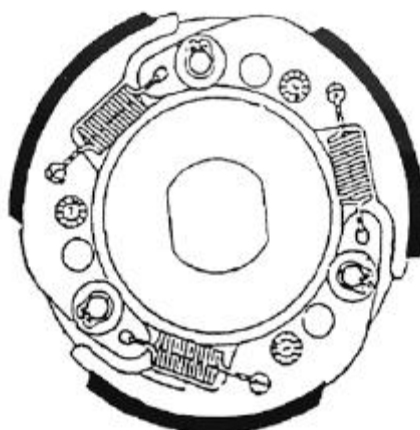

Frizione automatica con molle standard per campane diam. 110  
(Motori **Franco Morini**)



<b>ATALA</b>	All Models 50	< 97
<b>DERBI</b>	All Models 50	< 97
<b>SUZUKI</b>	All Models 50	< 97



# Clutches

## 2017 RL

per campane Ø 107

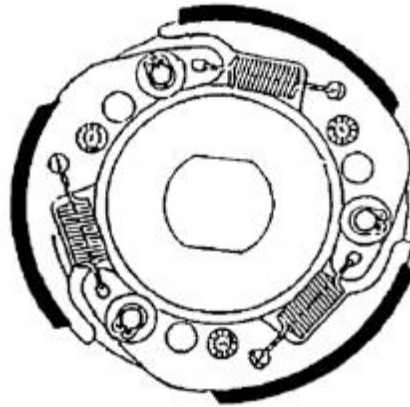

Girante frizione con massette e piatto alleggeriti e molle tarate (colore Verde) per campane diam. 107  
(Motori **Piaggio** All Models e Motori **Minarelli** dopo il 1997)



<b>APRILIA</b>	All Models 50	97 >
<b>BENELLI</b>	All Models 50	97 >
<b>BETA</b>	All Models 50	97 >
<b>CAGIVA</b>	All Models 50	97 >
<b>GILERA</b>	All Models 50	
<b>HONDA</b>	All Models 50	
<b>ITALJET</b>	All Models 50	97 >
<b>KYMCO</b>	All Models 50	
<b>MALAGUTI</b>	All Models 50	97 >
<b>MBK</b>	All Models 50	97 >
<b>PEUGEOT</b>	All Models 50	
<b>PIAGGIO</b>	All Models 50	
<b>YAMAHA</b>	All Models 50	97 >

## Cross References

BRENTA 	BREMBO	EBC	FERODO	NEWFREN	SBS
FT 3010	07BB1710	FA 193	FDB 680	FD.0196	725 / 697
FT 3011	07BB1710	FA 206	FDB 889	FD.0197	667
FT 3012	7009	FA 116	FDB 697	FD.0098	607
FT 3013	7008	FA 99	FDB 436	FD.0074	595
FT 3014	7019	FA 260	FDB 2057	FD.0249	724
FT 3015	07BB1205	FA 115	FRP 405	FD.0094 + FD.0142	559
FT 3016	07BB0810	FA 268	FDB 2062	FD.0251	731
FT 3017	7012	FA 194	FDB 677	FD.0195 / FD.0281	689
FT 3018	7037	FA 283	FDB 2085	FD.0264	146 / 740
FT 3019	07YA3408	FA 199	FDB 2003	FD.0205	691
FT 3020	7020	FA 298	FDB 2090	FD.0267	747
FT 3021	7033	FA 197	FDB 2087	FD.0257 + FD.0208	688
FT 3022	7043	FA 275	FDB 2083	FD.0259	728
FT 3023	7034	FA 281	FDB 2075	FD.0255	722
FT 3024	7047	FA 321	FDB 2115	FD.0298	772
FT 3025	7013	FA 186	FDB 784	FD.0194 / FD.0266	680
FT 3026	7006	FA 256	FDB 438	FD.0091 / FD.0238	588
FT 3027	07BB0410	FA 181	FDB 2018	FD.0186	671
FT 3028	7021	FA 301	FDB 2095	FD.0271	748
FT 3029	07BB0106	FA 47	FDB 207/R / 705	FD.0012	519
FT 3030	07BB1507	FA 95	FRP 408	FD.0093	566
FT 3031	07GR5605	FA 126	FDB 498	FD.0115	601
FT 3032	07GR705D-SX	FA 325	FDB 2183	FD.0372	794
FT 3033		FA 352		FD.0252	
FT 3034	7038	FA 323	FDB 2119	FD.0304	558
FT 3035	07BB2010	FA 266	FDB 2074	FD.0256 / FD.0357	730
FT 3036	7051	FA 356	FDB 2140	FD.0328	776
FT 3037	7050	FA 355	FDB 2141	FD.0327	775
FT 3038				FD.0336	
FT 3039	07GR5105	FA 291	FDB 2103	FD.0268	815
FT 3040	07GR5804	FA 303	FDB 2109	FD.0292	802
FT 3041	7056	FA 353	FDB 2142	FD.0330	786
FT 3042	07GR4804	FA 351	FDB 2127	FD.0315	803
FT 3043	7054	FA 374	FDB 2147	FD.0334	780
FT 3046	07HO485D-SX	FA 346	FDB 2139	FD.0329	777
FT 3047	7055	FA 411	FDB 2132	FD.0326	781
FT 3048	7048	FA 350	FDB 2128	FD.0323	773
FT 3049	7022	FA 305	FDB 2096	FD.0269	749
FT 3050	07KA1705	FA 185	FDB 892	FD.0193	694
FT 3051	7057	FA 256	FDB 2146	FD.0335	793
FT 3052	07KS0507	FA 63	FDB 338	FD.0060	556
FT 3053	07YA1107	FA 88	FDB 337	FD.0068	555
FT 3054	07YA1107	FA 161	FDB 338	FD.0086	556
FT 3055	07GR1406	FA 167	FDB 706	FD.0162	652
FT 3056	07BB2750	FA 368	FDB 2165	FD.0348	791
FT 3057	07YA2709	FA 179	FDB 781	FD.0183	663
FT 3058	7052	FA 319	FDB 2126	FD.0316	169
FT 3059	07HO3005	FA 142	FDB 570	FD.0132 / FD.0373	627
FT 3060	07SU1907	FA 188	FDB 873	FD.0199	686
FT 3061	07KA0808	FA 85	FDB 339	FD.0072	557
FT 3062	07KA1306	FA 158	FDB 574	FD.0143	631
FT 3063	07SU1215	FA 135 / 214	FDB 497	FD.0122	611

BRENTA 	BREMBO	EBC	FERODO	NEWFREN	SBS
FT 3064	07YA2008	FA 165	FDB 631	FD.0163	638
FT 3067	07BB1810	FA 193	FDB 2081	FD.0263	744
FT 3069	7027	FA 86	FDB 312	FD.0075	551
FT 3070	07SU1215	FA 228	FDB 497	FD.0230	713
FT 3071	07HC3109	FA 196	FDB 664	FD.0130 / FD.0325	
	07HC3405			/ FD.0250	700
	07HO4108				
FT 3072	07HC3607	FA 174	FDB 754	FD.0172 / FD.0324	657 / 753
FT 3073	07HO2711	FA 140	FDB 531	FD.0136	614
FT 3074	07KA0717	FA 83	FDB 313	FD.0085 / FD.0061	544
FT 3075	07HO1118	FA 83/2	FDB 313	FD.0226	548
FT 3076	7041	FA 169	FDB 636	FD.0175	619
FT 3077	7068	FA 393		FD.0414	823
FT 3078	7059	FA 408	FDB 2200	FD.0378	812
FT 3079	7059	FA 425	FDB 2207	FD.0394	831
FT 3080	7065	SFA 430		FD.0396	837
FT 3081	7063	FA 388	FDB 2196	FD.0400 / 385	828
FT 3082	764	FA 415	FDB 2212	FD.0401	832
FT 3083	07HC0906	FA 54	FDB 250	FD.0080	536
FT 3084	07BB28SP	FA 363	FDB 2039	FD.0229	742
FT 3085	07YA1407	FA 101	FDB 383	FD.0124	575
FT 3086	07KA1207	FA 152	FDB 659	FD.0144	632 / 648
FT 3087	07HO2608	FA 131	FDB 539	FD.0114 / FD.0192	604
FT 3088	07BB0210	FA 208 / FA 213	FDB 2005	FD.0206	675
FT 3089	07KA1617	FA 192	FDB 2012	FD.0207	687
FT 3090	07BB0306	FA 209	FDB 2006	FD.0216	674
FT 3091	07KA1817	FA 231	FDB 2049	FD.0227	704
FT 3092	07KA1907	FA 229	FDB 2048	FD.0228	705
FT 3093	07BB1907	FA 244	FDB 2042	FD.0221	706
FT 3094	07YA2307	FA 252 / FA 380 HH	FDB 605	FD.0190	634 / 198
FT 3095	07KS0432	FA 382 FA 67/3	FDB 314	FD.0073	682 / 586
FT 3096	7045	FA 324	FDB 2105	FD.0282	761
FT 3097	7060	FA 418	FDB 2186	FD.0365	818
FT 3098	07GR7707	FA 482	FDB 2216	FD.0404	844
FT 3099	7005	FA 264	FDB 2190	FD 0219	708
FT 3100	7069	FA 427	FDB 2226	FD 0417	847
FT 3101	07YA41SDSX	FA 367	FDB 2162	FD.0349	790
FT 3102	7085	FA 607	FDB 2254	FD 0445	863
FT 3103	7040	SFA 498	FDB 2248	FD 0460	204
FT 3104	7058	FA 412	FDB 2173	FD 0356	182
FT 3105	07YA47	FA 450	FDB 2218	FD 0411	840
FT 3106	07HO2205	FA 084	FDB 661	FD 0078	592
FT 3107	07BB0510	FA 322/4	FDB 2120	FD 0305	762
FT 3108	07GR49	FA 307	FDB 2148	FD 0301	754
FT 3109	07GR49	FA 413	FDB 2148	FD 0424	835
FT 3110	07GR50	FA 317	FDB 2149	FD 0318	767
FT 3111	07GR50	FA 414	FDB 2149	FD 0425	836
FT 4112	07HO4507	FA 265	FDB 2079	FD 0300 / FD.0258	734
FT 4113	07BB3050	FA 447	FDB 2218	FD 0415	841
FT 4114	07HO59	FA 436	FDB 2221	FD 0412	834
FT 4115	07KA28	FA 417/4	FDB 2220	FD 0419	838
FT 4116	07HO50	FA 390	FDB 2205	FD 0364	809
FT 4117	07SU27	FA 379	FDB 2178	FD 0362	806
FT 4118	07YA46	FA 442/4	FDB 2217	FD 0407	839
FT 4119	07SU26	FA 369/4	FDB 2164	FD 0352	788
FT 4120	07KA2305	FA 347	FDB 2158	FD 0351	782
FT 4122	07BB33		FDB 2255	FD 0466	870
FT 4123	07BB2607	FA 335	FDB 2125	FD 0320	796



BRENTA 	BREMBO	EBC	FERODO	NEWFREN	SBS
FT 4124	07GR6207	FA 294	FDB 2124	FD 0319	778
FT 4125	07GR05		FDB 2206	FD 0398	861
FT 4127	07SU1407	FA 145 / FA 236	FDB 557	FD 0129	624
FT 4128		FA 435/4	FDB 2166	FD 0370	805
FT 4129	07HO13	FA 488	FDB 2253	FD 0446	862
FT 4130	07HO90	FA 603	FDB 2256	FD 0467	205
FT 4131	07SU32	FA 419	FDB 2213	FD 0402	883
FT 3132	07HO8807	FA 257	FDB 625	FD 0173	670 / 115
FT 3133	07GR5209	FA 377	FDB 2184	FD 0384	810
FT 3134	07SU1005	FA 110	FDB 436	FD 0100	587
FT 4135	07YA1711	FA 123	FDB 449	FD 0104	590
FT 4136	07H82807	FA 187	FDB 858	FD 0198	622
FT 4137	07KA2107	FA 254	FDB 2111	FD 0272	715
FT 4138	07YA3507	FA 123	FDB 662	FD 0177	613
FT 3139	07YA3908	FA 319	FDB 2156	FD 0345	769
FT 3140		SFA 608		FD 0422	877
FT 3141	07BB1410	FA 018	FDB 148	FD 0013	506
FT 3142	07GR72	FA 399	FDB 2210	FD 0380	821
FT 3143	07HO23	FA 124	FDB 452	FD 0452	600
FT 3144	07GR50	FA 428	FDB 2235	FD 0426	816
FT 4135	07BB38	FA 630	FDB 2265		900
FT 3146	07O93	FA 492	FDB 2264	FD 0486	208
FT 3147	07HO56	FA 375	FDB 2169	FD 0355	797
FT 3148	07YA25	FA 172	FDB 737	FD 0167	650
FT 3149	7062	FA306	FDB 2108	FD 0293	178 / 792
FT 3150	7109		FDB 2279	FD 0514	221
FT 3151	07HO61	FA 629	FDB 2275	FD 0502	915
FT 3152	07YA28	FA 464	FDB 2238	FD 0437	858
FT 3153	7092	FA 632		FD 0487	207
FT 3154	07GR18	FA 606	FDB 2266	FD 0497	877
FT 3155	07HO53	FA 496	FDB 2258	FD 0470	881
FT 4157	07PO02			FD 0280	716
FT 4158	07PO01	FA 159	FDB 2055	FD 0302	642
FT 4159	07GR16	FA 602	FDB 2257	FD 0464	872
FT 4160	07GR69	FA 357	FDB 2157	FD 0354	783
FT 4161	07GR20	FA 612	FDB 2262	FD 0481	885
FT 4162	07GR03	FA 645	FDB 2242	FD 0444	859
FT 4163	07HD07	FA 458	FDB 2251	FD 0436	854
FT 4164	07HD18	FA 434	FDB 2202	FD 0416	846
FT 4165	07HD16	FA 400	FDB 2097	FD 0389	826
FT 4166	07HD13	FA 381	FDB 2179	FD 0387	807
FT 4167	07HD14	FA 387	FDB 2180	FD 0386	808
FT 4168	07HD21	FA 643	FDB 2018	FD 0528	924
FT 5169		GP FA X 611	FDB 2228		845
FT 4170	07HD20	FA 296	FDB 2114	FD0533	860
FT 4171		FA 409	FDB 2210	FD 0405	830
FT 4172	07HD15	FA 457	FDB 2250	FD 0443	853
FT 4173		FA 634			
FT 3174	7101		FDB 2291	FD 0489	893
FT 4175	07YA52	FA 663	FDB 2280	FD 0515	931
FT 4176	07HO62	FA 679	FDB 2294	FD 0521	940
FT 3177					
FT 3178	7112	SFA 655	FDB 2296	FD 0517	222
FT 3179	7111	SFA 652	FDB 2297	FD 0518	223
FT 3180	7102	SFA 625	FDB 2289	FD 0519	216/925
FT 3182			FDB 2290		226
FT 3183	7031	FA 151	FDB 2192	FD 0139	110
FT 3184					

					
FT 3185	07HO18	FA 069/2	FDB 538	FD 0058	127 / 572
FT 3186	07HO10	FA 069/3	FDB 244	FD 0054	160 / 542
FT 3187	07GR09	FA 093	FDB 384	FD 0077	203 / 585
FT 3188	7103	SFA 628	FDB 2292	FD 0490	218
FT 3189	07HO43	FA 261 HH	FDB 2073	FD 253 / 254	156 / 735 / 736
FT 3190	07HO15	FA 323/3	FDB 382	FD 256 / 357	730
FT 3091	7094	SFA 257/2		FD 0439	209 / 879
FT 4192	07GR26	FA 618	FDB 2273	FD 505	910
FT 4193	07GR27	FA 617	FDB 2274	FD 506	911



**brenta**<sup>®</sup>  
brake evolution



made in Italy  prodotti italiani

DISTRIBUTED BY



 **frenotecnica**  
s.r.l.

Uff. Amm. / Sede legale / Produzione: V.le Caproni, 15 · 38068 Rovereto TN · Italy  
++39.0464.466296 · info@frenotecnica.it  
www.frenotecnica.it · www.brentafreni.it  
Azienda certificata TÜV ISO 9001:2015